

---

This is a reproduction of a library book that was digitized by Google as part of an ongoing effort to preserve the information in books and make it universally accessible.

Google™ books

<https://books.google.com>



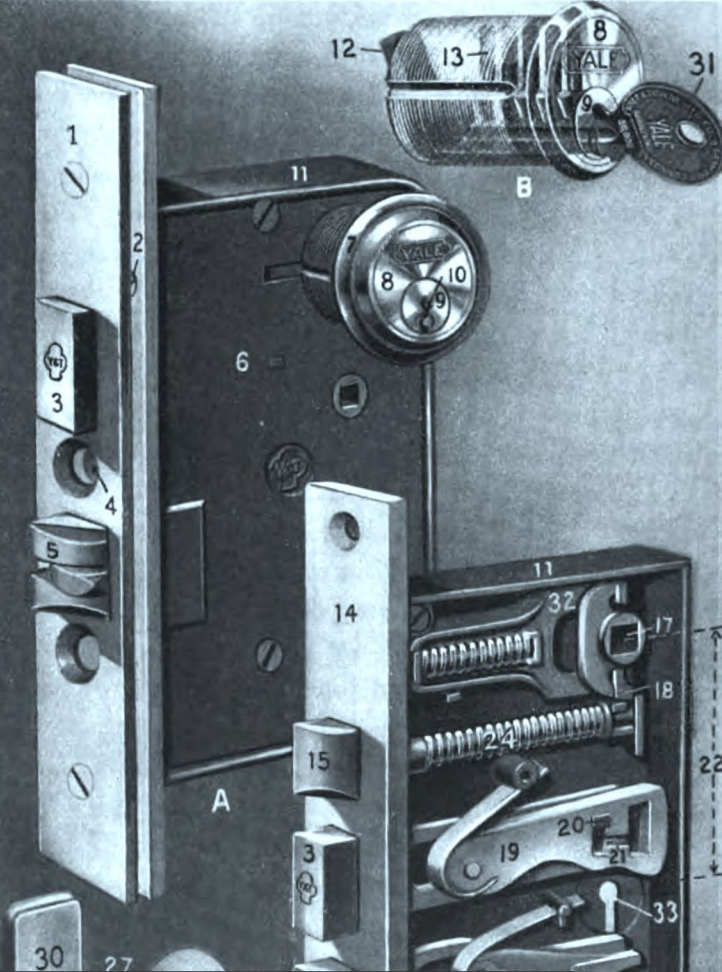

*Locks and builders hardware*

Henry Robinson Towne



**ANNEX**

Towre







2nd RL  
6/24 11/18

# Locks and Builders Hardware

*A Hand Book for Architects*

BY

HENRY R. TOWNE

President THE YALE & TOWNE MANUFACTURING COMPANY  
Past President Am. Soc. Mechanical Engineers

*Profusely Illustrated*

NEW YORK

JOHN WILEY & SONS

LONDON: CHAPMAN & HALL, LIMITED

1904 J.  
p. 1

DUPLICATE  
TO BE KEPT.



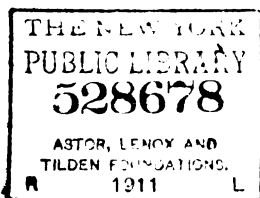

COPYRIGHTED 1904  
BY  
HENRY R. TOWNE.

NEW YORK  
PUBLIC LIBRARY  
ASTOR, LENOX AND  
TILDEN FOUNDATIONS

PRESS OF  
GILLESPIE BROS.,  
STAMFORD, CONN.

TO  
AMERICAN ARCHITECTS,  
WHOSE GENEROUS ENCOURAGEMENT HAS AIDED EVERY EFFORT FOR THE  
MECHANICAL AND ARTISTIC ADVANCEMENT OF  
AMERICAN HARDWARE,  
WITH THE PREVIOUS PERMISSION OF SOME,  
AND IN THE HOPE THAT IT MAY BE USEFUL TO ALL,  
THIS BOOK IS DEDICATED  
BY  
THE AUTHOR.

COPIES OF THIS BOOK MAY BE OBTAINED FROM ANY BOOKSELLER,  
OR FROM THE PUBLISHERS,  
JOHN WILEY & SONS,  
43 AND 45 EAST NINETEENTH STREET, NEW YORK.  
PRICE, . . . \$3.00.

## PREFACE.

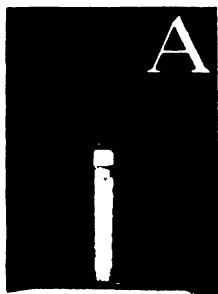

WIDE acquaintance with members of the architectural profession, and a long familiarity with their wants in the field of Builders' Hardware, both as to the product itself and as to information pertaining to it, is the excuse for offering this combined Hand Book of technical information and ready-reference Catalogue of Locks and Hardware; an experience of over thirty years as a manufacturer may serve as a justification for attempting what the volume aims to accomplish.

Its matter and arrangement will speak for themselves. The author's share of the work has been done during the intervals of a busy life, as occasion permitted. A most valuable feature is the series of articles on the Schools of Ornament by Mr. W. W. Kent, architect, while additional articles of interest are from the pens of other qualified writers. To the intelligent assistance of Mr. C. S. Redfield is due the credit of compilation, arrangement and general supervision of the work. The volume as a whole sets forth, more completely than any previous publication, the development and achievements of an industry which can justly claim a prominent place in the Building Trades, which in its latest phase has boldly and successfully entered the domain of Art, and which, to an exceptional degree, is typical of American ingenuity, skill and progress.

For the proper exposition of the subject of Builders' Hardware, especially in its practical relation to the work of the architect, it became necessary to refer, specifically and in detail, to concrete examples of the product it embraces. To have omitted all such reference would have made the volume of little practical value; to have selected diverse examples from the product of various manufacturers would have been confusing, illogical and contrary to actual practice; if the product of one establishment was to be used for purposes of illustration it was expedient that the author should avail of the one with which he is most familiar. Therefore he has not hesitated to avail frankly of the product of the works operated under his management.

If it serves in any degree to promote a broader appreciation of the comprehensive product of which it treats, to facilitate the intelligent use thereof by Architects and their clients, and to enlarge the technical knowledge of Builders and Dealers, this volume will have accomplished the purposes for which it is intended.

HENRY R. TOWNE.

*New York, 121 Madison Ave.,  
November, 1904.*

# CONTENTS.

PART	PAGE
Preface, Glossary, etc., . . . . .	3
I. Narrative and Historical, . . . . .	38
II. Mechanics of Hardware, . . . . .	104
III. Art Metal Work and Ornament, . . . . .	226
IV. Locks and Latches, . . . . .	614
V. Locks in Sets, . . . . .	680
VI. Plain Hardware, . . . . .	762
VII. Hardware Groups, . . . . .	822
VIII. Cabinet Hardware, . . . . .	962
IX. Specifications, etc., . . . . .	994
X. Miscellaneous Information, . . . . .	1058
<hr/>	
GENERAL INDEX, . . . . .	1094
NUMERICAL INDEX, . . . . .	1104

# Introductory.

---

## THE PURPOSE AND ARRANGEMENT OF THE BOOK EXPLAINED.

---

### **Builders' Hardware.**

American usage has adopted the term "Builders' Hardware" to designate that large group of metal products, used in buildings, which relates to *protection, convenience and decoration*, as distinguished from the heavier and simpler material of construction, such as columns and beams, or nails and screws.

The former usually is, and always should be, reserved for careful and personal selection by the architect, alone or in conjunction with his client, while the latter is furnished by the contractor in conformity with the general specifications.

### **Protection.**

The primary function of Builders' Hardware is to supply proper and convenient fastenings for doors and windows, whereby at will they may be closed so as to secure protection and privacy.

Hence, Locks, in their many diverse forms, become the natural basis of the line of products designated as Builders' Hardware, and constitute its most important element, although Bolts, Catches, Sash Fastenings and other fastening appliances are equally necessary.

### **Convenience.**

The next requirement is that these articles, in addition to affording protection, shall be convenient in use, and a vast amount of ingenuity has been devoted to this end with the result that American hardware, to a marked degree, is characteristic of the national skill in adapting means to ends, especially in the field of applied mechanics.

**Decoration.**

The final requirement, that the articles which are visible shall not only harmonize with their surroundings but shall also constitute an element in the general scheme of decoration, is one which, although only intelligently recognized by us since 1876, is now more completely attained by American hardware, especially that made by the leading manufacturers, than by the corresponding product of any other country. This statement is made unqualifiedly and covers the most creditable, as it is the latest, achievement of the industry concerned.

**Division  
of subject.**

The three essentials of good hardware, which we have thus briefly indicated, are so interwoven and interdependent as to preclude their further separate consideration, except only as to the element of decoration, and our further discussion of the subject will of necessity divide itself on other lines.

While the Table of Contents (page 5) shows the sequence and subjects of the several Parts, a few words of explanation as to the general plan which has been adopted may also be helpful.

PART I. (page 38), which is preceded by a Glossary of the Technical Terms used to designate the component elements of Builders' Hardware, is chiefly "Narrative and Historical," and consists of a series of articles, written by the author, or by others at his instance, descriptive of the development of the industry in the United States; of the principles which underlie the correct designing, selection and use of Art Metal Work; of the origin, growth and facilities of a leading industrial works, one of the largest of its kind in the world, devoted to the production of Builders' Hardware; and, finally, of a historical sketch of the general subject.



PART II. (page 104), relates to the "Mechanics of Hardware," beginning naturally with Locks, which subject is exhaustively discussed in all of its many phases, after which follow briefer explanations of the mechanical characteristics of other articles of Builders' Hardware, intended to promote a better understanding of their kinds and variations, and to assist in the intelligent selection of those best adapted to meet the varying conditions of actual service.

PART III. (page 226) deals chiefly with the subject of "Art-Metal Work and Ornament," for the reason that, as the element of decoration is involved in the greater part of the product under review, it is desirable to have a clear understanding of this phase of the subject before proceeding to the discussion of mechanical details.

The principal feature of this part is a series of original papers prepared, at the author's request, by Mr. W. W. Kent, Architect, on the subject of "The Schools of Ornament," and intended to assist in a better understanding of the origin and characteristics of the various types of accepted ornamentation.

To avoid repetition, and also because believed to be most convenient for practical purposes, each of these papers has appended to it a classified list of available examples of hardware in the School to which it relates, this section thus combining practical or working data with historical and narrative matter.

Sundry short articles are added relative to various phases of Art Metal Work, in order to complete the discussion of this part of the general subject.

This Part also treats of Finishes, that is of the various effects obtained by the use of different metals, by diverse mechanical operations and by chemical manipulation, where-

by a great variety of surface, texture and color is obtained, according to the character of the article or its intended use.

**PART IV.** (page 614). Having thus covered the historical and explanatory portions of the subject, this Part takes up in detail a complete line of "Builders' Locks," and indicates as to each, its size, action, use and approximate price; following which, in Part VI, is similar information concerning a full general line of "Builders' Hardware," these Parts thus constituting, (together with the complementary data in Part III relating to Ornamental Hardware,) a complete working catalogue from which the architect can make selection and frame a specification for the hardware for any building.

**PART V.** (page 680), explains the manner of ordering "Locks in Sets," and illustrates, describes and prices Locks for all purposes complete with Plain and Ornamental trim.

**PART VI.** (page 762), illustrates, describes and prices a line of Plain Hardware.

**PART VII.** (page 822), is devoted to illustrating important Groups of Plain and Ornamental Hardware.

**PART VIII.** (page 962), shows an extensive line of Ornamental Hardware for Cabinet Work.

**PART IX.** (page 994), contains Specifications and Instructions for the ordering of Hardware, and gives explanations on this subject which will be found useful to the Architect and Builder, and conducive to the avoidance of misunderstandings and delays in the execution of orders.

**PART X.** (page 1058), contains "Miscellaneous Information" germane to the general subject.

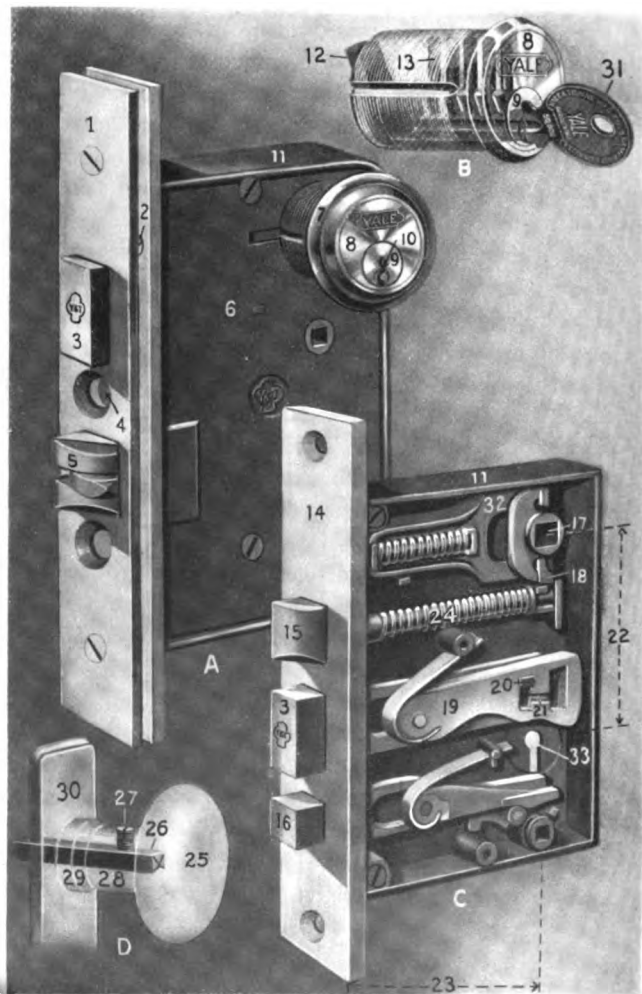

Builders' Locks and their Details.

For definitions see Glossary.

# Glossary

## OF TECHNICAL TERMS RELATING TO LOCKS AND HARDWARE.

---

*Accuracy in Language Promotes Accuracy in Business.*

---

- ADJUSTABLE KEY**—A key for sliding door locks, having a stem or shank adjustable as to its length to adapt the key to doors of various thicknesses. See page 650.
- ANTI-FRICTION AXLE PULLEY**—A sash pulley the axle of which is carried in roller bearings to reduce the friction. See Sash Trim, page 181.
- ANTI-FRICTION BOLT**—A latch-bolt of a lock, when provided with a device for diminishing the sliding friction of the bolt during the closing of the door. See page 10, piece 5.
- APARTMENT HOUSE LETTER BOX**—A box for mail combined with a speaking tube mouth-piece, and an electric push button; used in vestibules of apartment houses. See page 800.
- ARMORED FRONT**—A construction in which the regular front of a cylinder lock is covered by an armor plate, secured to the regular front by machine screws to guard the set-screw which checks the cylinder, and also to protect the front of the lock while the door is being painted, or while the lock is being mortised. This latter result is effected by removing the armor plate from the front of the lock during these mechanical processes. See page 10, piece 1.
- ASTRAGAL**—A molding usually half-round, applied to the abutting edges of a pair of double or folding doors to break and cover the joint. See page 166, Fig. 8, and page 650.
- ASTRAGAL FRONT**—A lock front having a form coinciding in shape with the edges of a door having an astragal molding. See Astragal.
- ASTRAGAL STRIP**—A molding applied to the *surface* of one of a pair of doors, at the edge which abuts against the other door, in order to conceal the joint. See page 166, Fig. 8.
- ASYLUM LOCK**—One for use on doors of insane asylums and especially protected against tampering. See Asylum Locks, page 218.
- AXLE PULLEY**—Synonymous with Frame Pulley, page 20; also see Sash Trim, page 181, Fig. 2.

- BACK FLAP**—Synonymous with Shutter Flap. See Shutter Trim, page 189.
- BACK PLATE**—A plate on the inside of a door and surrounding the orifice leading from a letter drop or plate on front of door. See page 797.
- BACKSET**—(of a lock) —The offset or horizontal distance from the front of a lock to the center line of its knob or key-hole. See page 10, piece 23.
- BALL-BEARING BUTT**—One having a roller or ball bearing to reduce the friction. See Butts, page 173.
- BANK LOCK**—A generic term, covering locks of every kind adapted for use on safes and vaults. Specifically, one for use on burglar-proof safes in contradistinction to those intended only for fire-proof safes. See Bank and Safe Locks, page 220.
- BARN DOOR HANGER**—A sheave mounted in a frame or attachment to the bottom of a sliding barn door, traveling on an overhead rail and carrying the door.
- BARN DOOR LATCH**—A heavy Thumb Latch.
- BARN DOOR PULL**—A large Cupped Pull for heavy doors.
- BARN DOOR ROLLER**—A sheave mounted in a frame for attachment to the bottom of a sliding barn door, traveling on a rail laid in the floor, and carrying the door.
- BARN DOOR STAY**—A small roller, usually carried on a spike or screw, for guiding a sliding barn door.
- BARREL BOLT**—A cylindrical bolt mounted on a plate having a case projecting from its surface to contain and guide the bolt. See Door Bolts, page 179, Fig. 1; also page 763.
- BARREL KEY**—Synonymous with Pipe Key. See Keys, page 139, Fig. 4.
- BAR HANDLE**—A door handle consisting of a bar, usually horizontal, supported by one or more projecting brackets. See page 846, No. 147.
- BELL CRANK**—A bent arm, usually a right angle, turning on a pivot attached to a plate, used for altering the direction of bell wires.
- BELL LEVER**—See Lever Bell Pull, page 24.
- BELL PULL**—A knob, with plate, arranged to pull out longitudinally against the resistance of a spring, its motion being transmitted through wires to a bell. See page 763, No. 1255.
- BEVEL OF LOCK**—A term used to indicate the direction in which the bevel of the latch bolt is inclined; "regular bevel" commonly indicating a lock for use on a door opening inward, and "reverse bevel" one for a door opening outward. See Hand and Bevel of Doors, page 165, Fig. 6.
- BEVEL OF LOCK FRONT**—The angle of the front of a mortise lock when inclined at other than a right angle to the case, to conform to the angle of the edge of the door. See Hand and Bevel of Doors, page 165.

- BEVEL OF DOOR**—The angle of front edge of door. Regular bevel is usually  $\frac{1}{8}$  inch to  $2\frac{1}{4}$  inches. See *Hand and Bevel of Doors*, page 165, Fig. 5.
- BIT** (of a key)—A projecting blade which engages with and actuates either or both the bolt and tumblers of a lock. Synonymous with *Wing*. See *Keys*, page 139.
- BIT-KEY LOCK**—One operated by a key having a *Wing Bit*. See *Lock Primer*, page 105.
- BITTING**—A cut, or indentation, on that part of a key which acts upon and sets the tumblers. See *Lock Primer*, page 105.
- BOLT**—A bar or barrier arranged to secure a door or other moving part, and to prevent its opening. See *Door Bolts*, page 179; also pages 763 to 771.
- BOOKCASE BOLT**—One which automatically fastens or releases one half of a bookcase door when the other half of the door is closed or opened. See *Minor Fastenings*, page 197 Fig. 7, and page 784.
- BOSTON SASH FAST**—A type of *Sash Fast* in which the rotating locking bar is held in the locked position by a trigger or thumb-piece, pressure on which permits the bar automatically to unlock. See page 184, Fig. 12; also page 806, No. 1372.
- BOTTOM BOLT**—One for use on the bottom of a door and having frictional resistance whereby the bolt is prevented from falling into the locked position unless intentionally moved. See *Foot Bolt*, page 764.
- BOX LOCK**—See *Chest Lock*, page 677; also see *Cabinet Locks*, page 216.
- BOX OR SQUARE BOLT**—A square or flat bolt mounted on a plate having a case projecting from its surface to contain and guide the bolt. See *Door Bolts*, page 179, Fig. 2.
- BOX STRIKE**—One in which the aperture to receive the bolt is enclosed or boxed to prevent access from the rear. See *Strike*, page 31.
- BRACKET BEARING**—A knob-thimble or socket which, projecting like a bracket, supports the knob close to its head instead of at the end of the knob shank. See page 10, piece 29, also page 134.
- BUILDERS' LOCK**—One for use in house construction.
- BUTT**—(An abbreviation of the term *Butt Hinge*). A hinge intended for application to the butt or edge of a door, in contradistinction to a flat or strap hinge for application to the surface of the door. See *Butts*, page 173.
- CABINET LOCK**—One for use on cabinet work and furniture. See pages 216 and 674.
- CABIN DOOR HOOK**—A hook and its staple, each with a heavy plate for attaching. Used on shipboard to hold a door at either end of its swing.

- CAM**—A rotating piece whereby the rotary motion of a key or knob imparts reciprocating motion to the bolt of a lock. See page 10, piece 12.
- CANADA BOLT**—A box or other bolt the sliding bar of which is prolonged considerably beyond the back plate and provided with a separate guide near its other end.
- CAP (of Lock)**—The removable part or lid of a lock. Also called "cover." See page 10, piece 6.
- CAPPED BUTT**—One having on each leaf a cap which covers the fastening screws and is itself attached to the butt by one or more smaller screws.
- CARD PLATE**—A plate for use on doors or drawers and arranged to hold a label indicating contents. See Card Frames, page 792.
- CASE (of lock)**—The box containing the bolts and other mechanism. See page 10, piece 11.
- CASEMENT ADJUSTER**—A hinged or pivoted rod for moving and fastening the hinged sash of a casement or French window. See Casement Trim, page 188, Fig. 4, also pages 778 to 781.
- CASEMENT FASTENER**—A catch for fastening a casement or French window. See Casement Trim, page 188, Figs. 5 and 6.
- CASEMENT WINDOW**—One with hinged sashes, opening either in or out. See Casement Window Construction, page 1082.
- CEILING HOOK**—One for use in ceilings, or on the under side of a shelf, and usually having two prongs. See page 795.
- CHAIN BOLT**—One for application at the top of a door, and having a chain depending therefrom, whereby the bolt may be retracted against the resistance of a spring which tends to hold it in the locked position. See page 764.
- CHAIN DOOR FASTENER**—A heavy chain, one end of which is secured to a plate which may be attached to the edge of the door, the other end of the chain carrying a ball or hook, which may be inserted in a slot formed in another plate attached to the jam or other half of the door, whereby the door cannot be opened (except slightly) until the chain is released. See page 782.
- CHAIN PADLOCK**—One provided with a length of chain, whereby the lock may be attached to its staple, or to the adjacent work. See Padlocks, page 215.
- CHANGE KEY**—That key of a master-keyed lock which differs from all others of the same series, and will operate only its own lock (sometimes called room-key). Used in contradistinction to "master-key." See Master-keyed Locks, page 121.

- CITY LOCK**—A nearly obsolete term, used in New York City and vicinity; formerly indicating a superior grade of hand-made locks, but now usually applied to an inferior grade of rim and mortise locks with brass bolts and steel or brass keys.
- CLOSET KNOB**—A single knob on one end of a spindle, on the other end of which latter is a rose or plate to secure the knob and spindle to the door; for use on closet doors. See Knobs and Spindles, page 168.
- COAT AND HAT HOOK**—One with two or more projections, one of which is of sufficient length to receive a hat, the others being usually shorter. See page 794.
- COMBINED ESCUTCHEON PLATE**—One containing both a key-hole and a knob socket. See page 704.
- COMBINATION LOCK**—One having changeable tumblers actuated by a dial on face of door, permanently connected by a spindle with the lock mechanism. See Dial or Combination Locks, page 221, Figs. 2 and 3.
- COMBINATION TUMBLER**—A circular plate of metal, consisting of a central disk, containing the driving pin for communicating motion from one tumbler to the next, and an outer or annular disk, enclosing the central one, and containing the "gating," these two parts being variably adjustable in relation to each other, thus forming the permutation wheel or tumblers of a combination lock. (Also designated as "wheel"). See Dial or Combination Locks, page 221.
- COMBINED STORE DOOR LOCK**—One containing a heavy dead bolt and a latch bolt adapted to be operated by thumb handles instead of knobs. See Store Door Trim, page 159, and pages 664 to 666.
- COMMUNICATING DOOR LOCK**—One for use on doors between communicating rooms; usually a knob latch with thumb bolts. See Locks for Residence Use, page 147, also page 626, No. 1504.
- COMPENSATING HUB**—A lock hub having an elongated spindle-hole to compensate for the shrinking and swelling of a door and to prevent derangement of the lock from these causes. First introduced in the "Vulcan" locks. See page 10, piece 17; also see page 133.
- CONNECTING DOOR LOCK**—Synonymous with Communicating Door Lock. See Locks for Residence Use, page 147; also page 626, No. 1504.
- CORNER PLATE**—One similar to a finger or push plate, but having two arms, forming a right angle, and adapting it for application to the corner of a door. See Hinge, Corner and Kick Plates, page 207; also pages 847 to 872.
- CORRUGATED KEY**—A sheet metal key of uniform thickness and corrugated longitudinally. One having a sinuous cross-section, and not merely grooved on one or both sides. See Keys, page 140, Fig. 5.
- COTTAGE LATCH**—A small Lift Latch for use on cupboards and light doors. See Lift Latch, page 24.



**COVER**—See Cap, page 14.

**CRANK HANDLE**—Synonymous with Lever Handle, page 24.

**CREMORNE BOLT**—A fastening for casement or French windows arranged for application to the surface thereof, consisting of a sliding rod, engaging at top and bottom with strikes or plates in the window frame, and provided near its center with a handle or knob the rotation of which causes the upper and lower parts of the bolt to move in opposite directions in locking or unlocking, and sometimes provided with an additional horizontal bolt, also operating simultaneously, which serves further to secure the sash at or near its center. See Casement Trim, page 186, Fig. 2 ; also page 887.

**CUPBOARD BUTTON**—A small turning bar, adapted to secure a door. See Minor Fastenings, page 196, Fig. 3.

**CUP ESCUTCHEON**—A door plate, for use on sliding doors, having a recessed panel to afford finger-hold and to contain the knob, or its equivalent, and a key, all of the contained parts being flush with the surface of the plate in order to offer no obstruction to the movement of the door within its recess. See pages 706 and 904 to 915.

**CUPBOARD CATCH**—A small spring catch adapted for fastening a light door, and operated by a slide knob or thumb-piece. See page 196, Fig. 2 ; also page 782.

**CUPBOARD LOCK**—One designed for use on doors of cupboards, boxes, etc. See page 674, No. PA74.

**CUPBOARD TURN**—A small spring catch adapted for fastening a light door and operated by a rotating knob or handle. See Minor Fastenings, page 196, Fig. 1 ; also page 785.

**CYCLOID KNOB ACTION**—An arrangement of intergeared pivotal levers for transmitting motion from a lock hub to the latch bolt. First introduced in the "Vulcan Locks." See page 131, Figs. 6, 7 and 8.

**CYLINDER (of a lock)**—A short cylindrical case containing the key-hole and tumbler mechanism of a lock of the "Yale" type. Formerly called "Escutcheon." See page 10, Fig. B ; also The Yale Lock page 71.

**CYLINDER LOCK**—One in which the key-hole and tumbler mechanism are contained in a cylinder or escutcheon separate from the lock case, as in the Yale Lock, the original lock of this type. See page 10, Fig. A ; also Cylinder and Pin-tumbler Locks, page 137.

**CYLINDER RING**—A rose, or washer, placed under the head of a cylinder (of the Yale type) to enable a long cylinder to be used on thin doors. Also called Rose. See page 10, piece 7.

- CYLINDER SCREW**—The set-screw in the face of a Yale mortise lock for preventing the unscrewing of the cylinder. See page 10, piece 2. (Also called set-screw).
- DEAD BOLT** (of a lock)—One having a square head, and moved positively by the key in both directions. See page 10, piece 3.
- DEAD LATCH**—Synonymous with Night Latch, page 25. See page 615, No 42.
- DEAD LOCK**—One having a dead bolt only. See page 617, No. 702.
- DESK LOCK**—One adapted to secure the rolling or hinged lid of a desk. See page 678, No. S250, and page 676, No. S230
- DETACHABLE KEY**—One so constructed that the bits, or portion which actuates the tumblers, may be detached from the shank or handle of the key for convenience in carrying. Formerly much used with bank locks requiring large and heavy keys.
- DIAL LOCK**—Synonymous with combination lock, and now more generally used. See Dial or Combination Locks, page 221.
- DIRECTION PLATE**—One giving information concerning the purpose of the door or opening on which it is used. See Signs, page 811.
- DOOR BOLT**—A sliding rod or bar, suitably mounted for attachment to a door and adapted to secure it. See pages 179 and 763.
- DOOR CHECK**—A device for preventing the slamming of doors provided with springs. Frequently used as synonymous with "Door Check and Spring." See pages 201 and 787.
- DOOR CHECK AND SPRING**—A device combining, in one structure, a door spring and a check to prevent slamming of the door. See pages 201 and 787.
- DOOR HOLDER**—A device for fastening a door in an open position. See page 206, Figs. 7 to 10, and Door Stops, pages 789 and 790.
- DOOR PULL**—A bent handle usually mounted on a plate, and adapted for attachment to the surface of a door. See pages 823 to 846.
- DOOR STOP**—A device to limit the swing, or movement of a door when open. See page 206, Figs. 7 to 10, and pages 789 and 790.
- DOUBLE-ACTING BUTT**—One which permits a door to swing in both directions. See Double-acting Hinges, page 199.
- DOUBLE-ACTING SPRING HINGE**—One having a double set of Springs opposed to each other, and each tending to move the door into the closed position, the hinges being so constructed as to permit the door to swing in either direction. See page 199.

- DOUBLE-BITTED KEY**—One having bittings on both sides, whereby either or both wings or sides of the key may actuate the tumblers. See page 140, Figs. 9 and 10.
- DOUBLE DOOR BOLT**—One having two sliding bars, moving in opposite directions, to secure a door simultaneously at the top and bottom. See Casement Trim, page 185; also pages 766 to 768, and page 887.
- DOUBLE HUNG WINDOW**—One with two vertically sliding sashes.
- DRAWER KNOB**—A small knob suitable for use on drawers and cabinet work. See Metal Knobs, pages 940 to 943, and Glass Knobs, pages 947 to 951.
- DRAWER LOCK**—One adapted for use on drawers. (Also known as a Till Lock.) See page 675.
- DRAWER PULL**—A handle or grip adapted to receive the fingers. See pages 925 to 939.
- DRILL PIN**—A round pin projecting from the back plate of a lock and fitting into a hole in the end of the key. See page 674, Lock PA74.
- DROP ESCUTCHEON**—An escutcheon or key-plate provided with a pivoted drop covering the key-hole. See page 958, Figs. 50 and 58.
- DROP DRAWER PULL**—A pull or handle pivoted at its ends to its attaching plate. See pages 929 to 936.
- DROP HOOK**—Synonymous with Shutter Bar. See pages 189, Fig. 3, and pages 812 and 922.
- DROP KEY**—One having a bow, or handle, pivoted to the shank, so that it may drop or fall parallel with the surface of the door. See pages 650 and 651.
- DROP KEY PLATE**—One having a swinging cover, or drop, to protect the key-hole. See page 958, Figs. 50 and 58.
- DRUGGIST'S DRAWER PULL**—A drawer pull combined with a plate to contain a label. See page 939, Figs. 125 and 126.
- DUMB WAITER PULLEY**—A heavy Axle Pulley for use with dumb waiters.
- DUPLEX LOCK**—A master-key lock of the cylinder type, such as the Yale Lock, provided with two cylinders on the same side, both acting on the same bolt, but each controlled by a different key, whereby, when used in a series, one of said cylinders, may be operated by the master-key which passes every lock in the series, and the other by a change key, which may be different for each lock throughout the series. See pages 667 to 669.
- DUTCH DOOR BOLT**—One for locking together the upper and lower halves of a Dutch Door. See Dutch Door Trim, page 145.

- EASY SPRING**—A term used to designate the construction of a knob lock in which two springs are employed, one of which (the easy spring) acts only on the latch bolt, while the other acts directly or indirectly on the knob spindle. Motion of the latch bolt is opposed by the easy spring, while both the springs give resistance to rotation of the knobs, thus giving a lively action to the knobs while permitting the door to close easily. The same action may also be obtained with a single spring if suitably connected with the related parts of the lock. See page 10, piece 24.
- ELBOW CATCH**—A pivoted fastening for cupboard doors, one end having a hook to engage with a strike or staple and the other end bent to a right angle to form a handle for releasing the catch. See page 197, Fig. 6; also page 784.
- ELEVATOR LATCH**—A bolt consisting of a pivoted arm carried by a plate on a door and engaging with a strike or hook on the jamb. See page 648, No. P1902½.
- ELEVATOR LOCK**—One for use on doors of elevator shafts; usually operated by a key from outside and by a flush lever handle from the inside. See page 648, No. 1792.
- ESCUTCHEON**—Generically a plate containing a key hole. See page 10, piece 30; also page 704.
- ESCUTCHEON KNOB**—A door knob containing a key escutcheon, the latter actuating the lock or controlling the rotation of the knob. (Used chiefly with Asylum Locks.) See page 218.
- ESCUTCHEON PLATE**—A plate, whether plain or ornamental, either with or without key-hole opening, containing a knob socket, and adapted for attachment to the surface of a door. Page 10, piece 30, also page 704.
- ESPAÑOLETTE BOLT (or Bar)**—A fastening for casement of French windows, arranged for application to the surface thereof, consisting of a rotating rod extending from top to bottom, with hooks at each end which engage with pins or plates in the window frame when the bar is rotated, and having a hinged handle near the center whereby the bar may be rotated to fasten or release the sash and which also engages with a strike or keeper which holds the bar in the locked position and further secures the sash near its center. See Casement Trim page 187, Fig. 3; also page 887.
- EXTENSION BOLT**—A flush bolt having a short plate to receive a knob or thumb piece, which latter is connected at the bolt end at top or bottom of door by an extension rod inserted through a hole bored in thickness of door. See Door Bolts, page 179; also pages 765 to 768.
- EXTENSION KEY**—Synonymous with Adjustable Key, page 11.
- FAN LIGHT**—A semi-circular transom light, (improperly used as synonymous with transom light). See Transom Trim, page 195.

- FAST JOINT BUTT**—One in which the hinge pin is riveted, or otherwise secured, and the two parts of the butt permanently fastened together. See Butts, page 173; also pages 774 to 775.
- FENCE**—A projecting portion of a lock, usually attached to the bolt, which engages with the tumblers, and enters or passes through the "gating" of the tumblers when the bolt is retracted. See page 10, piece 20.
- FINGER PLATE**—A plate for attachment to a door to prevent soiling of its surface by handling. Synonymous with Push Plate. See pages 802 and 923.
- FIRE-PROOF SAFE LOCK**—A bank lock, for use on safes proof against fire, but not against burglars, the chief difference being in the construction of the lock spindle to resist attack. See Bank and Safe Locks, page 220.
- FLAT KEY**—A thin flat key, made of sheet or plate metal, usually by stamping. Sometimes provided with longitudinal grooves or indentations on one or both sides. See Keys, page 139.
- FLOOR HINGE**—A pivot door hinge, arranged to be set in the floor, and usually combining with the hinge a door spring and frequently also a door check. See Double Acting Hinges, page 200, Fig 2.
- FOLDING KEY**—One having a handle and a blade or shank, hinged together, the blade folding into the handle like a jack knife.
- FLUSH BOLT**—A door bolt mounted behind a plate adapted to be attached to and let into the surface of a door. See Door Bolts, page 179, also pages 769 and 770.
- FLUSH CUPBOARD CATCH**—One which is half mortise, i. e., let in flush with face of door. See Minor Fastenings, page 196, Fig. 2.
- FLUSH PLATE**—A door plate of any kind intended to be let into the wood flush with its surface.
- FLUSH RING**—A flush drawer handle of circular form. See page 939, Figs 121 and 124.
- FLUSH RING CUPBOARD CATCH**—One with a flush ring in place of a knob for actuating the bolt. See page 782, No. 1481.
- FOOT BOLT**—A spring bolt for the bottom of a door which, when retracted, is retained by a trigger, the release of which latter permits the spring to shoot the bolt into the locked position. See page 764.
- FRAME PULLEY**—A box containing a sheave, and adapted to be mortised into a window frame for carrying the sash cord. See page 181, Fig. 2; also page 791.
- FRENCH ESCUTCHEON**—A small circular key-plate containing a key-hole secured by driving or screwing into the wood.

- FRENCH HARDWARE**—A term used to designate rim locks and bolts of ornamental character, as used in French construction. See pages 583 to 594.
- FRENCH WINDOW**—One mounted on hinges like a door; a casement window extending to the floor. See Casement Window Construction, page 1082.
- FRENCH WINDOW LOCK**—A mortise knob lock with small backset, for use on French windows or doors with narrow stiles. See pages 632 and 633, Nos. 1640 to 1645.
- FRONT (of lock)**—The face plate of mortise lock through which the ends of the bolts are projected. See page 10, piece 14.
- FRONT DOOR LOCK**—A lock for use on entrance doors, having a dead-bolt and a latch-bolt; the former controlled from the outside by a key and from the inside by a key or knob; the latter controlled from the outside by a key and from the inside by a knob. Usually provided with "stop work" whereby the outside knob may be set to actuate the latch-bolt or not, as desired. See page 10, Fig. A, also page 142.
- GATING**—The opening in the tumbler of a lock into or through which the "fence" passes to release the bolt or permit of its movement. See page 10, piece 21.
- GRILLE**—An ornamental screen of open metal work, wrought or cast. See page 163 showing Grille on Door.
- GUARDED FRONT AND STRIKE**—A construction of these parts of a lock such that they may interlock, so as to protect the latch-bolt from attack through the crevice between the door and jamb. Chiefly used in Insane Asylums. See pages 672 and 673.
- GUARD LOCK**—One which guards or checks another lock; especially that part of the mechanism of a safe deposit lock which is controlled by the attendant's key, and which checks or guards the other part of the mechanism controlled by the renter's key. Also applied to a separate lock adapted to guard or cover the key-hole. See page 222.
- HAND (of locks, etc.)**—A term indicating whether the article is adaptable to either a right hand or left hand door. See Handle and Bevel of Doors, page 165.
- HANDED**—A term indicating that the article is adaptable to either a right or a left hand door, but not both.
- HANGING STILE**—That stile of a door to which the hinges are attached by which the door is hung.
- HALF-RABBETED LOCK**—A mortise lock, the front of which is turned into two planes, at right angles, thus adapting it to use on a door with rebate on edge. One having a front in two planes forming a single right angle.

- HASP LOCK**—A prison lock permanently attached to the hasp of the door, and adapted to secure the same when in a closed position.
- HINGE**—A pair of jointed plates, attached respectively to a door and its frame, whereby the door is supported and is enabled to swing or move. See Butts, page 173 and pages 772 to 777 and 918 and 919.
- HINGE PLATE**—Synonymous with Hinge Strap.
- HINGE STRAP**—A plate, usually ornamental, adapted for attachment to the surface of a door, fitting at one end against the knuckle of a butt, and intending to give the effect of a strap hinge. See pages 847 to 866.
- HORIZONTAL LOCK**—One whose major dimension is horizontal. See page 626, No. 1404.
- HOT HOUSE PULLEY**—A *rim* axle pulley; mounted in a projecting frame or box and intended to be applied to the surface of a window frame or wall instead of being mortised therein.
- HOTEL LOCK**—A master-keyed knob lock. See pages 151 and 641 to 644; also pages 699 and 727.
- HUB**—A rotating piece within a lock, containing a central aperture to receive the knob spindle and engaging with the bolt or tail piece in the lock whereby the motion of the knob is communicated to the bolt. See page 10, piece 17.
- INSIDE DOOR LOCK**—Synonymous with Room Door Lock, page 28.
- INSTANT LOCKER**—A term applied to a time lock constructed to lock automatically, by spring action, upon the closing of the door.
- JAMB LOCK**—A prison lock designed to be built into the masonry of the door jamb, the bolt when locked being projected from the jamb and engaging with the door. See Prison Locks, page 219.
- JAM JOINT**—A joint used on the abutting of edges of French sashes, in which the edge of one sash is convex and of the other concave to a radius equal to one-half the thickness of the sash, the purpose being to form a weather tight joint. See Casement Window Construction, page 1082.
- JANUS-FACE LOCK**—A rim lock both sides of which are similarly molded or ornamented, so that either side may be applied to the door, thus making the lock both right and left hand.
- KEY-CHANGING LOCK**—A lock actuated by a key, the bits and combination of which are changeable at pleasure.
- KEY HOLE**—The opening in a lock, or the door to which it is fitted, for the insertion of the key. See page 10, piece 33.
- KEY-PLATE**—The plate, either plain or ornamental, having one or more key-holes (but no knob socket), and adapted for attachment to the surface of a door. See pages 952 to 960.

- KEY-WAY**—The aperture, in locks of the Yale type, which receives the key and engages closely with it throughout its length, as distinguished from the open *key-hole* of a common lock. See page 10, piece 10.
- KICK PLATE**—A plate for protecting the surface of a door, and adapted to be applied at or near its bottom. See pages 801 and 870.
- KNEE BUTT**—Synonymous with Pocket Butt. See page 773, No. 60.
- KNOB**—A projecting handle, usually round or spherical, for operating a lock. See page 10, piece 25.
- KNOB BOLT**—A door lock, the bolt of which is controlled by a knob or thumb piece from either or both sides of the door, (not one actuated by a key). See page 631, No. P2205.
- KNOB LATCH**—A door lock having a spring bolt operated from either or both sides of the door by a knob (not one actuated by a key) See page 622, No. P2200.
- KNOB LOCK**—A door lock having both a spring bolt, operated by a knob, and a dead bolt, operated by a key; (a knob lock thus combines in one structure a knob latch and lock). See page 637, No. 1420.
- KNOB ROSE**—A round plate, or washer, forming a knob socket, and adapted for attachment to the surface of a door. See Knobs and Spindles, page 168, also pages 708 and 709.
- KNOB-SHANK**—The projecting stem of a knob, containing the hole or socket to receive the spindle. See page 10, piece 28.
- KNOB-TOP**—The upper and larger part of a knob, that which is grasped by the hand; usually made of porcelain, glass or wood, or, in the better class of knobs, of metal. See page 10, piece 25.
- KNUCKLE**—The enlarged part of a hinge or butt which receives and encloses the hinge pin. See Butts, page 173.
- LATCH**—A lock, the bolt of which is beveled and is self-acting by the pressure of a spring or by gravity. See page 615, No. 42.
- LATCH-BOLT (of a lock)**—One having a beveled head, and actuated by a spring, whereby it is retracted by impinging against the strike, and is automatically thrown forward again by the spring. See page 10, piece 15.
- LETTER BOX BACK**—Synonymous with Letter Box Hood. See page 917, Figs. 2, 4, 6, 8, etc.
- LETTER BOX CHUTE**—A lining for the opening through a door behind a letter hole plate; usually inclined downward; sometimes combined with a hood or back-plate on rear of door.
- LETTER BOX HOOD**—A plate for attachment to the rear of a door to conceal the opening through the door from a letter plate and to direct letters downward. See page 917, Figs. 2, 4, 6, 8, etc.



- LETTER DROP PLATE**—One containing an opening, usually closed by a drop or flap, to permit the passing of letters. See pages 797 and 917.
- LEVER**—An abbreviation of the term "Lever Tumbler" (see below), and inaccurately used as synonymous with Tumbler. See page 10, piece 19 and Lock Primer, page 105. Fig. 4.
- LEVER BELL PULL**—One actuated by lever action in place of by drawing out of knob. See Bell Pull, page 12.
- LEVER CUPBOARD CATCH**—One consisting of a lever pivoted on a plate, through which it passes, its inner end having a hooked form to engage with a staple, and its outer end formed into a knob or handle. See Minor Fastenings, page 198, Fig. 12.
- LEVER HANDLE**—A bent handle for actuating the bolt of a lock and used in the place of a knob. See page 1074; also pages 793, 878 and 879.
- LEVER TUMBLER**—A lock tumbler having a pivotal action. See Tumbler, page 32A; also page 10, piece 19, and page 105, Fig. 4.
- LIFT LATCH**—An unencased rim latch consisting of a bar pivoted to a plate and engaging with a hook on the jamb, the bar being operated by thumb-piece on the outside of the door and by a lift handle on the inside; usually combined with a door pull on one or both sides of the door. See page 742, Fig. 29.
- LOCK**—Generically, a fastening of any kind operated by a key. Specifically, one having a dead bolt, as distinguished from one having a spring latch-bolt. See Lock Primer page 105, also page 10, Figs. A and C.
- LOCK RAIL** (of a door)—A rail located at the proper height to receive the lock, and usually made broader for that purpose.
- LOCK-SET**—A lock combined with its trim, i. e., complete with knobs, escutcheon plates and screws. See Lock Trim and Lock-sets, page 161, also Locks in Sets, page 680.
- LOCKER RING**—A pull, for mortising into the edge of a sliding locker door, consisting of a plate containing a ring which may be pushed back flush with the plate or pulled forward for use as a pull to open the door.
- LOOSE JOINT BUTT**—One having a single knuckle on each half, one of them containing the pin and the other a corresponding hole, whereby the two parts of the butt can easily be separated. See Butts, page 173, also page 774.
- LOOSE PIN BUTT**—One having a hinge pin which can be withdrawn to permit the two parts of the butt to be separated. See Butts, page 173, also pages 776 and 919.
- MASTER-KEY**—(sometimes called pass-key)—The key pertaining to a series of master-key locks which will actuate any and all of the locks. See Master-Keyed Locks, page 121.

- MASTER-KEYED LOCK**—One intended for use in a series, each lock of which may be actuated by two different keys, one capable of operating every lock of the series, and the other capable of operating only one or a few of the locks. See page 121.
- MEETING RAIL**—The horizontal rail of a sliding sash which meets with the corresponding rail of the other sash to form a joint between the two sashes when closed. See page 184, Fig. 10.
- MORTISE BOLT**—A door bolt designed to be mortised into a door, instead of being applied to its surface. See *Minor Fastenings*, page 197, Fig. 9; also pages 631 and 632.
- MORTISE LOCK OR LATCH**—One designed to be mortised into the edge of a door; not applied to its surface. See page 10, Figs. A and C.
- NAME PLATE**—One containing a name, as for front door use; also applied to a plate containing the name, address and business of the maker of a machine or other article to which the plate is attached. See *Signs*, page 811.
- NECKED BOLT**—A bolt the projecting end of which has a bend or offset to engage with a strike or keeper not in line with the body of the bolt. See page 763, No. 290.
- NIGHT KEY**—That one of the two keys of a front door lock which controls the night work and operates the latch-bolt. See *Front Door Lock*, page 142.
- NIGHT LATCH**—A door lock having a spring-bolt which cannot be operated from the outside except by a key. See page 615, No. 42.
- NIGHT WORK**—A term used to indicate that part of the mechanism of a front door or vestibule lock which controls the latch-bolt, and is actuated by the night key. See *Front Door Lock*, page 142.
- NOSE PLATE**—A small plate surrounding the nose or escutcheon of a cylinder lock. See page 676, No. S230.
- OFFICE LOCK**—An arbitrary term applied to a knob lock (which see) of *inverted* form, i. e., with key-hole above knob, and especially designed for use on office doors. See pages 156 and 645 to 647.
- PADLOCK**—A detachable lock, with a shackle or link, adapted to engage with a staple. See page 215.
- PARACENTRIC**—An arbitrary term adopted by the makers of the YALE LOCK to designate a peculiar form of key and key-way, the cross section of which shows ribs projecting from opposite sides of the key-way *past its center line*, and extending longitudinally throughout its length, thereby preventing the use of picking tools; the opposite sides of the key being grooved to correspond with the contour of the key-way, and the key and key-way thus being interlocked throughout their length. See page 10, piece 31; also *The Yale Lock*, page 71.

- PARLIAMENT BUTT**—One having T-headed leaves, usually broad. See page 774, No. 260.
- PASQUIL LOCK**—One for the rolling or sliding tops of desks, which resembles a horizontal Cremorne bolt, in having two sliding bolts, moving in contrary directions, and engaging at each end of the lid or top with the frame of the desk, and controlled by a locking mechanism in the centre. See page 678, No. S250.
- PERMUTATION LOCK**—A term formally applied to a lock having changeable tumblers, whether actuated by a key or by a dial. See Dial Locks, page 221, Figs. 2 and 3.
- PIN TUMBLER**—A small sliding pin actuated by the key, and dogging the plug or key-hub, by which motion is transmitted to the bolt, as, for example, in a Yale Lock. See page 10, piece 13; also The Yale Lock, page 71.
- PIPE KEY**—A round key having a hole drilled into its end to fit over a drill pin in the lock. Used chiefly for cabinet locks. Synonymous with Barrel Key. See Keys, page 139, Fig. 4; also pages 106, Fig. 6, and 674, No. PA74.
- PLATE ESCUTCHEON**—Synonymous with Key Plate. See pages 952 to 960.
- PLUG (of a lock)**—A cylindrical piece containing the key-hole and rotated by the key to transmit motion to the bolt. See page 10, piece 9; also The Yale Lock, page 71.
- POCKET BUTT**—A hinge or butt, for three-ply inside shutters, each leaf of the butt being bent at a right angle near its center; for use on the third leaf of the shutter to permit the latter to enter and leave its *pocket* without jamming. See page 773, No. 60.
- PRISON LOCK**—One designed for use on cell doors, and operated by the key from one side only. See page 219.
- PULL DOWN HANDLE**—A light handle for attachment to the under side of the bottom rail of upper sashes for use in moving the latter. See Sash Trim, page 182, Fig. 7.
- PULL DOWN HOOK**—Synonymous with Sash Hook. See page 804, No. 1359.
- PUSH BUTTON**—A small movable knob or button, within a socket, the movement of which actuates a bell, electrically or otherwise. See pages 895 to 903.
- PUSH BUTTON SWITCH**—A switch for controlling electric lights operated by two push buttons, one of which when pushed in makes, and the other breaks, the circuit. See Switch Plates, page 920.

- PUSH (or thrust) KEY**—One which performs its whole function of setting the tumblers by longitudinal motion without rotation.
- PUSH PLATE**—A plate for protecting the surface of a door against soiling and wear from handling. Frequently made with the word "Push" incorporated in the design. See pages 802 and 923.
- RABBETED LOCK**—A mortise lock, the front of which is formed with an offset or rebate conforming to the corresponding rebate on edge of door. One having a front in three planes, forming two right angles. See page 165; also page 659, No. 726R.
- RAIL (of a door)**—Any of the horizontal members which enclose the panels and which, with the stiles, constitute the frame work.
- REACH (of a Transom Lift)**—The distance from center of operating rod to the nearest edge of the transom sash. See Transom Trim, page 193 and 813.
- REBATE (also spelled Rabbet)**—The offset on the abutting edges of a pair of double doors. Also the corresponding offsets on the fronts and strikes of rabbeted locks. See page 166, Fig. 7; also page 659, No. 726R.
- RECESS (of a Transom Lift)**—The distance inward from the face of the door casing to the face of the transom sash. See Transom Trim, pages 193 and 813.
- REFRIGERATOR HINGE**—A surface hinge, usually of ornamental outline.
- REVERSE BEVEL (of latch bolt)**—A term used to indicate that the bevel of a latch-bolt (page 10, piece 15) is reversed, or inclined in the opposite direction to that which is regular. See Hand and Bevel of Doors, page 165.
- REVERSED**—A term applied to articles made of wrought or sheet metal with edges turned back to give the appearance of increased thickness. See W7000 Escutcheon Plates, page 705. For illustrations see page 704, Figs. 3 and 4.
- REVERSED DOOR**—One opening in the opposite direction to that which is usual or regular. Room doors if opening inward are "regular," if opening outward are "reversed." Cupboard doors are regular if opening outward. See Hand and Bevel of Doors, page 163.
- REVERSIBLE LOCK**—One in which the latch-bolt can be reversed to adapt the lock to a door of either hand. See page 167, and for construction of latch bolt see page 10, piece 15.
- RIM**—A term applied to articles of hardware intended to be applied to the surface of doors, windows, etc., in contradistinction to those intended to be mortised into the wood.

- RIM LOCK OR LATCH**—One which is applied to the surface of the door, not mortised into it. See example of Rim Lock page 615, No. 42.
- ROLL BACK**—A rotating piece within a lock, permanently attached to the knob-spindle, for transmitting motion to the bolt. Inaccurately used as synonymous with hub.
- ROOM DOOR LOCK**—A knob lock for doors leading from halls or corridors into rooms. Also called Inside Door Lock.
- ROSE**—A circular, square, or oblong plate for attachment to a door and containing a socket for supporting and guiding the shank of a knob. See page 168; also pages 702 and 703.
- ROUND KEY**—One having a round shank or stem. See Keys, page 139.
- SAFE DEPOSIT LOCK**—One for use on the iron doors of safe deposit boxes. See Bank and Safe Locks, page 220.
- SAFETY DOOR HOLDERS**—Synonymous with Door Holder, page 17.
- SASH ADJUSTER**—A swinging arm for adjusting and securing swinging sashes in any desired position. See Casement Trim, page 188, Fig. 4; also pages 778 to 781.
- SASH CENTER**—A pin or bearing for a transom light or other sash turning on a horizontal axis, consisting usually of a pair of plates, one carrying a pin and the other a socket, one plate intended for attachment to the sash and the other to the jamb or frame in which the sash is hung. See Transom Trim, page 194, Figs. 8 and 9; also page 805.
- SASH CHAIN**—A metal chain adapted for use with sliding sashes in place of a cord or rope.
- SASH CORD**—A small cord or rope used to connect a sliding sash with its counterweight.
- SASH CORD IRON**—A small casting inserted in the edge of a sliding sash to secure the end of the sash cord or chain.
- SASH FAST**—A fastening usually attached to the meeting rail of sashes, to prevent their being opened until released. See Sash Trim, page 183, Figs. 9, 10, 11, 12, also page 806.
- SASH HOOK**—A metal hook usually attached to one end of a wooden rod, and adapted to engage with a hole or socket in the upper sash, whereby the latter may be raised or lowered. See Sash Trim, page 183, Fig. 8; also page 804.
- SASH LIFT**—A plate, bar or hook, adapted for attachment to a window sash, whereby the latter may be conveniently raised and lowered. See Sash Trim, page 182, Figs. 4, 5, 6; also pages 806 to 808 and 916.
- SASH LIFT AND LOCK**—A sash lift provided with a locking lever, which locks the sash by engaging with a strike in the window frame and is released in the act of raising the sash. See page 808, No. 1349L.

- SASH LOCK**—A fastening controlled by a key, and adapted to secure a sash. See page 809, Nos. 910, 912 and 914.
- SASH PIN**—A form of window spring-bolt See page 809, No. 915.
- SASH PLATE**—Synonymous with Sash Center. See Transom Trim, page 194, Figs. 8 and 9; also page 805.
- SASH PULL**—A handle for attachment to the under side of the lower rail of an upper sash of a double-hung window, for pulling down the sash. (Also called Window Pull and Pull Down Handle). See Sash Trim, page 182, Fig. 7.
- SASH PULLEY**—Synonymous with Frame Pulley, page 20.
- SASH RIBBON**—A thin metal band adapted for use with sliding sashes in place of cord or rope.
- SASH SOCKET**—A metal plate containing a hole or cup adapted to receive a sash hook. See Sash Trim, page 183, Fig. 8; also page 804.
- SASH WEIGHT**—A weight used to balance sliding sashes usually of cast iron and of long cylindrical form. See Weights of Sashes and Glass, page 1088.
- SCREEN DOOR CATCH**—A light knob-latch, similar to a cupboard turn but furnished with a hub, a spindle, and a pair of knobs or lever handles. See page 783, No. 530.
- SCREWLESS KNOB**—A term originally applied to knobs provided with a clamp or vice for attaching them to the spindle and thus dispensing with the old-fashioned "side screw." Now used also to designate any knob which eliminates the "side screw" and substitutes a fastening which obviates all tendency to become loose, even though employing a set-screw, as, for example, in the case of the Triplex Spindle. See page 10, Fig. D; also Knobs and Spindles, page 171, Fig. 2.
- SECRET LATCH**—One operated by a concealed button or other device; for use on office gates, etc. See page 616, No. 4305.
- SET-SCREW**—One which by checking another screw, or other movable part, prevents it from loosening. See page 10, piece 27.
- SHACKLE (of padlock)**—A swinging or sliding link, usually curved, adapted to engage with a staple and to be fastened by the locking mechanism of the padlock. See Padlocks, page 215.
- SHANK (of a key)**—That part which connects the bit or wing with the bow or handle. See Keys, page 139.
- SHANK (of a knob)**—That part which contains the hole or socket to receive the spindle and which forms a base for the top or enlarged portion of the knob. See page 10, piece 28.

- SHELF PIN**—A metal pin for supporting a book shelf; called also Shelf Support or Shelf Rest.
- SHELL (of padlock)**—The case or body of a padlock, which contains the mechanism. See Padlocks, page 215.
- SHIP LOCK**—One wholly of brass for use on ships; usually of heavy construction. See page 621, Nos. 1770 and 1783.
- SHUTTER ADJUSTER**—A swinging arm for adjusting and securing shutters in any desired position. See Shutter Trim, pages 190 and 191.
- SHUTTER BAR**—A fastening for folding blinds consisting of a bar pivoted to a plate and engaging with a hook or stud attached by another plate to the other half of the blind. See page 189, Fig. 2; also pages 812 and 922.
- SHUTTER BUTT**—A small hinge, usually narrow, adapted for use on shutters and light doors. See Shutter Trim, page 189; also pages 772 and 922.
- SHUTTER FLAP**—A small hinge, usually broad, intended to be screwed to the surface of the shutter or small door. See Shutter Trim, page 189, also pages 773 and 922.
- SHUTTER KNOB**—A small knob for inside shutters. See Shutter Trim, pages 190 and 796 and pages 940 to 943.
- SHUTTER LIFT**—A lift for shutters; similar to a sash lift (but heavier). See Sash Lift, page 28.
- SHUTTER SCREW**—A heavy thumb-screw for securing one end of a vertical shutter.
- SIDE-SCREW**—A small screw used for securing a common knob to its spindle. See Knobs and Spindles, page 168.
- SLIDER**—A small sliding tumbler actuated by the key, and dogging the plug by which motion is transmitted to the bolt, as, for example, in Bramah lock.
- SLIDING DOOR KEY**—One adapted for use with a mortise lock and a cup escutcheon on sliding doors; usually adjustable as to length. See page 650.
- SLIDING DOOR LOCK**—A lock for use on a door which slides, and having hook-shaped bolts to engage with its strike. See pages 650 and 651.
- SLIDING DOOR PULL**—A plate or box, arranged to be mortised into the edge of a sliding door and containing a handle, or pull, for use in moving the door from its recess. See page 789, Nos. 58 and 68.
- SLIDING DOOR RAIL**—A metallic rail for carrying and guiding the sheaves of sliding doors.

- SLIDING DOOR STOP**—A small plate for attachment to floor or ceiling and provided with a stump or projection to limit the motion of a sliding door. See page 789, Nos. 900 and 901.
- SLIDING TUMBLER**—A lock tumbler having a sliding motion. See Tumbler, page 32B.
- SOCKET**—See Thimble, page 32.
- SOLID ROLLED**—A term used to designate Escutcheon Plates and other articles made from rolled, or wrought metal of sufficient thickness to show a suitable bevel without turning back the edges (as is done in "reversed" work). See W6000 Escutcheon Plates, page 705. For illustrations see page 704, Figs. 1 and 2.
- SPACING**—The distance between the center of a knob-hub and the center of a key-hole of a lock or its escutcheon plate. See page 10, Fig. 22.
- SPINDLE (of lock)**—The axis or shaft, usually of square section, which carries the knobs of a lock, and communicates their motion to the latch mechanism. See page 10, piece 26; also Knobs and Spindles, page 170.
- SPRING HINGE**—A hinge or butt containing one or more springs acting to move the door into the closed position. See Double-acting Hinges, page 199.
- SQUARE BOLT**—A rim bolt of rectangular section. See page 763, No. 294.
- STAPLE (of padlock)**—A metallic loop, or eye, for receiving the shackle of a padlock, and adapted to be driven into, or otherwise attached to, a door or jamb. See Padlocks, page 215.
- STEM (of a key)**—The round portion of the bit or wing which forms the trunnion or axis of the key, and on which it rotates when in the lock. See Keys, page 139.
- STILE (of a door)**—Any of the vertical members which enclose the panels and with the rail constitute the frame work.
- STOP (of a lock)**—That which serves to fasten the bolt or the knob in the locked or unlocked position, usually the latter. See page 10, piece 4.
- STOP BEAD SCREW**—Synonymous with Stop Screw.
- STOP KEY**—One for insertion in a key hole from one side to prevent the entrance of a key from the opposite side.
- STOP SCREW**—A screw for fastening the stop bead of a window to the frame. See Sash Trim, page 182, Fig. 3.
- STOP WORK**—See Stop (of a lock).
- STORE DOOR HANDLE**—A bent handle, usually mounted on a plate, provided with a lever or thumb handle for actuating a latch bolt, and adapted to be applied to the surface of a door. See pages 738 to 760.
- STORE DOOR LATCH**—One containing a spring latch bolt only, and adapted to be operated by thumb handles. See page 664, No. 1122.



- STORE DOOR LOCK**—A heavy lock containing a dead bolt only, and usually operated by a key from both sides. See page 618, No. 12.
- STRAP HINGE**—A hinge, of which one (or both) of the leaves has considerable length, and is adapted for attachment to the surface of a door. See pages 847 to 866.
- STRIKE**—A metal fastening, on the door frame, into which the bolt of a lock is projected to secure the door. Applied both to the flat plate used with mortise locks, and to the projecting box used with rim locks. Synonymous with "striker," "striking plate" and "keeper."
- STUMP**—A small piece or projection in a lock for the engagement of one part with another, or to receive a screw or rivet. Also, but inaccurately, used as synonymous with "Fence." See page 106, Fig. 9.
- SUB-MASTER KEY**—One capable of controlling a subordinate group of master-key locks, each having a different key of its own, but all in turn controlled by the main or grand master-key. (There may thus be a number of sub-master keys under one grand master-key.) See *Master-Keyed Locks*, page 121.
- SUBSEQUENT LOCKER**—A term applied to a time lock constructed to lock by the action of the clock work at a predetermined hour subsequent to, and irrespective of, the time of closing the door. See *Bank and Safe Locks*, page 220.
- SUB-TREASURY LOCK**—One for use on the iron doors of the small chests or boxes within a fire-proof safe, commonly called "Sub-Treasuries." See *Bank and Safe Locks*, page 223.
- SURFACE HINGE**—Synonymous with Strap Hinge.
- SURFACE SASH CENTER**—One adapted for application to the *surface* of a transom sash.
- SWIVEL SPINDLE**—A spindle having a joint or swivel midway in its length, whereby the knob attached to one end may be made stationary and inoperative, while the knob attached to the other end is left free to rotate, and thus to actuate the latch mechanism. See *Knobs and Spindles*, page 172, Fig. 3.
- TAIL PIECE**—A sliding or vibrating piece intermediate between the hub and latch bolt of a lock for transmitting motion from the former to the latter. See page 10, piece 32.
- TALON**—The notch or opening in the bolt of a lock with which the key engages to throw the bolt. See *Lock Primer*, page 106, Fig. 9.
- T-HANDLE**—A cross handle for actuating the bolt of a lock and used in place of a knob. See page 792, Nos. 7, 8, 9 and 10.
- THIMBLE**—The socket or bearing on an escutcheon plate to receive the knob shank. Also called Socket. See page 10, piece 29.
- T HINGE**—A surface hinge of which the chief dimension of one leaf is vertical and of the other leaf horizontal.

- THREAD ESCUTCHEON**—A small key plate, conforming to the outline of a key-hole and intended to be inserted therein.
- THREE-PLY BUTT**—Synonymous with Pocket Butt. See page 773, No. 60.
- THUMB-PIECE**—A small knob, usually flat, but sometimes circular in form. See page 792, Nos. 1, 4 and 5.
- THUMB-BOLT**—A door bolt operated by a rotating thumb-piece or a small knob. See page 763, Nos. 91 and 92.
- THUMB LATCH**—A door fastening consisting of a pivoted bar which crosses the joint of the door to engage with the strike on the jamb, the free end of the bar being raised to disengage it from the strike on the jamb, by a transverse pivoted bar passing through the door, the latter bar operated on one side by the thumb and on the other by the finger.
- TILL LOCK**—See Drawer Lock, page 18 ; also see page 675.
- TIMELOCK**—One actuated automatically by clock work, and having no key-hole, spindle or other connection through the door. Also called Chronometer lock. See Bank and Safe Locks, page 221, Fig. 1.
- TOILET BUTT**—Synonymous with Water Closet Butt. See page 819.
- TOWEL HOOK**—A straight bar, usually of considerable length and with ball tip. See page 795, Nos. 1606 and 1607.
- TOWER BOLT**—A modified form of barrel bolt, in which the locking bar is shortened.
- TRANSOM**—A horizontal mullion or cross-bar in a door or window. Commonly used as synonymous with transom light. See Transom Trim, page 192.
- TRANSOM CATCH**—A fastening adapted for use on transom lights. See Transom Trim, page 195 Fig. 10, and page 783.
- TRANSOM CHAIN**—A short chain to limit the movement of a transom sash ; usually provided at each end with a plate for attachment. See Transom Trim, page 195, Fig. 11 ; also page 812.
- TRANSOM LIFTER**—An apparatus for actuating and holding a transom light. See Transom Trim, page 194 ; also pages 813 to 815.
- TRANSOM LIGHT**—A sash occupying an opening in the head of a door frame over the transom bar. See Fan Light, page 19.
- TRANSOM PLATE**—Synonymous with Sash Center, page 28.
- TRIPLEX SPINDLE**—A lock spindle composed of three triangular rod which, when combined form a rectangle, and, which give an automatic adjustment by frictional engagement with the knob when expanded by a set-screw. See page 10, piece 26 ; also Knobs and Spindles, page 171, Fig. 2.
- TUBULAR LOCK**—A rim lock having a fixed tube, containing the tumblers, attached to the lock case and usually projecting through the door.

- TUMBLER**—The obstruction or guard in a lock which dogs or prevents the motion of the bolt, and which is set by the key during the act of locking and unlocking. See page 10, pieces 13 and 19.
- TURNBUCKLE**—Synonymous with Turn Button.
- TURN BUTTON**—A rotary bolt or fastening made in various forms. The common form is a simple bar secured by a screw in center on which it rotates. In another form this bar is mounted on a circular plate. See *Minor Fastenings*, page 196, Figs. 3 and 4. The term is also applied to a catch having a sliding bolt operated by a rotating knob or T-handle. See pages 816 and 817.
- UNIT LOCK**—A term applied to a lockset when so constructed that all of its parts (the lock, knobs and escutcheon plates) are permanently combined in a single construction or unit. See page 1080.
- UPRIGHT LOCK**—One whose major dimension is vertical. See page 617, No. 702.
- VESTIBULE LATCH**—A lock resembling a front door lock except in omitting the dead-bolt mechanism. One in which the latch-bolt is actuated from the outside by a key and from the inside by a knob; the outer knob being controlled by a stop. See *Front Door Lock*, page 142, and pages 653 to 660.
- VENEERED FRONT**—A lock front or face consisting of two plates, the lower riveted to the lock case, and the upper (usually of a more expensive material) *permanently* fastened to the lower. Used in contradistinction to "Armored front." See *Wrought Metal Locks*, page 130, Fig. 2.
- WARD**—A projection from the case of a key-hole of a lock, tending to obstruct the entrance of the key, and necessitating a coincident depression or grooving in the key. See *Lock Primer*, page 105, Figs. 1, 2 and 3.
- WARDED KEY**—One having grooves or notches, usually in the wing or bit, which coincide with corresponding wards or projections in the lock case or key-hole. See *Lock Primer*, page 105.
- WARDROBE HOOK**—One with a single prong, for use on the side walls of closets and wardrobes.
- WATER CLOSET BUTT**—A surface butt, usually of irregular outline, for closet seat. See page 819, No. 265.
- WHEEL** (of combination locks)—See *Combination Tumbler*, page 15.
- WINDOW PULL**—See *Sash Pull*, page 29.
- WINDOW SPRING BOLT**—A spring-bolt for holding a sliding sash in any desired position, open or shut; used with unbalanced sashes. See page 809, No 915.
- WING KEY**—One having a wing or projection for operating the bolt or tumblers of a lock. See *Keys*, page 139.

## Explanatory Note as to Method of Pricing.

**A**N important purpose which this volume is intended to serve is to assist not only in the selection of Builders' Hardware, but also in enabling its value to be ascertained with sufficient accuracy for the purpose of provisional estimates and, especially, to furnish indications of *relative values* to serve as a guide to quality and cost in selection, and in the preparation of specifications.

Obviously exact prices cannot be given, for the reason that these are subject to constant fluctuations in sympathy with changes in market conditions. The effort herein has been to indicate prices which are *relatively* in harmony, and which are sufficiently high to cover all contingencies. Usually it will be found in practice that the actual cost will be considerably less than the values herein indicated. By submitting a definite list or schedule of articles to a dealer or manufacturer for estimate, the proportion between a quotation thus obtained and the values indicated in this volume will establish a ratio (as on page 36A) which will probably hold good, at the same date, as to other indications of value contained herein. Probably the chief use of these values, however, will be the indication they afford of the *relative cost* of the different articles and designs to which they apply.

Wherever feasible specific prices are given for each article. In the case of extensive groups of articles, the pricing of which in detail would require undue space, reference is made to a similar group which is fully priced, and a "multiplier" is given which indicates the ratio which the prices in one group bear to those of the other.

In the case of *Ornamental Hardware* each "multiplier" is based on the difference between the aggregate price of a selected number of typical pieces in "Cluny," and the aggregate price of a like number of similar pieces in the design to which the multiplier applies. The actual difference will vary with the kinds and quantities of pieces used, but the approximate value obtained by means of the multipliers will indicate fairly the relative prices of the various designs and in the various finishes.

In the case of *Plain Hardware* the "multipliers" for the various finishes are based in like manner on a selected number of typical pieces.

#### PRICES, SCALES AND MULTIPLIERS.

In *Ornamental Hardware* the Cluny design (priced in detail in Old Copper Finish, CX22, on pages 710 to 735) is used as a *scale* by which to indicate approximately the prices of all other Ornamental Designs by means of "multipliers," that is, figures which indicate the ratio which the price of any other design bears to that of Cluny, various finishes of the same design being indicated by different multipliers.

For example: the multiplier 2.5 indicates that the price of the design in the finish to which that multiplier applies, is approximately two and one-half times that of Cluny (in Old Copper Finish); the multiplier .8 indicates that the price is approximately eight-tenths that of Cluny (in other words, 20 per cent. less than Cluny).

In *Ornamental Lock-sets* the Cluny design is also used as a *scale*, as explained above, the price of lock and trim being given separately in each case. To obtain the price of a lock-set with trim of any other design, convert the value of the trim, as given in the Cluny design, (by using the multiplier given under the design selected), and to the value of the trim, thus ascertained, add the price of the lock.

In *Plain Hardware* (i. e. not Ornamental), specific prices are given in Bronze and Brass in the Buffed finishes (BZ10 and AZ10 respectively). Approximate prices in other finishes may be obtained by means of the multipliers listed below, and in the manner explained on page 34.

Finishes.	Multipliers.
Antique Copper or Brass . . . . .	1.10
Nickel Plate, . . . . .	1.10
Silver Plate, . . . . .	2.20
Gold Plate, . . . . .	9.00
Bower-Barffed Iron, . . . . .	.90

In *Plain Lock-sets* specific prices are given in Bronze and Brass in the Buffed finishes (BZ10 and AZ10 respectively) the price of lock and trim being given separately in each case. To obtain the price of a lock-set in other finishes, convert the value of the trim (by using the multiplier given above) and to the value of the trim thus ascertained add the price of the lock.

#### INDEX TO PARTS CONTAINING PRICES.

Part III contains prices of Ornamental Hardware.

“ IV contains prices of Locks.

“ V contains prices of Locks in sets, complete with trim.

“ VI contains prices of Plain Bronze and Brass Hardware.

“ VII contains prices of various Groups of Hardware.

“ VIII contains prices of Ornamental Cabinet Hardware.

#### PRACTICAL EXAMPLES.

To illustrate the method of using the system of pricing herein adopted the following practical examples are given.

Where specific prices are given they are to be used.

Where the text indicates that a “multiplier” must be used, follow the instructions given on page 34.

In examples I, II and III page references are inserted to assist in explaining the method of using this book to obtain

approximate estimates of cost ; in practical work they may be omitted, as shown by examples IV and V.

The ratio between the values herein indicated and current market values may be established in the manner explained on page 33 ; having done so, the corresponding correction should be made as indicated at the foot of Example IV.

#### EXAMPLE I. ONE PAIR FRONT DOORS.

The Lock Trim and Push Button in Bristol Design, all other items in Plain Brass ; all in Buffed Brass Finish (AZ10).

3 Pairs Butts, No. 750, 5×5 inches (page 777), at \$9.30 per pair . . . . .		\$27.90
1 Flush Bolt, No. 283, 12 inch (page 770), say . . . . .		6.00
1 " " " " 24 " " " " . . . . .		10.00
1 Lock, No. 750 (page 656) . . . . .		14.50
Lock Trim, on Cluny basis (page 711) . . . . .	\$13.85	
1 Push Button, No. 1415, on Cluny basis (page 735) . . . . .	3.25	
Total, on Cluny basis . . . . .	\$17.10	
"Multiplier" for Bristol Design in AZ10 finish, ".9" (page 549), thus, 17.10 × .9 . . . . .		15.39
		<u>\$73.79</u>

#### EXAMPLE II. ONE BEDROOM DOOR.

The Lock Trim in Chester Design (outside), and Fairfax Design (inside) ; Butts and Lock Front in Plain Bronze ; all in Buffed Bronze Finish (BZ10).

1½ Pairs Butts, No. 780, 4½×4½ inches (page 777), at \$6.00 per pair . . . . .		\$ 9.00
1 Lock, No. 1500 (page 636) . . . . .		3.00
Lock Trim, on Cluny basis (page 717) . . . . .	\$ 8.00	
"Multiplier" for Chester Design in BZ10 finish, ".9" (page 549), thus, 8.00 × .9 . . . . .	\$ 7.20	
"Multiplier" for Fairfax Design in BZ10 finish, "2.5" (page 551), thus, 8.00 × 2.5 . . . . .	20.00	
Only half trim used on each side ; therefore ½ of	\$27.20 =	13.60
		<u>\$25.60</u>

#### EXAMPLE III. ONE PAIR FRENCH WINDOWS.

The Bolt in Fairfax Design and Butts in Plain Bronze ; all in Buffed Bronze Finish (BZ10).

3 Pairs Butts, No. 780, 4×4 inches (page 777), at \$5.10 per pair . . . . .		\$15.30
1 Cremorne Bolt, No. 893, Fairfax Design (page 887) . . . . .		41.50
1 Flush Bolt, No. 280, 12 inch (page 770), say . . . . .		6.00
		<u>\$62.80</u>

WORKING EXAMPLES.

To facilitate the conversion of values from the Cluny base a separate column may be provided for each design. The value of the articles in each design, on the Cluny base, are then extended in the appropriate column, the footing of which gives their total. The application of the proper multiplier to this footing gives the total value of the article specified in the design and finish selected, and this figure can then be carried into the final column, the footing of which gives the total value of the goods covered by the schedule on the basis of the price system adopted in this volume. The manner of converting this to current market value is also indicated.

The result, as explained on page 33, will be an *approximation* to actual cost, which usually will be found sufficiently accurate for provisional estimates.

EXAMPLE IV. FOR RESIDENCE.

(Page references omitted).

		—On "Cluny" Basis—		Plain
		Medford.	Chester.	Goods.
1	PAIR FRONT DOORS, RIGHT HAND—			
3	Pairs Butts, 750, 6×6 inches, AZ10	. . . . .	. . . . .	\$43.05
1	Bolt, 283, 12 ins. . . . . "	. . . . .	. . . . .	6.00
1	" " 24 " . . . . . "	. . . . .	. . . . .	10.00
1	Lock, 750 . . . . . "	. . . . .	. . . . .	14.50
1	Set Medford Trim . . . . . "	\$13.85	. . . . .	. . . . .
1	" " " (dummy) . . . . . "	13.85	. . . . .	. . . . .
1	Push Button, 1415, Medford, "	3.25	. . . . .	. . . . .
1	PAIR SLIDING DOORS—			
1	Lock, 1706 . . . . . AZ10	. . . . .	. . . . .	8.40
4	Cup Escutcheons, Chester . . . . . "	. . . . .	\$12.00	. . . . .
5	BEDROOM DOORS—			
7½	Pairs Butts, 780, 4½×4½ ins., AZ10	. . . . .	. . . . .	45.00
5	Locks, 1500 . . . . . "	. . . . .	. . . . .	15.00
5	Pairs Glass Knobs, G67, 2 roses, "	. . . . .	. . . . .	53.75
10	Key Plates, 803, Chester . . . . . "	. . . . .	4.50	. . . . .
10	DOUBLE HUNG WINDOWS—			
10	Sash Fasts, 1372 . . . . . AZ10	. . . . .	. . . . .	12.50
20	" Lifts, 1349, Chester . . . . . "	. . . . .	22.00	. . . . .
	Plain Goods . . . . .			\$208.20
	" Mult'r " for Medford, (AZ10) 1.3×	30.95=		40.25
	" " Chester, " .9×	. . . . .	38.50 =	34.65
				Total, \$283.10
	Discount to conform to market, say 50 per cent. . . . .			141.55
	Approximate value, say . . . . .			\$141.55



## EXAMPLE V. FOR RESIDENCES.

(Page references omitted.)

## PARLOR

		Value in Plain Bronze Buffed.	Value in Finishes Selected.
1 PAIR SLIDING DOORS, OFF HALL—			
1	Lock-set, 1706 X 70854 . . . . GY10	\$20.00	
5 DOUBLE HUNG WINDOWS—			
5	Sash Fast, 1372 . . . . . "	6.25	
10	Sash Lifts, 71349 . . . . . "	8.00	
		<hr/>	
	"Mult'r" for Gold (GY10) 9 X	34.25	= \$308.25

## DINING ROOM.

1 DOOR, OFF HALL—			
1 1/2	Pairs Butts, 780, 4 1/2 X 4 1/2 . . SY52	\$9.00	
1	Lock-set, 1500 X W56 X 3/7410 "	7.00	
3 DOUBLE HUNG WINDOWS—			
5	Sash Fast, 1372 . . . . . "	6.25	
10	Sash Lifts, 71349 . . . . . "	8.00	
		<hr/>	
	"Mult'r" for Silver (SY52) 2.2 X	30.25	= \$66.55

## BEDROOMS.

5 DOORS, OFF HALL—			
7 1/2	Pairs Butts, 780, 4 1/2 X 4 1/2 . . CX22	\$45.00	
5	Sets 1500 X W56 X 3/7410 . . "	35.00	
10 DOUBLE HUNG WINDOWS—			
10	Sash Fast, 1372 . . . . . "	12.50	
20	Sash Lifts, 71349 . . . . . "	16.00	
		<hr/>	
	"Mult'r" for Copper (CX22) 1.10 X	108.50	= 119.35

## BATHROOM.

1 DOOR, OFF HALL—			
1 1/2	Pairs Butts, 780, 4 1/2 X 4 1/2 . . NZ10	\$9.00	
1	Lock-set, 1505 X W56 X		
	3/7830 X 3/7831 . . . . . "	7.45	
1 DOUBLE HUNG WINDOW—			
1	Sash Fast, 1372 . . . . . "	1.25	
2	Sash Lifts, 71349 . . . . . "	1.60	
		<hr/>	
	"Mult'r" for Nickel (NZ10) 1.10 X	19.30	= 21.25

---

 Total . . . \$515.40

# Part I.

---

Narrative and Historical.

## Part I.

---

### Narrative and Historical.

Section.		Page.
1.	Lock-Making and Art Metal Working in America,	39
2.	Artistic Hardware, . . . . .	45
3.	Artist and Artisan, . . . . .	57
4.	A Bit of History, . . . . .	65
5.	The Yale Lock, . . . . .	71
6.	The Story of an American Industry, . . . . .	79
7.	Evolution in Lock Designing, . . . . .	88
8.	Historical, . . . . .	89

## Section 1.

---

### Lock-making and Art Metal Working in America.\*

**O**F these two allied arts, rightly classified among the hand-  
maids of architecture, the first has been revolutionized  
and the second practically created during the period  
since 1870.

Lock-making in America has largely been influenced by national character and environment. The locks first made here naturally followed European practice, but almost from the beginning a differentiation began by the substitution of cast for wrought metal. The European locksmith has always worked chiefly in wrought metal, fashioning it by hand into the finished product, whereas in America the higher cost of labor has precluded the employment of artisans of this type and compelled resort to less costly methods of production.

Influenced by these facts, the American lock-maker turned naturally to cast material in place of wrought, stimulated thereto by the superior quality of American cast iron. This change of material greatly reduced the cost of production, and soon led to changes in design from which was developed the now familiar American type of lock. The methods of production thus adopted minimized labor by producing in the foundry castings practically ready to be assembled and requiring only a trifling amount of drilling, filing or polishing to convert them into finished locks. But few machines were required, and these of the simplest character.

\* Written by the author and reproduced, by permission, from "A History of Architecture in New York," 1898.

See also companion paper constituting Section 2.

The product was handsome in appearance, of good mechanical action, and admirably served its purpose. Thus stood the art in 1870. The leading lock-makers desired and sought steadily to improve their product, but, unfortunately, influences were at work to pervert their methods of manufacture and to deteriorate their product. Competition, always active, prompted efforts to reduce the cost which ended in great debasement of quality, especially in the cheaper grades of goods, and under these conflicting influences the mechanical advancement of the art halted.

At about this time there was quietly introduced in the American market a novel lock product destined to revolutionize the industry. This was the outcome of the invention, by Linus Yale, Jr. (then the leading American maker of bank locks), of



Fig. 1.

a key lock for general use of the type now known throughout the world as the Yale (or "cylinder") Lock. Its most striking feature was its key, the original form of which is shown by Fig. 1.

The mechanism of this lock precluded its production by ordinary methods and necessitated the employment of machinery of the same type as that already adopted in the manufacture of fire arms, sewing machines, etc. The makers of the Yale Lock were therefore forced to evolve new methods of production suited to the new product, and this fact in turn had a marked influence upon the product itself. The new product was thus subjected from the outset to two dominating influences, emanating from the characters and aims of the men by whom the enterprise was started, viz.: that resulting from the application of new ideas and inventions involving radical departures from accepted lines of construction, and that resulting from a higher ideal of mechanical execution and the utilization for this purpose of improved machinery and processes.

The standards adopted in connection with the new product thus begun have since been so generally incorporated into American practice as to call for a brief reference to their origin. The new industry was organized in October, 1868, at Stamford, Conn., by Linus Yale, Jr., and Henry R. Towne. The former died prematurely in December of the same year and the enterprise, under the corporate name of The Yale & Towne Mfg. Co., has since been conducted by the latter as President; its work, which originally required only thirty employees, now requiring, under normal conditions, nearly three thousand, and its products embracing a vast variety of articles.

The fundamental features of Mr. Yale's inventions were (1) a small flat key; (2) the combination of this key with pin-tumblers; (3) a tumbler case or "cylinder" bearing a fixed relationship to the surface of the door and connected with the bolt work in the lock case; and (4) the adoption of heavier parts and better



Fig. 2.

proportions in all important details. Among the many features since added by those who have carried forward the work so well begun by Mr. Yale are (5) the adoption of a higher standard of mechanical design; (6) the employment in manufacture of the most modern machine tools and processes; and (7) the application to the visible parts of locks and other hardware of the true principles of decorative art, which was accomplished by seeking the coöperation of architects and other professional designers in this field.

The original Flat key of Mr. Yale was superseded about 1882 by the improved Corrugated key, shown by Fig. 2, and this in turn, about 1892, by the still better "Paracentric" key now used with all genuine Yale Locks and shown by Fig. 3 on next page.\*

\* See also Section 5, The Yale Lock

At first the conditions involved implied, unavoidably, much higher cost for the Yale Locks than those for ordinary character, but this difference has steadily diminished until to-day the Yale Lock is the accepted standard for all uses where excellence or security are the requirements.

Recognizing the fact that, for many uses, locks of less elaborate character are needed, the makers of the Yale Lock undertook, years ago, to elevate the character of common locks by designing and making a complementary line of Builders' Locks having the same high quality of design and workmanship as the Yale Lock, but comparing in cost with locks of the ordinary type. To this end they introduced, about 1873, the line of "Standard



Fig. 3.

Locks," (the features of which, proving to be sound and correct, have since become standard in the trade and have been reproduced more or less closely by all of the leading manufacturers) and

about 1890 made a further advance by introducing a mortise door lock made of wrought steel in place of cast iron, which immediately proved popular and was quickly followed by a line of wrought metal locks made by the Russell & Erwin Manufacturing Company, which also have enjoyed large sale. Still later the Warner Lock Company introduced a very attractive line of wrought steel locks, the popularity of which has confirmed the soundness of this change in material.

Recently The Yale & Towne Manufacturing Company has made a still more radical advance by the introduction of its line of Vulcan Locks,\* in which every part is formed of wrought material, made by machine processes and therefore interchangeable, and which embodies also improvements in lock mechanism almost as radical as those of the original Yale Lock. Other lock-makers

\* See Part II. Section 5, Wrought Metal Locks.

have followed many of the leads thus opened, and the whole product stands to-day on a higher plane of design and execution than ever before, and the work of American lock-makers easily excels that of all others.

Coincidentally with the development of the art of lock-making in America during the past twenty-five years, which has been traced in outline above, there has occurred an equal, and in some respects more surprising, development in the application to the Hardware of Ornament (especially to that used with locks), of true principles of artistic design. This subject is discussed elsewhere,\* as to its artistic qualities and effects, but a few words concerning it may be permitted here as to the mechanical developments which made it possible.

The earlier efforts at decoration in hardware were feeble, crude and meretricious. Credit is due to the Russell & Erwin Manufacturing Company for being the first to perceive the opportunity for better things in this field and, by the introduction of their designs in "Compression Bronze," about 1872, to introduce ornamental hardware thoroughly excellent in design and admirable in execution. A little later further progress in this field was made by Hopkins & Dickinson, but for some reason, possibly because the time was not yet ripe, these earlier efforts were not persisted in, and the advance was not maintained. The stimulus of the Centennial Exhibition in 1876, upon American art, was speedily felt, however, in the field of hardware, and soon resulted in a development of far-reaching character. In this, as in the line of mechanical advancement, The Yale & Towne Manufacturing Company took the leading part, being greatly aided by the improved methods of production which it had been forced to devise in accomplishing the improvements in design, workmanship and finish embodied in its

\* See Section 2, Artistic Hardware.



mechanical products, as already explained. Aided by that experience, it found effective means for producing economically the elaborate, beautiful and varied work of decorative character suggested by the drawings of the architects and skilled designers whose professional assistance it sought. In the attainment of this end it made use of all the processes and appliances known to the arts of the modeler, the molder, the chaser and finisher, supplementing them wherever advantageous by those of the metallurgist, the mechanic and the chemist.

Out of this union of old-world skill and training in the decorative arts, and of new-world ingenuity and facility in the mechanical arts, has sprung an entirely new product, rivaling in artistic qualities the best work of the past, and produced at a cost which makes it available for almost every purpose of use or embellishment, thus bringing, in this field of decoration, the true principles of art literally to the doors of all classes in the community, and thereby contributing in no small degree to the education of the people, both in the appreciation and the employment of true art in all its forms.

We have mentioned here only the names of those who have been leaders in the evolution of American locks and hardware during the past twenty-five years toward higher mechanical and artistic excellence, but the efforts of these leaders have been greatly stimulated and reënforced by those of their competitors. It is true that interested motives underlay these efforts, but in a certain sense that statement applies equally to all artistic work, and credit is none the less due to those who have borne their part in the advancement of this important national industry whose record we have endeavored to trace in this brief outline.

## Section 2.

### Artistic Hardware.\*

**U**NTIL about twenty years ago no real attempt had been made to give any artistic character to the metal work used in the buildings in the United States, or, indeed, to any other metal work whatever.

The cast iron stoves were often crowned or incrustated with what the makers of them imagined to be ornaments, but nothing could be cruder, more inappropriate, or, to an educated taste, more offensive than these applications.

They were even cruder than the British product of the same period, and it was doubtless the crudity of this product that led Ruskin to say that "no ornaments are so cold, clumsy, and vulgar, so essentially incapable of a fine line or graceful shadow, as those of cast iron."

As we shall see, the critic spoke, as he has so often done, in his haste, and transferred the intractability of the material to what was really the incompetency of those who had undertaken to handle it for any purpose but that of strict utility. Cast iron, setting aside its liability to oxidation, is as available a material, as "capable of a fine line or graceful shadow" as cast bronze, and as available, not alone for purposes of ornament, but as Russian founders have shown, even for figure-sculpture. Forty or even thirty years ago the American who was sufficiently cultivated to be



About 1870.

\* Written, at the author's suggestion, by the well-known architectural critic, Mr. Montgomery Schuyler, of New York, and reproduced by permission from "A History of Architecture in New York," 1898.

See also companion paper constituting Section 1.

revolted by the false pretense of art in the metal fittings of his house had no resource but to deny himself any pretense of art, and to take refuge in an absolute simplicity, which was only the absence but not the negation of the artistic element. In costly houses the hinge plates and door knobs and escutcheons showed plain surfaces of metal, of which the utmost pretension was to be silvered when they were applied to the solid mahogany doors of the period. In the less conspicuous rooms the knobs and their roses were of brass, or still oftener, of smooth white porcelain. The effect was not in the least artistic, but it was highly respectable. Meanwhile, it was the cheaper work which was known to the trade and to the public as "fancy." In this it was attempted to make up for the lack of evidently costly material by the addition of the ornament. This was not art, for the reason that, as has been well said, "art is something done by an artist."

This ornament was designed by the pattern-makers, who were entirely untutored, either in the principles or in the historical examples of ornamental design. They were as incapable of conventionalizing natural forms with due regard to the purpose of the design and the material of which, and the processes by which, it was to be executed, as they were ignorant of the distinguishing features of historical styles. Their work, accordingly, could be neither pure nor peaceable, and could have none but a degrading effect upon the taste of those who had its results continually before their eyes. It is only "something done by an artist" that can educate the public taste to demanding something better than is supplied to it, and in this department there were no artists at home, and no examples imported from abroad and so exhibited as to have any educational effect upon manu-

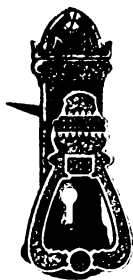



About 1875.

facturers or purchasers. Up to 1870, it may be said almost without reservation, there was no choice for the purchaser of hardware except between work which was simply unrelated to the sense of beauty and work which was revolting to it.

In order to see what the state of things was, it is necessary to resort to illustration. It is unnecessary to reproduce any of the plain unpretentious and inoffensive work for the reason that there is nothing in it to illustrate, and also for the reason that it continues to be made and to enjoy a considerable vogue. There are cultivated, but timid, persons who desire to be on the safe side, and who are conscious that entire simplicity is safe. They know that it is inoffensive, and that what used to be the "fancy" articles submitted to them in this line are abominable, and they are unaware that positively artistic and attractive work is to be had. If the choice were still between work negatively inoffensive and work positively repulsive, they would be quite right. It would be a mistake to

suppose that such work has been altogether expelled. In some very recent trade catalogues "fancy" hardware, as crude as that of 1870, continues to be offered, and to be offered at high prices, and obviously it would not continue to be offered if it did not continue to be demanded.

Again, there are architects who, although they can scarcely help being aware that there is now a choice between what is inoffensive and what is attractive, as well as between what is inoffensive and what is re-

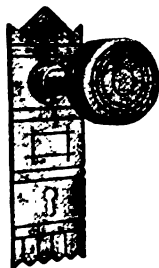
About 1876.  
"Eastlake"



About 1877.

pulsive, do not take advantage of their knowledge, and are still content to be "safe."

Although the crude and unconsciously grotesque "fancy hardware" of the last generation continues to be made, it is no longer familiar to those who would be likely to be offended by it. Some typical examples are accordingly presented, culled for the most part from old trade catalogues, but some also, as will be seen, almost as

bad as the worst, from catalogues found almost within the present decade. It will be seen from the illustrations that these attempts were as irrational as they were inartistic, and that the most suitable and convenient forms which were adhered to in the common commercial work, were abandoned in the fancy work for forms that were practically inconvenient. Rather, their irrationality was a part of their ugliness. A great critic has said "a thing has style when it has the expression appropriate to its uses," and this expression, though it may be heightened by modeling and decoration, cannot be attained at all unless the object has, in the first place, the form appropriate to its uses.



About 188c.

It was in 1872 that the first definite promise of better things was made. This was in the work of the Russell & Erwin Manufacturing Company. It consisted, as is evident, in the employment of a trained designer, in the first place, to rationalize, and, in the second place, to decorate, the forms which had been in the first place distorted, and in the second defaced, with no more rational and artistic purpose than to produce something "fancy." Func-

tion, material and process are recognized in these essays, and that recognition is the beginning of progress. These early attempts may now seem crude enough, but it is to be borne in mind that the vast improvement which has since been effected is not alone an advance in design. It is an advance also in the mechanical execution of the design, in which mechanical labor has risen into artistic craftsmanship.

This advance is dependent upon the coöperation with the artistic designer of an enlightened manufacturer, who is willing to take trouble to secure better results, and to make expenditures upon experiments, and the process takes time as well as trouble and money.

Undoubtedly, however, the main stimulus to the Renaissance, or, rather, the "Naissance" in this country of artistic handicraft in this branch, as in so many other branches, was the Centennial Exposition of 1876.

The notion that the general design of a dwelling might be carried into its details and fittings, so that all the parts should be "of a piece," was practically new to most visitors.

Only in churches and public buildings, especially in churches, had it been attempted heretofore, and even in these it had been very imperfectly performed. It was precisely in the particular of metal fittings that the shortcomings were most manifest, and this for the reason that the architect had not



About 1884.



About 1887.



About 1890.

and simplest objects that could be had, to content himself with the humbler attainment of mere inoffensiveness.

The first essays in the direction of making the hardware of a house conform to its furniture and fittings were not very successful, for the reason that they were experiments in a passing fashion. The Gothic revival was at that time in full possession of the architectural field in England, and commanded also the sympathy of the most thoughtful and progressive American architects. But the attempt to apply the principles of Gothic art to



About 1891.

had the coöperation of the manufacturer. In masonry and in woodwork the designer could secure the execution of his design. But in cast metal the cost of a special set of castings for an ordinary dwelling house or commercial building, was quite prohibitory. The architect, even when he was consulted, was forced to limit himself to what could be found "in stock." As there was nothing there that was exactly suitable to his purpose, he was forced to abandon the attempt to make these fittings a positive enhancement of the effect of his work, and taking refuge in the plainest

furniture constructed by modern methods, had resulted only in what was called "Eastlake Furniture," which was even then suspected, and is now generally recognized to be ugly and cumbersome. The Eastlake hardware was an improvement upon what had preceded it, in that it was designed with reference to the materials and the process employed, but its forms failed to commend themselves as beautiful or appropriate, and now appear hopelessly antiquated. Neverthe-

less, in so far as they proceeded from a real consideration of material and function they contained the germs of progress. Later work upon the same lines showed a real development, and it continued to be made by some firms, and with increasing success, down almost to the present decade.



About 1892.

But meanwhile, a much more comprehensive movement had been begun, and it had been begun under happier auspices. That is to say, it was marked by the coöperation of artistic designers, and of manufacturers who were willing to take trouble and to spend money in securing artistic results. It was about 1883 that the Romanesque revival, stimulated by the success and vogue of the works of Richardson, had begun to make its way over the country, and had enlisted the active-minded and progressive young architects, the successors of those who, in the previous decade, had given themselves to the advancement of Victorian Gothic, and in some cases the same persons. The Romanesque had taken almost undisputed possession of the West, and along with those of its practitioners, who followed it simply because it was the fashion, there were others who believed in it, and who were earnest in following out its possibilities. Chicago was the centre of this cult in the West, and several of the most capable of the designers of Chicago became interested in the efforts of The Yale & Towne Manufacturing Company to produce much more artistic work in cast metal than had been produced heretofore. Among



About 1892.





About 1892.

these were John W. Root, Louis H. Sullivan and W. B. Mundie. Many of the designs procured from them are still current and among the standard products of the company for which they were made. They were so manifestly superior to anything that had been done before in this country, that a distinct demand for artistic hardware followed upon the supply of it. The demand thus created soon stimulated other manufacturers to follow the lead thus opened; sometimes through more or less direct imitations of successful designs, more rarely by the same means by which those designs had been

produced; that is to say by the employment of competent designers.

But, although the results of this employment were so gratifying they were not at this stage completely satisfactory. A main charm of artistic handicraft is that in such handicraft the designer is also the artificer. No execution of an

architect's drawing by a mere mechanic, never so highly skilled, can replace the attractiveness of the work in which the workman is shaping the creation of his own mind. It is this which distinguishes the stone capitals, the wooden furniture, the metallic grilles and hinges and latches of the best mediæval work from the most successful modern reproductions or imitations. Of course this method is not directly applicable to modern manufacturing conditions, in which the artistic end



About 1893.

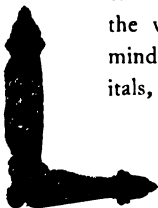

A bout 1894.



About 1895.

must be attained within a predetermined limit of cost. The closest approach to it is made when the designer works in the closest possible connection with the workman; when he does his designing in the factory in which it is to be executed, and acquires by daily contact, an intimate, almost intuitive, knowledge of the possibilities of the means by which his design is to be reproduced. This is the first condition of progress in industrial art. Moreover, in cast work there is necessary the intervention between the design and the product of a sympathetic and highly skilled artisan in the modeler, whose intelligent coöperation is required for the interpretation of the design. After the casting is produced, hand work is again brought into requisition for the finishing touches. In the work of the highest class, and also necessarily of the greatest cost, there is scarcely any limit to the extent to which this finishing work may be carried. When hand chasing is applied by an artistic artisan without restriction of time or money, the result even of a casting is an original work of art. But evidently for the production of such work by modern industrial methods, it is necessary that the employer should himself be appreciative of the value of artistic effect, and willing, as has been said before, to bear the expense of experiments toward improving them. When all these conditions concur, the result is the closest approach possible in our modern wholesale and commercial production to the art-work of ancient craftsmanship.

Happily, all these conditions concurred in



About 1895.



About 1895.

the case of The Yale & Towne Manufacturing Company, the pioneer in the production of artistic hardware in America, and, as a consequence, the work of this kind produced here within the present decade by them, and by others who have followed them, far surpasses in artistic merit that produced in any other country, excepting only in France. France is our only competitor in quality; in cheapness of production, and, therefore, in general acceptability, there is no competition, so much larger is here the use of labor-saving machinery, and so extensively has it been invoked by American manufacturers without detriment to the artistic quality of the product.

In range and variety there is no comparison between what may be seen in the catalogues or in the show-rooms of the leading American manufacturers. The advantage on the part of the American manufacturers in variety of design comes in part from the much greater variety of architectural styles habitually employed by American architects. While in Europe the different rooms of a dwelling of much pretension may be finished in different styles, or in distinct modifications of the same national styles, there is no such variety, either in domestic or commercial architecture, as obtains in this country. Greek, Romanesque, Colonial, Moorish, several phases of the Gothic and several national varieties of the Renaissance, with several subdivisions of each, are all current modes of



About 1896.

building to any one of which the interior fittings may be required to conform. Of each of these there are to be had the objects of which "Builders' Hardware" consists, designed and executed with archæological accuracy, and with high artistic skill. Considering the fewness and simplicity of these objects, escutcheon plates, knobs, handles, hinges, etc., the wealth and profusion of design which have been applied to them are wonderful. The choice is no longer, as formerly, between things plain and merely inoffensive, and things "fancy" and revolting. It is a choice between adornments that are positively attractive, and the sum of which constitutes one of the most striking and successful of American achievements in "applied art."

Although twenty years almost covers the period of this artistic development, it has had many phases. At the beginning of it the best that could be had in this way was a costly material treated with the utmost plainness. This refuge is still regarded as the only safe one in some parts of the United States, and, rather curiously, especially in Boston, where the artistic treatment of common subjects might have been expected, if anywhere, to receive a welcome. As a matter of fact, the West, which, as we have seen, was very largely concerned through its designers, in the production of this phase of household art, is still much in advance of the East in its appreciation.

Costly materials, even the precious metals, are still employed, but even in these "the workmanship surpasses the material," and equally beautiful results are obtained from the humbler metals. The dictum of Mr. Ruskin, which we have quoted at the beginning of these remarks, has been triumphantly refuted



About 1897.



About 1898.

by the work of American foundries. Bronze is still the metal most employed, but the adaption to ornamental hardware of the Bower-Barff process, which, if it does not render iron absolutely "rustless," at least very greatly retards and mitigates its oxidation, has given to cast iron a new availableness. This adaption was successfully made, after a series of experiments, by The Yale & Towne Manufacturing Company, and unpainted and confessed cast iron thereupon became a noble as well as a useful metal. In beauty of surface, in plasticity, in "capability of fine line and graceful shadow," it appears, for places and purposes to which its use is appropriate, the most beautiful of all. This peculiar beauty it owes to the "dead finish" which it is especially capable of receiving, and to the successful efforts which have been made to attain a characteristic treatment in design, as well as in the details of execution. \* \* \* \* \*

Perhaps the greatest achievement in the treatment of bronze is the imitation, by chemical process, of the patina, which is the result in antiques of the slow verduring of time. The common imitations of this patina by pigment are untrustworthy and transient. The patina chemically produced is the thing itself, and is one of the highest achievements of the American development of artistic hardware, which, in turn, is one of the most important contributions to this country of the advancement of industrial art. †

† See also Part III, Section 7, Metals and Finishes.

## Section 3.

### Artist and Artisan.\*



**I**N a most interesting address, delivered many years ago, upon the subject of the relation between the Artist and the Artisan, the late Cardinal Wiseman drew a graphic picture of the difference between the industrial art of former times and the dilettanteism of to-day. As an apt illustration he described the entrance of an old Roman householder into one of the modern museums of antiquities and curios, and depicted him ordering the various articles to be put back to their proper uses. Vases, urns, and other vessels of most artistic form and ornament, he promptly sent to the kitchen, for which they were intended.

A rare mosaic pavement, which the modern lover of art had protected with a heavy railing, was relaid in the entrance way, to be trodden under foot by every passing slave, and so in turn each rare and beautiful object of art was dismissed to some office of service in which its artistic side was made secondary to its useful function, and the empty show-cases were thrown aside as useless.



\* Written at the author's suggestion by Mr. Henry Harrison Supplee, and originally printed in brochure form.



THE lesson which the wise Cardinal sought to teach has not been altogether lost in these latter days of household art, and in the new Renaissance of true artistic taste, the union of artist and artisan and the combination of the beautiful with the useful are once more seen.

In a new country like our own, the growth of taste in household art and the appreciation of the right use of art work come only with increase of leisure and the relaxation from daily business ; but, as the influence of culture, art, and travel grows daily more powerful, so the great tide of public sentiment follows the lead which only a brief time before seemed far in advance.

Instead of looking only to art galleries and public collections for examples of art work, and being content with an occasional glimpse of some rare bronze or exquisite forging through the panels of a cabinet, the American connoisseur demands not only

possession, but also the daily use of articles which a few years ago would have been cherished in some museum of fine arts.

This is true especially of the great and constantly increasing field of art which includes all forms of metal work used in household decoration. The

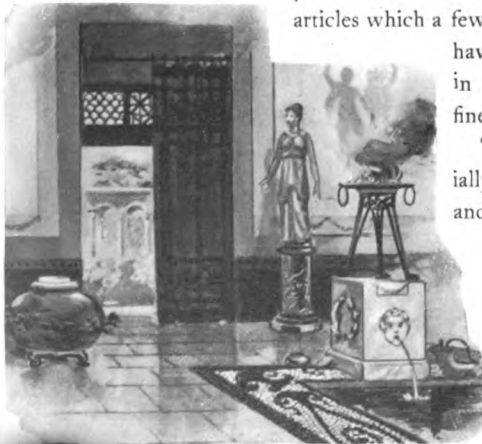

modern collector of the works of the modern artisan makes his house the cabinet in which these works are placed, and, instead of keeping them under glass in an art gallery, he puts them to their rightful use, to be seen and handled by all who come and go.

The entrance door of his residence bears an escutcheon plate which is itself a gem of art work in a precious metal or fine bronze, while the strong yet graceful hinge-straps are examples at the same time of artistic design and skillful interpretation.

Passing on through the inner door, in which a wrought grille of exquisite tracery is set, we notice the fitness with which all the metal is chosen to accord with the surroundings. The elaborate detail borne by the escutcheon plate of the outer door is in perfect harmony with the ornate Renaissance work upon the capitals and cornice above, while within the same motive is modified in treatment and finish to harmonize with the altered conditions. Passing from room to room, the evidence of artistic taste is apparent, and, without ever becoming obtrusive, the metal work is everywhere seen to assert its rightful position as a fitting subject for treatment at once appropriate and beautiful.

Is this the palace of a prince, or the home of a millionaire, through which we have so hurriedly glanced? It is indeed a house beautiful, but there are many other such of equal beauty and yet not of extravagant appearance. If such examples of the metal-worker's art can be so freely distributed, there must be some





readier way of procuring them than the method which gave existence to the art work of the older days. Only king or pontiff could command the skill of a Benvenuto Cellini to form the mould and handle the graver and chasing tools, and here is work which compares with that of the old times, on the doors and windows of residences and hotels, churches and business-blocks, far exceeding in variety and quantity the possible results of individual labor and skill. At the same time, the art metal work is in appearance and character so far above the so-called manufactured articles that no comparison is to be made.

Yet, if organized production under skillful supervision, with all the great advantages which accompany the facilities for making, handling, and display possessed by organization, constitute manufacturing, these products of the highest artistic merit are manufactured; and it is the result of a system of manufacture which retains the individualism of the artist, and adds to it the productive capacity of a thousand artisans, which makes the use of modern art metal work a household possibility.



WHEN the householder of to-day seeks a new home, he calls to him the architect to prepare plans and elevations, and to put into practical form for construction the ideas which he has in mind, and also to guide by counsel and experience the plans

which he hopes to see realized in the completed building.

It is in this work that the client and architect may, if they will, find most pleasing and congenial employment, and the pleasure of witnessing the realization of the long-studied plans in the home where perhaps many coming years are to be spent.

In all this work, the interest increases as the house approaches

completion, and not the least interesting portion of the work is the selection of the metal trimmings and ornament. In this branch of the decoration of the house, the new order of treatment is a revelation to many, and often the client, from lack of information, fails to profit by what has already been done by specialists in art metal work.

He has no wish to turn over to the mechanical taste of the builder the selection of the metal work, which, though part of the useful hardware of the building, should be also conspicuously a portion of its artistic decoration. Yet, as in the older days when art was truly recognized, the artistic instinct is to ornament in a consistent spirit the mechanical devices which are to be used for strength and security, and, to select such objects intelligently, a knowledge of mechanical excellence must be combined with artistic taste.



It is here that the systematized production of art metal work for household use and decoration, made under all the favorable conditions of organized manufacture, enters the field to give practical solution to the problem of the union of the artist and the artisan, and it is by such means that the modern house beautiful is enabled to bear at every turn the products of artistic taste in bronze, or brass, or beaten iron.

The organization by which the production of these objects of art and usefulness has been so notably advanced is The Yale & Towne Manufacturing Company, and by the earnest and intelligent efforts of this Company the possibilities of art industry in metal work have been revealed. It is to its warerooms in New York, Chicago, Philadelphia, and Boston that the master (and often the mistress also) of the house turns, and, accompanied

by his architect and adviser, examines and considers the examples from which his choice may be made.

Here are objects of art metal work in the schools of all times and lands: delicate Byzantine tracery, bold and rugged Romanesque work, the later Gothic, our own Colonial and many others. The plans and sketches which embody the design for the building may here be studied and compared with the escutcheon plates, knobs and hinge-straps which are to be used, and the true consistent effect and balance of proportion kept always in sight.

Should the building be constructed with all the revived classical feeling of the Renaissance, here will be found plates and knobs exquisitely chased by the skillful hands of artists in metal work, and richly plated with silver or gold, while the hinge-straps retain the severe outline of the school, though bearing on their surfaces the same delicate work.

Perhaps it is a country house after the Elizabethan time, or a Colonial mansion, for and in either case the examples in abounding vari-

ety from which selection no inspection is needed to assure the critic that the locks and fastenings for which these articles are

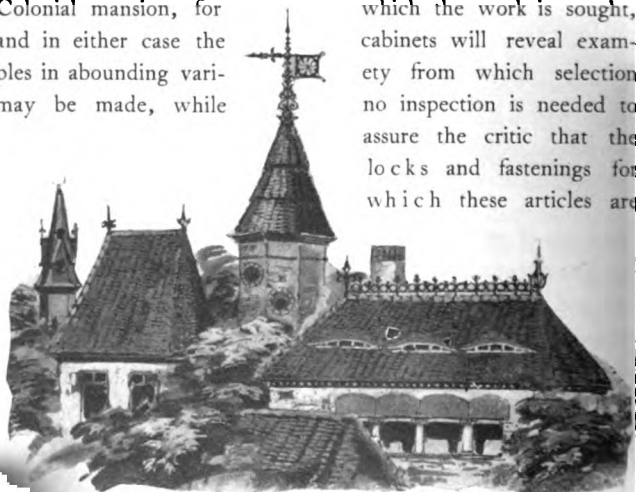

adapted embody the highest mechanical excellence. Not only for the outer fastenings and ornament of the building, but also for interior work, the same great variety of articles is made. Cabinet hinge-plates, drawer-pulls, and key-plates in many artistic ornamentations are in great profusion of design and adapted for all situations, and the same artistic skill which marks the execution of the larger work is revealed in the smaller cabinet trimmings.

It is not only the metal work itself, but the metal work in combination with its surroundings, which must influence the choice of the builder of the house, and to this end the numerous examples are placed in appropriate settings by being mounted upon suitable panels of wood, with the finish best suited to display to highest advantage the combination of wood and metal, and these cabinets of examples may serve at the same time to guide in the choice both of metal trimmings and finish of wood-work.

In connection with this survey of the artistic side of modern metal work, there is also a utilitarian side to be considered; one which is fully equal in importance to the former, and with which it is combined to form a consistent whole. All these varied subjects of artistic design are intended to be used with locks and other fastenings of security, and to this branch of the artisan's work have been brought care and skill not inferior to the art of the designer. The



results of these efforts are the world-famous Yale Locks, giving such infinity of combinations and united qualities of greatest security and compactness that they are far in advance of all other locks for every purpose. Many forms of Yale Locks have been designed, all of which are adapted to be used with the most artistic subjects in metal ornamentations, thus forming combinations of beauty and utility not hitherto found, and impossible of production elsewhere.

From such a tour of inspection and from the examination of such examples of the metal-worker's art, the householder returns to his rapidly completing dwelling with a renewed interest, filled with enthusiasm over the gems of art metal which have been spread before him; and the tasteful and beautiful appearance of the house, whose owner has completed it with such an appreciation of the possibilities of art metal work, will bear witness to the success which has attended the modern union of the Artist and the Artisan.

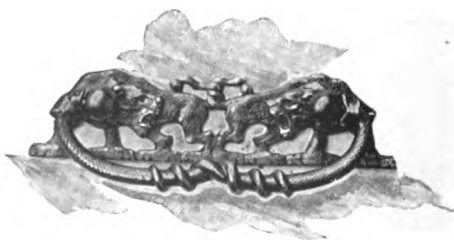

## Section 4.

### A Bit of History.



LINUS YALE, JR.,  
Inventor of Yale Lock.  
Died, 1868.

THESE are events in the history of the Mechanic Arts which are as epoch making as the achievements of soldiers or politicians in the history of a nation, and a bit of such history, relating to one of the industrial arts, is here briefly recorded.

Linus Yale, Jr., whose early ancestors were of the same family as the founders of Yale University, was born April 4th, 1821, at Salisbury, Herkimer County, N.

Y., and, at an early age, began his career as a portrait painter, thus giving rein to his strongly marked artistic proclivities.

From his father, however, who was an inventor and maker of Bank Locks, he inherited mechanical tastes and aptitudes which proved to be even stronger than those which led him first to choose the vocation of an artist, and ultimately he turned his thoughts and work into the field of applied mechanics.

His earlier efforts in this field related almost exclusively to Bank safes and locks, and were so original and successful that he came to be recognized as the leading American expert and authority in these matters. As such he was employed, as consulting engineer, by many of the banks and bankers of that day, to design their more important safes and vaults, and to provide the locks needed in connection therewith. Of these he invented many, of diverse types and of most ingenious and complicated construction.

The combination lock, as now used, was then unknown, and all of Mr. Yale's earlier inventions related to locks operated by keys, but great security was obtained by making the "bit" of the key changeable at will and also detachable from the handle, so that, as the latter was rotated in the lock, the former was detached and carried away from the key-hole to a remote part of the lock and there brought into contact with the tumblers to set them in position to permit the bolt to move, the continued rotation of the key handle then operating the bolt and returning the "bit" to the key-hole for removal. The famous "lock controversy" which arose in England, during the World's Fair of 1851, when the American, Hobbs, succeeded in picking the best English bank locks, had its aftermath in similar contests between American bank lock makers. Being drawn into this, Mr. Yale first discovered how to pick the then celebrated Day & Newell "Parautoptic Bank Lock" (known in England as the "Hobbs" lock), but soon afterwards discovered also how to pick his own best bank lock, the "Double Treasury" lock, and ended by demonstrating that any lock having a key-hole could successfully be attacked by one having the necessary skill and implements.

Ultimately Mr. Yale turned his attention to the combination, or "dial" lock, which, in crude forms, had been known for centuries, and brought it to such perfection that, before his death, it had displaced nearly all other locks for bank use, and had substantially obtained what has since been demonstrated to be its final form. Shortly after his death a method was discovered whereby the best dial locks, as then made, could also be picked, but improvements in certain details were speedily devised which completely remedied this weakness, and these as now made, are proof against picking by any methods discovered.

In the thirty-five years which have since elapsed the "dial" lock has been in universal use in America for safes and vaults, but although produced in many forms and by many makers it retains to-day the essential characteristics given it by Linus Yale, Jr.

In 1860 to 1864 Mr. Yale made and perfected what subsequently proved to be his most important invention, and the one which was destined to give his name a permanent place in the roster of American inventors. This was the key lock now known throughout the world as the Yale Lock, and with which the public is so familiar as to render it a difficult task effectively to set forth the wide departure from all previous standards which it constituted, and the radical character of the improvements which it embodied. The United States patents covering this invention were issued to Mr. Yale on January 29, 1861 and June 27, 1865.

Prior to the invention of the Yale Lock the round key was in universal use, its size usually being proportionate to the size of the lock, and, of necessity, its length being proportionate to the thickness of the door. The weight and bulk of a bunch of keys of that day can hardly now be realized. Moreover, the locks themselves were usually of crude and rather bulky form, of indifferent security and of inferior workmanship. Many of them were imported, from England or Germany, and even the old "stock-lock," with wooden frame and sheet iron working parts, was still largely used in certain sections of the country.

Mr. Yale's inventions and improvements, which since have completely revolutionized the art of lock-making in America, and contributed greatly to place it in the position it occupies far in advance of that of all other countries, consisted of the following, viz.:



1. In removing the key-mechanism of the lock from the case which contains the bolt, and in enclosing it in a separate "cylinder," inserted from the face of the door and permanently connected with the lock case behind.

2. In combining the ancient Egyptian "pin-tumblers" with a revolving "plug" containing the key-way, thus obtaining with great convenience and moderate cost, greater security and greater capacity for key changes than any other system.

3. In combining, with the revolving "plug," a *flat key*, of convenient form and of uniform size for all sizes and kinds of locks, in place of the round key previously in universal use.

4. In the adoption of a standard of design and workmanship for key locks for general use equal to that previously employed only in the case of bank locks.

5. In resorting to the use of high-class machine tools to obtain the higher standard of workmanship thus established.

6. Finally, in consulting the convenience of buyers by packing each lock in a paper box, complete with all necessary trimmings and screws (instead of merely wrapping it, separately from its related trim, in paper, as was then and for a long time afterwards, the general rule of all other lock-makers) thus initiating the practice of packing locks complete in "Sets," which is now almost universal in the trade in the United States.

The final result was a radically new type of lock, of far higher security and mechanical excellence than had ever before been made, provided with a key of the smallest and neatest form, and susceptible of production by special machinery at a cost which has made it available for general use, especially whenever security is desired.

At this period Mr. Yale was operating a small factory at Shelburne Falls, Mass., the chief product of which was bank locks, although the manufacture of the flat keyed cylinder lock,

with pin-tumblers, had also been commenced in a small way, and, in addition was acting frequently as consulting expert in safe and vault construction. In the summer of 1868, Mr. Yale, who was thus engaged, and Mr. Henry R. Towne, then of Philadelphia, Pa., a much younger man, who had received a thorough training as a mechanical engineer and was seeking an opportunity of forming a permanent business connection, were introduced to each other by a mutual friend, with the result, after some months of negotiation, that a partnership was formed between them under which Mr. Yale agreed to contribute his existing business, patents and inventive skill, and Mr. Towne agreed to provide increased capital and to organize and manage the manufacturing department. It may be noted here that although Mr. Yale's business at that time related chiefly to the making of bank locks, Mr. Towne was attracted to it by the conviction he then formed that the newly-invented "Cylinder" lock contained the germ of a business of far larger dimensions and one which, if properly exploited, could be developed into a large industry.

By mutual consent the partnership thus arranged was organized, in October 1868, in a corporate form, under the name of The Yale Lock Manufacturing Company, and was located at Stamford, Conn., thirty-four miles from the city of New York, this point being carefully selected as combining the advantages of the skilled-labor market of New England with close proximity to the commercial metropolis of the country. A suitable site having been purchased, Mr. Towne went to Stamford to design and erect the modest factory building which was proposed, Mr. Yale continuing to conduct the existing business at Shelburne Falls pending its removal to the new location.

On December 25th, 1868, Mr. Yale, who had unexpectedly been detained in consultation over the plans for the vaults of the

Equitable Building, then under construction, died suddenly of heart disease, (aged only 47 years) in the city of New York, leaving to the young enterprise, still in embryo, the heritage of his brilliant inventions, the latest and, as it has ultimately proved, by far the most important, of which was destined, through the world-wide popularity of the Yale Lock, to make his name a household word.

The subsequent history of the enterprise, whose infancy was thus clouded by the shadow of a great sorrow, is told in Section 7. It need only be added here that in 1869 Mr. Towne succeeded to the Presidency of the Company, and has since controlled its policy and directed its affairs. In 1882 it obtained a special charter from the state, and in 1883, because the original name had become inappropriate in view of the greatly enlarged and diversified line of products, the present corporate title, comprising the names of the two founders, was adopted, namely, The Yale & Towne Manufacturing Company.

## Section 5.

---

### The Yale Lock.



Yale Cylinder.

AS explained in the preceding section, the Yale Lock takes its name from its inventor, Linus Yale, Jr., whereas the numerous reproductions of its earlier forms which, since the expiration of the original patents, other manufacturers have put on the market to compete with it, have modestly been named after

one or another of the leading American universities.

Granting that "imitation is the sincerest form of flattery" the many imitations of the Yale Lock with which the market is supplied constitute the highest tribute to the unique character, excellence and popularity of the original.

As explained in Section 4, the first and most important element of the Yale Lock is the Cylinder, a front elevation of which is shown herewith and sectional views by Figs. 1, 2 and 3 on next page. It consists of a shell, or case, enclosing a revolving "plug" and containing a series of chambers to receive the "pin-tumblers" with their complementary "drivers" and springs. Extending longitudinally through the plug is the "key-way," and attached to its inner or rear end is the "cam" which, when the plug is rotated, engages with and operates the bolt of the lock.

Each "pin-chamber" is formed partly in the cylinder and partly in the plug, and each contains at its bottom a "pin" (on which the key acts), above this another pin, called the "driver," and above the latter a spring. Normally the several

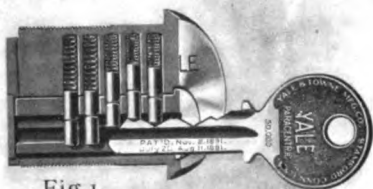

Fig. 1

FIG. 1. Cylinder with key partly inserted, illustrating the action of the key upon the tumblers.



Fig. 2

FIG. 2. Cylinder with key inserted whose bittings do not correspond with the tumblers and which, therefore, will not actuate the lock.



Fig. 3

FIG. 3. Cylinder with key fully inserted, showing operation of cam at rear, which actuates the bolt mechanism.

The Cylinder of a Yale Lock,  
Illustrating the Yale Pin-Tumbler Mechanism.

pins rest at the bottom of their respective pin-chambers, which latter intersect the key-way but do not extend quite to its lower limit. In this condition the plug is barred against rotation by the "drivers," each of which rests partly in the plug and partly in the cylinder, as seen in Figs. 2 and 3.

When a key is inserted its point passes under the pins, successively, and raises them so that they rest on top of the key. The insertion of the true key lifts each pin to a point such that the

joint between it and its "driver" corresponds exactly with the joint between the plug and the cylinder. The plug is now free to rotate within the cylinder (see Fig. 3), the *pins* traveling with the plug and the drivers remaining stationary in their respective chambers. If any but the true key be inserted, however (see Fig. 2), the pins will not be lifted to the proper points, and the plug will still be barred against rotation. As the number of the pin-tumblers is usually five, and as a variation of *one-fiftieth* of an inch from the proper height will cause any tumbler effectively to prevent rotation of the plug, it will be seen that the Yale Lock possesses a high order of security and a vast capacity for key-changes or "combinations."

The invention of the rotating "plug," with its contained "pin-tumblers," carried with it and made possible the employment of a flat but rotative key. In designing this Mr. Yale adopted the *trefoil* form for the bow or handle of the key, his original form of key being shown by Fig. 4, and for many years this peculiar design was used only with the Yale Lock, and thus became generally identified with it, so that, in time, *every lock* with a flat key, especially if the bow of the key had the trefoil shape, was popularly supposed to be a Yale Lock, although a vast number of cheap and insecure locks, not of the "cylinder" type, having keys of flat metal and with trefoil-shaped bows, were made and sold. Unfortunately, this error still persists, being often encouraged by unscrupulous dealers, and thousands of bogus locks are palmed off annually as genuine Yale Locks on customers who are too little informed, or too careless, to detect the fraud by noting the absence from the goods of the name and trade-mark of the sole makers of the genuine Yale Lock, The Yale & Towne Manufacturing Company.

As the popularity of the Yale Lock grew and the demand for it increased, the experts of the Company, finding that the

original construction, although affording great capacity for key changes, permitted the lock easily to be attacked by proper picking tools in the hands of an expert, devised and adopted a radical



Original Yale Key.  
Fig. 4.

improvement. This consisted in corrugating the blade of the key (see Fig. 5), thereby making it stronger and far more difficult to duplicate, and in forming the sides of the key-way with reverse corrugations, conforming to and inter-

locking with, those of the key. Several very marked advantages resulted from this improvement. It prevented the tilting of the key in the cylinder, which had been a fault with the flat key; it greatly increased the resistance of the lock to picking; it added further security by making it far more difficult to obtain duplicate keys illicitly; and, finally, by beginning a new series of locks, with a key of distinctly different form from the key of the original series, it precluded all possibility of locks of one series being passed by keys belonging to locks of the other series, a most desirable result in view of the vast number of Yale Locks with flat keys which were then in use.

The corrugations of the key just described approach, *but do not pass*, the axial line of the key-way, as will be seen by cut on page 77, and it was found that, by using picking tools of great delicacy, it was still possible, although difficult, for an expert to pick the lock. A long series of experiments was then undertaken which resulted in the development and the adoption, about 1892, of the type of key now used with all of the genuine Yale Locks. This great improvement, which is the culmination of the long series of brilliant inventions embodied in the Yale Lock, embodies a distinctly new principle, to designate which the name "Paracentric" was coined and adopted. The Paracentric principle, (see page 77) consists in constructing

the key-way with continuous longitudinal barriers (in planes perpendicular to the motion of the pin-tumblers), projecting from opposite sides of the key-way *past its centre, or axial line*, and interlocking so deeply as practically to preclude the use of picking instruments to operate vertically on the tumblers. The result is the *greatest security* possessed by any key-lock adapted to practical use. The Paracentric key must necessarily coincide accurately with the cross-section of its *key-way*. As its form is patented, and it can only be produced by expensive special machinery, of great accuracy, it affords the highest attainable degree of protection against the illicit duplication of keys, and, as in the case of the Corrugated key, it marks the commencement of a new series of locks, the keys of which are non-interchangeable with the locks and keys of either of the preceding series.



Fig. 5.  
Yale Corrugated Key.

The illustrations on Page 77 show the several forms of key-way referred to in the foregoing description, and also those commonly used in other "cylinder locks," made in imitation of the Yale Lock, and simulating the "Paracentric" in *appearance*, but not in *security*. These latter also have projections or "ribs" on one or both sides of the key-way (in some cases, however, only extending a short distance from its front end), but as the Paracentric patents forbid their projection beyond the centre line, they offer small obstruction to the use of picking tools, and afford little more security than the original lock with flat key. Their characteristics can readily be detected by examining closely the form of the key-way of any lock of the Yale type in which they are used.

The impression prevails quite generally that the Yale Lock cannot be picked, but this belief is contrary to the fact. *No lock*



with a key-hole has ever been made which is unpickable. Mr. Yale demonstrated this by devising instruments with which he picked the most elaborate bank locks then in use (about 1860), first the celebrated Hobbs' lock, and later his own still more intricate "Treasury" Lock, and it was the discovery of this fact which caused him to abandon the use of locks with key-holes for



Fig. 6.

Yale Paracentric Key (Obverse).



Fig. 7.

Yale Paracentric Key (Reverse).

Bank protection and to develop and perfect the combination or "dial" lock. All that its makers claim for the Yale Lock is that, as now made, it is more secure and more difficult to pick than any other in use, and that the operation of picking it is so difficult, and requires such expert knowledge, skill and tools, as to make it absolutely secure against any attack to which practically it is exposed, this statement being justified by an experience of twenty-five years, and by the record of many millions of Yale Locks in use.

Another popular fallacy consists in supposing that "no two Yale Locks have keys alike." Obviously the number of variations or "key-changes" which are possible with any given form of key is definitely limited by the physical conditions. As a matter of fact, most of the common inside door locks in use have only *four* key-changes; that is, a set of four different keys will pass all locks of a different type, or, conversely, each key will pass one out of every four locks.

Few such locks, even of the better grades, have more than twelve, or at most thirty-six, key-changes. Not long ago a house-to-house examination of the locks and keys on the front

entrance doors of the houses in *one block* in the up-town residence section of the city of New York disclosed the fact that more than ten of the locks could be passed by the same key; in other words, ten householders had free access to each other's houses!

In the case of the Yale Lock, in its standard form, the num-



Original Flat  
Key-way.



Corrugated  
Key-way.



Paracentric  
Key-way.



Single Rib  
Key-way.



Double Rib  
Key-way.

GENUINE YALE LOCKS.

IMITATIONS.

ber of key-changes theoretically possible is 100,000, but practically this is reduced, by throwing out keys of undesirable form or those too nearly similar, to 27,000. The changes or "bittings" thus selected for use are recorded in printed lists, and the latter are carefully followed in manipulating the machines which produce the keys, so that the *entire series* is used before any of the changes are repeated, but it is obvious that there is a chance, in the ratio of 1 to 27,000, that the keys of two Yale Locks may interchange. The difference between this ratio and the ratio of 1 to 4, 12, 24 or possibly 36, existing in common locks, is a fair measure of the vastly greater security of the Yale Lock against accidental interchangeability of keys.

Each of the key-changes is numbered consecutively on the printed lists just referred to above, from No. 1 upward, and, for convenience in manufacture, the keys are numbered correspondingly. Hence it follows that it is practicable to furnish duplicate keys *by number*, but the invariable rule has been, from the outset, not to do this but to require, *in all cases*, that one of the original keys (or else the lock itself, or its cylinder) must accompany every order for duplicate keys, in evidence of the right of

the party giving the order to have the key or keys called for. This policy is regarded as of *vital importance* to the security and protection of all users of the Yale Lock, and will permanently be maintained. The contrary policy, pursued by some other manufacturers, of furnishing duplicate keys *by numbers*, makes it feasible for any evil-disposed person to obtain keys to locks belonging to another by ordering them, by number, from the maker, providing only such numbers can be ascertained in any way, a thing usually not difficult of accomplishment. This highly dangerous practice tends seriously to impair the value and reliability of locks made by the manufacturers who adhere to it.

It has been mentioned above that Mr. Yale had adopted the *trefoil*, or clover leaf, bow for his original lock, and that for many years it was associated exclusively with the Yale Lock and thus became accepted as a mark of identification. Ultimately, however, other lock makers copied the trefoil key-bow, presumably to promote the sale of their goods by misleading purchaser of them.

Desiring to maintain the individuality which has always characterized every detail of the Yale Lock, its makers have recently discarded the trefoil bow in connection with the Paracentric Locks, substituting therefor the new design shown by Figs, 6 and 7, on page 76, which, in a bow of round form, embodies the Company's well-known trefoil trade mark, although continuing to use the trefoil bow for locks of other types.



## Section 6.

### Story of an American Industry.\*



Stamford Factory, 1873.

THE Yale & Towne Manufacturing Company came into existence in October, 1868, as explained in Section 4, at which time a site was purchased at Stamford, Connecticut, 34 miles from the

City of New York, and the erection of a small building begun. That building, with some additions made in 1873, is shown by the accompanying illustration.

In this building the business was started, in March, 1869, with about thirty employees, a salesroom being established simultaneously at No. 1 Barclay Street, New York. At that time Bank Locks formed the principal product, the remainder consisting of the then new and little-known pin-tumbler lock, now universally known as the "Yale Lock," of which only seven varieties had then been designed and made, viz: a store door lock, a rim and a mortise night latch, a cupboard, a chest, a desk and a drawer lock.

The enlargement of this line, and the creation of a market for it, were from the outset the chief objects of the management. Among the additions of the first few years were safe deposit locks, several forms of mortise locks, and a front door lock, the latter embodying the novel feature of operating both bolts by the same key and through a single key-hole. Just previous to his death Mr. Yale had designed a lock box, with

\* The insertion of this article is due to the fact that so much friendly interest has been shown in previous publications relating to its subject-matter as seemingly to justify its reproduction here in a more complete and connected form.

pin-tumbler lock, for the post office in Boston, Mass., and this system was now successfully developed, the rapid adoption of the Yale Lock Box in post offices in all parts of the country helping greatly to call public attention to the merits of the Yale Lock, with its diminutive and then novel key. Success in this field led shortly to the designing and building of complete post office "Equipments," including the necessary woodwork, and the industry thus initiated has since constituted one of the important departments of the business. During these early years, also, the line of Bank Locks was entirely remodeled and much enlarged, and the growth of the business was such that, by 1872 the number of employees had increased to about 150.

In 1873 the first decisive step was taken toward broadening the company's operations by the purchase of the good will, business, patterns and tools of another small manufacturing concern producing a line of *bronze hardware*, and the company thus entered a field in which it was destined later to achieve one of its most notable successes, and to become largely the creator, and concededly the leader, of a new and important industry.

In 1875 another line was added, but one extraneous to Builders' Hardware. This was the Weston Differential Pulley Block, a portable hoisting device of very original and useful construction, which has since gone into world-wide use. An exclusive license under the American patents of Thos. A. Weston was obtained, and their validity established by successful litigation, four infringing competitors were bought out, and a control of the business established which was complete during the life of the original patent, and has since been practically effective, this department, thus becoming an important and permanent feature in the Company's business. As an outcome of this undertaking the Company was led, shortly afterwards, to embark in the business of designing and building cranes, of all

kinds and sizes. In this field of engineering it was distinctly a pioneer, being the first to recognize that, in America as in Europe, cranes would surely become an important element of machine equipment, and was the first to organize for their production. For this purpose a special engineering staff was organized, a large building erected and equipped with the proper machinery, and the business thoroughly established on a large scale, the value of its product, while continued, exceeding \$1,000,000. This product, however, was wholly distinct from those of the other departments, and its heavy character, together with the fact that the chief market for it was found in the Central and Western States, made Stamford an unsuitable place of manufacture, and led ultimately to the decision to dispose of the business. Accordingly it was sold, in 1894, to The Brown Hoisting Machinery Co., of Cleveland, Ohio, by whom it is now carried on, the Chain Block business, however, still being retained at Stamford, and having been largely developed.

In 1882 another engineering enterprise was undertaken, based on a series of patents granted to A. H. Emery, C. E., and relating to a new and highly organized system of testing-machines and heavy scales, possessing greater accuracy than any previous machines for like purposes. In this case, also, Stamford was found to be unsuitable in location for a heavy engineering product, extraneous to its surroundings, and in 1887 this business was sold to William Sellers & Co., of Philadelphia, Pa., by whom it is still continued.

The Crane and Testing-machine Departments, both involving engineering work of large and heavy construction, thus being eliminated, the efforts of the management were concentrated on the earlier and more important lines of product, the growth of which has since fully occupied its abilities and resources.

Resuming the narrative of these, it may be mentioned that

in 1876, in response to the demand created by the occurrence of numerous robberies of banks, in which officials, under torture or threat of death, were compelled to disclose the combinations of locks under their control, the Yale Time Lock was invented and put on the market, its action being dependent on fine chronometer movements, and not controllable from the exterior of the safe to which it is applied. At first bankers showed great timidity in adopting a device which depended on clockwork to release the heavy doors of burglar-proof safes and vaults, but this natural hesitancy soon disappeared as experience demonstrated that the new Bank Lock not only gave the desired protection but also was thoroughly reliable in action, and a Time Lock is now regarded as an indispensable element in the security of every American banker's safe or vault. In evidence of this it may be mentioned that more than six thousand Yale Time Locks are now in daily use, chiefly in the United States, but some also in other countries.

In 1878 the position of the Company was strengthened by the purchase of two smaller competitors (The United States Lock Co. and the American Lock Co.) both making lines of locks which had become somewhat competitive, and at about this time it began the production of padlocks, of which it now manufactures a very extensive line, constituting an important department of the business. By this the number of employees had increased to about 300. Branch offices had already been established in Philadelphia and Boston, and one was opened in Chicago in 1880. Additions to the plant at Stamford were made almost annually, as the business steadily grew in dimensions, those of 1881 and 1883 being exceptionally important, and the machine equipment was constantly improved by the addition of machine tools of the latest and best construction, many of them from special designs furnished by the Company.

About 1882 began the demand for a new and distinctly higher grade of Ornamental Hardware, conforming intelligently to traditional schools and based on the accepted rules of ornament, the rise and progress of which has already been narrated in Sections 1 and 2, to which the Company responded with such promptness, efficiency and enthusiasm as to justify the statement that it led, rather than followed, the movement. It sought and obtained the cooperation of leading architects, and, thus aided, brought out in rapid succession a series of designs which were a revelation of the possibilities of this long-neglected field of applied art, and many of which are still in active demand. For the proper exploitation of this work it organized an Art Department, under trained designers, with draughtsmen, modelers, chasers and every possible facility for fine metal-working, including a chemical laboratory and, later, a photographic establishment.

At that period nearly all fine hardware was made of bronze, cast iron being rejected as an inferior and unsuitable material. Holding a contrary view, the Company sought to restore iron to its historical position as one of the noble metals, and one eminently suitable for purposes of decoration. In this effort it secured control, for such purposes, of a then recent invention by two Englishmen, Messrs. Bower and Barff, for treating iron so as to make it rustless; and a little later of an American invention, by the late R. A. Tilghman, known as the "sand blast," whereby it became possible to produce a new and beautiful finish on metallic surfaces. Both of these processes are now public property and are in general use, but the Company expended much time, effort and money in adapting them to these special uses, and can justly claim to have discovered their availability in this field, and to have established their popularity. It has an equal claim to having been the pioneer, and for several years the only worker, in the field of high class artistic hardware, as the



term is now understood, and to this day its long series of designs, in fine hardware of every kind, holds concededly the leadership over all competitors, not only in priority of origin but in artistic character, extent and high standard of execution. The importance and activity of this department have increased steadily from year to year and are greater now than ever before.

In 1891, although the number of employees had then increased to over 900, the Company made preparations to add another product to its already large business. This consisted of a complete line of Cabinet and Trunk Locks; that is of every kind and size of lock required by furniture manufacturers and trunk makers, as it had for some time been making every kind of lock required by safe makers. The line of goods thus involved is a very extensive one, and the preparations for its complete production occupied several years.

Prior to 1894 the Company's line of Builders' Hardware, including locks, comprised only the finer and more expensive grades, its customers drawing their necessary supplies of the commoner and cheaper goods from other manufacturers who made the latter but not the former grades. It had become obvious, however, that this division of the business was not permanent, and that competitors were not content to make only the inferior grades of goods but were already beginning to follow the Company's lead by undertaking to produce fine goods also, in many cases patterning them closely upon its models and style, although rarely attaining to its high standard of quality. In view of this change in trade conditions it decided to further extend and complete its own line by arranging to produce all of the cheaper varieties of locks and hardware demanded by the trade, and thus to be able to supply its customers with *everything* required in the line of Builders' Hardware.

This purpose was effected in 1894, by the purchase of the

entire property, good-will and business of the Branford Lock Works, of Branford, Conn., with a capacity for the employment of over 500 persons. The Branford line was one of the oldest, best known, and most extensive in the trade, and embraced a complete assortment of Builders' Locks and Hardware of the cheap and medium grades. Recognizing that the demand for these goods is not only very large, but also as legitimate and permanent as that for fine goods, the Company then proceeded to remodel and improve the Branford line, intending to make it the best of its kind in the market, and to incorporate in it every improvement suggested by experience in similar products of higher grade which was consistent with the necessary condition of economy in cost. This was duly accomplished, thus merging these goods with the Company's original product and making its line of Builders' Locks and Hardware the best and most extensive in the world, embracing every grade of goods, from the cheapest which are fit for use to the finest and most expensive.

Impressed by this experience with the importance of goods of medium grade, that is of good quality and moderate cost, the Company next gave special attention to strengthening its line in this direction, bringing out many new goods of this grade. Included among these was a complete line of Builders' Locks made wholly of *Wrought metal* and designated by the trade name "Vulcan," an account of which is given elsewhere.

As explained elsewhere, the device known as a Door Check has become an important article of hardware equipment, and in 1895 the Company acquired control, by purchase from the Blount Mfg. Co., of the inventions and patents relating to the Blount Door Check, a combined door spring and check of the liquid type, which had already acquired a recognized position as the best device of its kind yet produced, the manufacture of which now constitutes one of the important departments of the business

and occupies a large building devoted exclusively to this purpose.

Having thus fully occupied its chosen field of operation the Company, in 1899, issued a new edition (No. 17) of its trade catalogue, embracing all of its various and extensive products. This is a folio volume of over 900 pages, each 9 by 12 inches, illustrating, describing and pricing the entire line, and designed for use by trade customers. The vast extent of the line is indicated by the fact that upward of 120,000 prices are quoted in this volume.



Stamford Works, 1903.

During the year 1900 it was found that further enlargements of the plant at Stamford were needed to accommodate the increasing volume of business, and it was decided, in making these, to provide accommodation also for the business theretofore carried on in the Branford plant, and thus to consolidate all manufacturing operations at one point. Plans were made accordingly, and early in 1901 contracts were placed for the erection of the pro-

posed new buildings and for the necessary machinery and other equipment. These extensive improvements are now completed, giving the Stamford Works a capacity for the employment of upward of 3,000 persons, and making them the largest and best equipped of their kind in the world. They occupy an unbroken tract of over 15 acres of land, with direct rail and salt-water connections, within the city of Stamford, closely adjacent to the railroad station, and only 34 miles from the city of New York, with hourly trains each way making the trip in fifty minutes.

## Section 7.

### Evolution in Lock Designing.

**A**MERICAN locks have always been attractive in external design, as well as excellent mechanically. As an example of development in design the accompanying illustrations may interest those who like to trace the process of



Original form, about 1867.



First modification, about 1870.

evolutions in industrial art. They show the Yale lock, in its most popular form, the Yale Rim Night Latch No. 42, known and used all over the world, in its several stages of evolution from the original to the latest design.

A similar evolution has occurred in all kinds of builders' locks and hardware, the American product of which unquestionably excels all others in external appearance as well as in mechanical excellence.



First successful effort to attain graceful lines, about 1871.



Latest design, adopted in 1879.

## Section 8.

---

### Historical.

**T**HE history of the art of the locksmith is probably as old as the history of civilization, and references to it are found in the early literature of almost every nation.

Wherever and whenever property became individualized it is reasonable to suppose that means were desired and were devised for insuring its protection and privacy, and that thereupon locks in some form, however crude, came into existence.

To summarize, even briefly, the many records of the early phases of the art which are available would carry us far afield and entirely outside of the purpose of this volume, which aims merely to record the modern development of the art in the United States and to furnish technical information relating to it which will be of interest and use to the practicing architect, and perchance to his discriminating clients, and to the builder who uses and the dealer who handles the infinitely diversified product known as Builders' Hardware.

Those who are curious on the subject are referred to the generally excellent articles to be found in the larger encyclopedias and to the sources of information therein noted, and especially to a volume entitled "A Treatise on Fire and Thief Proof Depositories and Locks and Keys" by Geo. Price, published at London in 1856.

Not wholly to pass over the subject, however, we quote from the "Art Journal" of Messrs. D. Appleton & Co., an interesting historical sketch, giving also illustrations of some old locks and keys :

“The history of labor is the history of civilization, the scale of the progress accomplished, and the foreshadow of all future improvement. In no other way can a thorough knowledge of our own civilization be acquired than by looking back at the path mankind have passed over, and by examining all the footprints they have left behind.

“It is impossible to ascribe to any certain epoch and person the invention of working in metals; it dates, however, from the prehistorical times, and all the oldest mythologies have a divinity to which it was attributed. Tubal-Cain of the Hebrews, and Vulcan of the pagans, seem to be only one myth, and the reproduction of old Hindostanic traditions.

“It is an accepted opinion that the art of the smith has its root in the right of property. As soon as the idea of *meum* and *tuum* entered the human mind, say the majority of writers, just so soon were the contrivances of this art called into requisition. We think, however, that

its origin can be traced further back to an earlier age of the world, and to another cause. It is evident that, to provide against the attacks of wild beasts, man must have secured the entrance of the cave or hut in which he dwelt by some means or other. However rude, those manifestations of man's ingenuity foreshadow the contrivances applied later on to secure property. Wood was undoubtedly the first material employed in their construction, and very likely they were at first simple wooden bars and bolts. In fact, such is even at the present day the means by which many tribes of savages fasten their doors. Wood seems to have



No. 1.



No. 2.

long filled the office of copper, brass and iron, even among civilized nations; the *basso-rilievos* of the great Temple of Karnac prove that the Egyptians used wooden locks even when they were at the height of their civilization. M. Bonomi actually found in the ruins of Nineveh a wooden lock which appears to have secured the gate of an apartment in one of the palaces of Khorsabad.

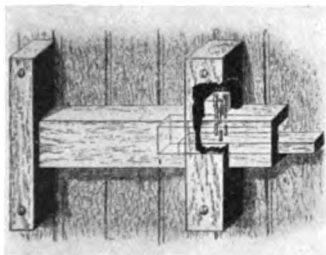

No. 3.

It is the oldest lock yet discovered. 'At the end of the chamber, just behind the first bulls,' he says,\* 'was formerly a strong gate of one leaf, which was fastened by a large *wooden lock*, like those still used in the East, of which the key is as much as a man can conveniently carry, and by a bar which is moved into a square hole in the wall. It is a key of this description that the prophet probably alludes to: 'And the key of the house of David will I lay upon his shoulder.' And it is remarkable that the word *key* (*muphta*), in this passage of Scripture, is the same in use all over the East at the present time. The key of an ordinary street door is commonly thirteen or fourteen inches long, and the key of the gate of a public building, or of a street or quarter of a town, is two feet and more in length.' Cut No. 1 shows this kind of key, and No. 2 the mode of carrying it alluded to in Isaiah, and as practiced still in the East. No. 2 in fact represents a modern merchant of Cairo carrying the keys of his magazine, as given by Mr. Price in his work on locks and keys. The iron pegs at one end of the wooden key correspond to so many holes in the wooden bar or bolt of the lock, which, when

\* Bonomi's "Ninive e i suoi Palazzi."



the door is shut, cannot be opened till the key has been inserted, and the impediments to the drawing back of the bolt removed by raising up so many pins that fall down into holes in the bar or bolt corresponding to the pegs in the key. From a letter by

W. C. Trevelyan, which appeared in the *Journal of Design and Manufactures*, for July, 1850, it appears that similar constructions are still in use in the Faroe Islands, as they have probably been for centuries.



No. 4.

“Strange as it may seem, the principle on which this Egyptian lock is founded is almost identical with that of the modern lock of the most approved construction. By what process the Egyptian smiths arrived at the conception of such ingenious mechanism is unknown; at any rate, it supposes the previous existence of simpler forms, for the law that bids man pass from the simple to the complex is the ruling law of mental development, and the more we go back toward the primitive ages of the world the slower is the improvement. Of how many centuries of patient labor was this lock the result, cannot be told. In cut No. 3, which is copied from a wooden lock lately brought to England from Alexandria, and now in the possession, we believe, of Mr. Chubb, of



No. 5.

London, we have, as nearly as can be expected, the whole secret of the modern patent locks, and we deem it not amiss to give a

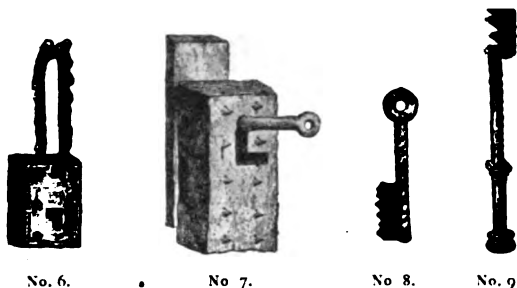

No. 6.

No. 7.

No. 8.

No. 9.

brief description of it.\* The right-hand staple is fixed in the side of the door; the cross-piece is the bolt, the projecting piece at the right is the key. Into the upper part of the staple are fitted three loose pins, which drop into three corresponding holes in the bolt, so as to fasten the door when the bolt is pushed in to its full extent. The key is a straight piece of wood having at one end several pegs, corresponding in position with the movable pins or tumblers in the lock. This key is inserted lengthwise through the slat or hole formed in the bolt, and then the pegs in the key, corresponding with the vertical holes in the bolt, into which the movable pins have dropped, lift up the pins, flush with the upper side of the bolt, and allow it to be moved backward or forward, to fasten or unfasten the lock. Now it would appear that no other key than the one made for this lock could have disengaged the bolt; because, from the movable pins being of different lengths, it follows that the pegs in the key must have been of corresponding height, and that, if any of the pegs in the key were too long or too short, they would not free the bolt.

“The Egyptians, however, appear to have at an early date

\* For all mechanical explanations that may be found in this sketch, we are indebted to the kindness of Mr. Frederic Voss.

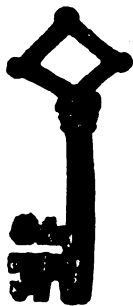

No. 10.

applied also brass and iron to the construction of locks and keys. Wilkinson, in his 'Manners and Customs of the Ancient Egyptians,' describes a key made of iron, which he found in the ruins of Thebes, and which had a shank five inches long, the handle being made by a loop at one end, while the other was turned at a right angle to form the operative part of the key, which was furnished with three teeth or points, to fit into corresponding cavities in the lock.

“We learn from Mr. Parkhurst's 'Hebrew Lexicon,' as quoted by Mr. Chubb and by Mr. Price, that certain crooked keys, having ivory or wooden handles, were used by the Hebrews and by the Greeks for the purpose of bolting or unbolting locks. Yet, before the Greeks knew anything about iron keys and locks, they fastened their doors and cabinets in a peculiar way, of which there is no record of its having ever been used by other nations. They fastened them with knots very difficult to be untied by any one but the person who had made them. In the eighth book of the 'Odyssey,' Ulysses is represented securing the rich presents of Alcinous and his queen, by a cord or rope fastened in a knot 'closed with Circean art.' This knot of Ulysses became a proverb to express an insoluble difficulty, and the Gordian knot is a proof of the estimation in which the ancients held this art, so necessary in the absence of locks.

“The locks that modern Greeks still use, particularly in the mountains, where so many of the ancient customs and traditions are preserved,



No. 11.

seem to point to another equally primitive manner of fastening doors. These were closed from inside by a bar, either of wood or of metal, attached to the door by means of leather strings or small iron chains. The keys by which these bolts were lifted up were made in the shape of hooks or sickles, either of wood or iron. So simple were these contrivances that any hook could open nearly every door; thus the Greeks had no difficulties in robbing each other. It is easily imagined that such a state of things could not last long; and the Greek ingenuity, that was never amiss, soon provided better for the security of property. The so-called Lacedæmonian lock was invented. When Pliny and Virgil speak of Theodorus of Samos as the inventor of locks and keys, it is perhaps in reference to the Lacedæmonian lock that their words possess a certain amount of historical truth. In time this specimen of fastening was improved by the insertion of the bolt in an iron frame or rim, which was permanently attached to the door by a small chain; but such a confusion is made by all the writers in describing the manner in which this lock worked, that we have been actually unable to find out what they meant.

“Keys seem not to have been reduced in size by the Greeks. Homer tells us (*‘Odyssey,’* xxi.) that Penelope, wanting to open a wardrobe, took a brass key very crooked and hafted with ivory. On this passage Eustathius, the Greek commentator of the *‘Sovereign Poet,’* remarks that this kind of key was very ancient, and different from the keys having several wards, which have been invented since, but that they were in use even in his own time (1170). They were in the shape of sickles, and, not being easily carried in the hand on account of their size and inconvenient form, they were usually carried according to the Egyptian style. Callimachus, in his hymn to Ceres, says that the goddess having assumed the form of Nicippe, the priestess,

carried a key fit to be borne on the shoulder. That keys with a kind of ringed handle were known to the Greeks, is further



No. 12.  
Hindoo Lock.

proved by a passage of Aratus. In order to give his readers an idea of the figure of the constellation Cassiopeia, he compares it to a key, and Huetius states that the constellation answers indeed to such a description, the stars to the north composing the curved part, and those to the south the handle.

“Among the nations of antiquity, lock-making made little progress in advance of what had been done by the Egyptians. Even the Romans, who excelled the other nations in iron-work, used very simple locks, which resembled those of the modern Greeks. For a long time these contrivances were not nailed to the doors, and to open them it was sufficient to insert a jack into the staple and shake it; hence Ovid wrote, ‘*Escute forte scam*’ (‘Shake the lock hard’). Varro and Nonius also speak of this kind of locks as being mere padlocks. In the excavations executed in 1853, at Pompeii, in presence of the Imperial Princess of Russia, were, however, found a number of locks and keys which are improvements on anything previously made, as will be seen in our cuts Nos. 5, 6, 7, 8 and 9. The simple construction of No. 5 announces its greater antiquity; the bolt is of brass, and was evidently intended to move up and down a staple, on the lever principle, and to close by falling in a hasp fixed in the frame of the door. No. 6 marks a step further in the art of lock-making. It is an iron padlock with a brass handle, very much corroded by age; the frame

presents some attempts at carving, and is covered by a beautiful *vert-de-gris*. No. 7 is typical of a further improvement. It is no longer a padlock—it is a real lock, nailed to the boards of the door, pieces of which are still connected with the former. The bolt inside is also of hammered iron, and so is the key; applied to this bolt is what I would call ‘the embryo of a spring,’ the oldest token we have of this accessory. This lock is ornamented outside with ten brass nails, the four at the corners passing through the lock and the boards of the door, on the other side of which they are riveted. The key shown by our illustration No. 8 bespeaks that elegance which later on was to distinguish iron-works of all kinds; human ingenuity, by this time, does not satisfy itself with making contrivances to secure property; it devises ornaments for them, and endeavors to introduce such a variety in key and lock making as to render it more difficult to open locks with any other than the proper key. This specimen of key has in fact a square hole, and the surface of its shank is inlaid with silver. The house in which these and other contrivances were found seems to have been that of a locksmith. No. 9 is a faithful facsimile of an iron jack probably used by the professional man to catch all kinds of bolts, and open doors whose keys were lost. The ornaments on the handle are of brass, and show refined workmanship. The existence of these objects seems to have been utterly ignored by all writers on the subject, as we nowhere find them mentioned, yet they are to be seen in the Imperial Museum at St. Petersburg.

“Next in antiquity come the warded locks in ordinary use. Whence these had their origin is unknown; they seem, however, to have been used by the Etruscans, as rude specimens of them have been found in the excavations opened on the sites where the cities of Luni and Populonia arose three thousand years ago. In the Etruscan Museum of Volterra, a wonderful collection very



No. 13.

little known abroad, there are some locks of this description, which seem, however, to have never fallen under the observation of writers on iron-works. Though our researches have been diligent, we have failed to find that any but a few of the most important objects belonging to this collection have ever been illustrated, and we are therefore unable to furnish engravings of the specimens mentioned above.

“The examples of Roman keys found in various parts of England, and contained in the British Museum, will amply repay examination. Some of the specimens preserved at Marlborough House are not purely Roman; as cuts Nos. 10 and 11 show, they have a national character; so to speak, they are of Celtic architecture. Though the whole of them belong to the same description of lock—the warded lock—they are distinctly different. In locking and unlocking these keys did not perform a complete revolution, and consequently they were identical with the spring locks of modern days. The Gauls, too, seem to have taken their locks from the Romans, as there is no trace of their having been acquainted with the manner of working in iron previous to the invasion of Gaul by the Romans.

No. 14.  
Mediæval Anvil & Smith.

“Puzzle-locks have not been unknown to the less civilized nations, and their antique origin is certain. There are several known by the name of Russian, Chinese, and Hindoo puzzle-locks, some of which have the forms of various animals or birds,

and they are locked and unlocked by pressing upon or moving some particular portions of their bodies. In one of the early volumes of the *Illustrated London News* the accompanying engraving (No. 12) and description of one of the Hindoo locks appeared, which was so far secure in proportion to the amount of reverence felt for the god it is supposed to represent. 'This curious lock,' says the journal quoted, 'is in the form of a bird; probably representing the Hindoo god Garuda, the carrier or bearer of Vishnu, Garuda being to Vishnu what the eagle is to Jupiter. Garuda is worshipped by the natives of Madras; and his living type, a kind of large hawk, is diligently fed by the devotees. The writer has often seen the worshippers with little baskets filled with flesh, which is thrown skillfully, a small piece at a time, into the air, while they shout 'Hari! hari!' a name of Vishnu, and the bird stoops on the wing and takes the prey. Garuda is supposed to possess human or rather divine intelligence, and is much revered. Many stories are told of his discernment and cunning; and it is probably on this account that the native artist has made his lock in the form of Garuda, a sufficient guarantee, in his notion, for its acting as a guard or detector, equal or even superior to the more mechanical and scientific inventions of the kind. We should add that in this Indian lock the key-hole is on the side, one of the wings of the bird serving as a shifting escutcheon.'

“The ravages that followed the downfall of the Roman Empire gave an unprecedented impulse to lock-making—indeed, to the art of working in iron generally. The danger of being robbed at any time was a keen spur for human ingenuity to improve the means of securing property. Painting on glass is not the only art that the Middle Ages made their own, developed and perfected to a marvelous degree; that of the smith was furthered likewise. For the security of property, locking a door became



insufficient ; doors were lined with iron plates or strengthened by iron bars, and even made of iron altogether ; locks were applied to any piece of furniture destined to contain valuables, and these, too, were either strengthened by iron network or made of iron. Though the fact has seemingly been overlooked by the historians of safe-making, iron safes began to be built as early as the fifth century of our era. Gregory of Tours, the French Herodotus, relates in his history of France that the Emperor Justinian being dead, Justin II., his successor, full of miserly fears, 'ordered his smith to construct iron coffers to keep there his thousands of gold-pieces.' Fredegonde, Queen of France, wishing to revenge herself for some insult she had suffered from her daughter Rigonthe, engaged her to take anything she chose among her mother's jewels, 'which were kept in an immense iron chest,' says the same author. 'While Rigonthe was thus bent over the open coffer, Fredegonde with unparalleled treachery caused the iron lid to fall on her daughter's head, and so she pressed on it with all her weight, that the poor girl's neck, caught between the cover and the rim of the iron box, was nearly severed from her body.'

"During the pagan ages labor had weighed on man as the penalty of a crime ; Christianity transformed it into a glory. In the early centuries of the new religion manual labor, accomplished with resignation and courage, rose up to the level of virtue. The Middle Ages made a goldsmith bishop, several smiths archbishops, and a carpenter Pope. The saints' calendar of those times is filled with names sanctified by manual labor."

KEYS OF VARIOUS PERIODS.

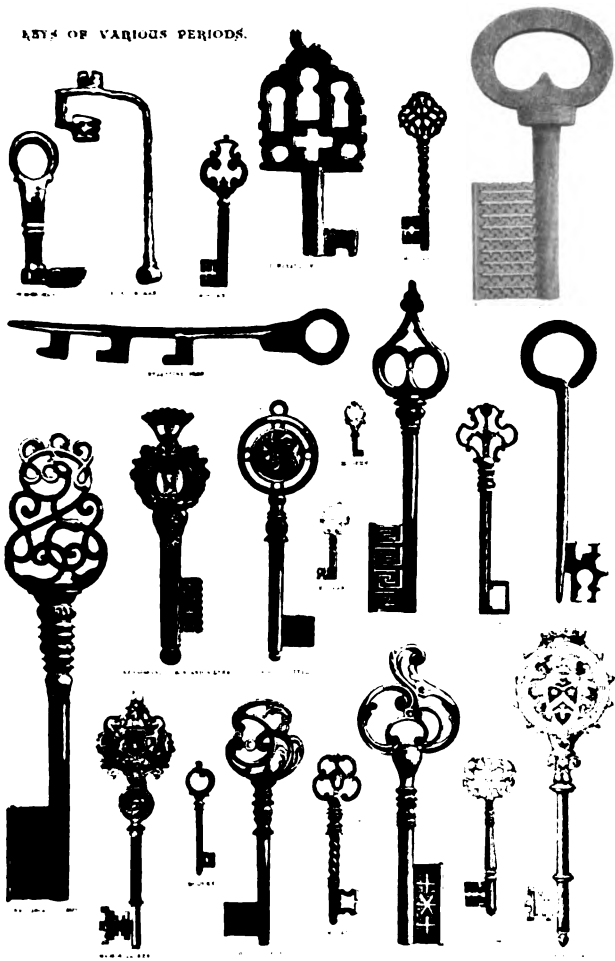

Keys of Various Periods.



BRASS LOCK AND KEY FROM A JAPANESE TOMB.



ORNAMENTAL KEY IN BRONZE, EARLY ITALIAN.



OLD PADLOCK DREDGED UP FROM THE BED OF A FLEMISH RIVER IN 1574, AND PROBABLY DATING FROM THE SPANISH OCCUPATION OF THE NETHERLANDS.

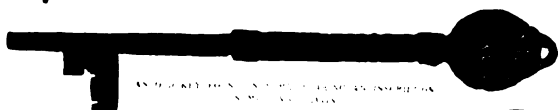

AN OLD KEY FOUND IN A TOMB IN THE MOUNTAINS OF SWITZERLAND.

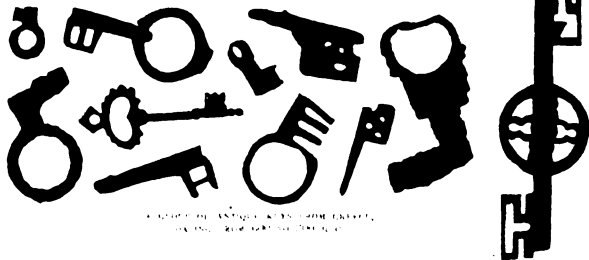

A GROUP OF ANTIQUE KEYS FROM GREAT BRITAIN, SHOWING THE VARIETY OF FORMS.

**Ancient Locks and Keys.**

## Part II.

---

### The Mechanics of Hardware.



## Part II.

### The Mechanics of Hardware.

Section.	Page
1. A Lock Primer, . . . . .	105
3. Grades of Builders' Locks, . . . . .	117
4. Master-keyed Locks, . . . . .	121
5. Wrought Metal Locks, . . . . .	127
6. Cylinder and Pin-tumbler Locks, . . . . .	137
7. Keys, . . . . .	139
8. Front Door Lock, . . . . .	142
9. Dutch Door Trim, . . . . .	145
10. Locks for Residence use, . . . . .	147
11. Hotel and Office Locks, . . . . .	151
12. Store Door Trim, . . . . .	159
13. Lock "Trim" and Lock "Sets," . . . . .	161
14. Hand and Bevel of Doors, . . . . .	163
15. Knobs and Spindles, . . . . .	168
16. Butts, . . . . .	173
17. Door Bolts, . . . . .	179
18. Sash Trim, . . . . .	181
19. Casement Trim, . . . . .	185
20. Shutter Trim, . . . . .	189
21. Transom Trim, . . . . .	193
22. Minor Fastenings, . . . . .	196
23. Double Acting Hinges, . . . . .	199
24. Door Springs, Checks and Stops, . . . . .	201
25. Hinge, Corner and Kick Plates, . . . . .	207
26. Trim for Special Conditions, . . . . .	209
27. Sliding Door Hangers, . . . . .	211
28. Pivoted Window Trim, . . . . .	214
29. Padlocks, . . . . .	215
30. Cabinet Locks, . . . . .	216
31. Trunk Locks, . . . . .	217
32. Asylum Locks, . . . . .	218
33. Prison Locks, . . . . .	219
34. Bank and Safe Locks, . . . . .	220
35. Post Office Lock Boxes, . . . . .	224

## Section I.

### A Lock Primer.

**B**ROADLY speaking a lock is a *bolt* guarded by an *obstacle* and controlled by a *key*.

The *Bolt* usually slides, but may be pivoted or rotary.

The *Key* usually rotates, but may act by sliding or pushing.

The *Obstacle* which must be overcome by the key to operate the bolt, may be of either of the following types, viz.:



Fig. 1.



Fig. 2.

Forms of Wards.



Fig. 3.

*Warded Type*, (Figs. 1, 2 and 3), in which the obstacle consists of fixed “wards” within the lock, which interfere with the movement of the key unless it has grooves or perforations coinciding with the wards;

or *Tumbler Type*, (Fig. 4), in which the obstacle consists of one or more movable “tumblers,” which prevent movement of the bolt until they are moved into a certain position



Fig 4.

Lever Tumbler.

tion by the proper key.

All locks are built up out of these elements.

The element which chiefly determines the character of a lock is the *obstacle*, that is, the type of obstruction which the key must overcome to actuate the bolt; and this in turn largely influences the form of the key.

The four types of key most commonly used are the following, viz :

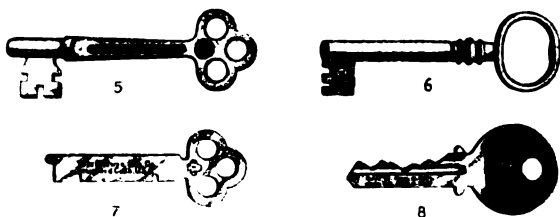

*Round Key*, (Fig 5), with solid cylindrical shank and stem, and with a wing bit.

*Barrel Key*, (Fig. 6), a round key with a tubular end, the hole in which fits over a guide-pin in the lock.

*Flat Key*, (Fig. 7), originally of the Yale type, but now commonly used (in combination with a revolving centre or disc) with locks of both the warded or lever-tumbler types.

*Cylinder Lock Key*, (*Yale type*), Fig. 8, as used in pin-tumbler locks made on the Yale system.

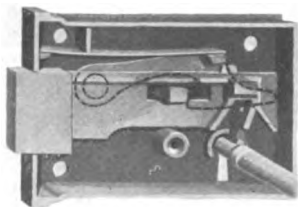
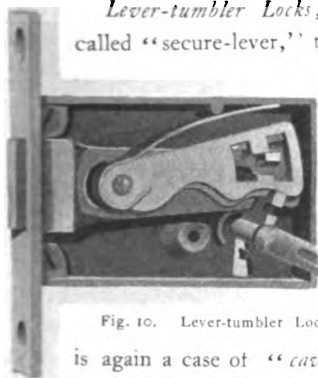

Fig. 9. Warded Lock.

The types of Locks in common use, classified by the element of the "obstacle," are as follows, viz :

*Warded Locks*; (Fig. 9), this construction is usually employed only in the cheapest grades

of locks, and, as so used, affords the minimum degree of security. As the term "warded lock" would call attention to these facts it is little used in the trade, and the rule "*caveat emptor*" applies. Most warded locks have a "back spring" or dog, the feeling of which, when using the key, resembles that of a tumbler, but which adds nothing to the security. Locks selected because cheap will usually be found to be of this type. Round, Barrel and Flat keys are all used with warded locks.



Lever-tumbler Locks; (Fig. 10), in this type, also called "secure-lever," the degree of security is measured

by the kind and number of tumblers, and covers a very wide range. A one-tumbler lock has little or no more security than a warded lock, and as attention is not often called to the fact that, although a "tumbler lock"

it has only *one* tumbler, it is again a case of "*caveat emptor*." The buyer who pays little gets little, in locks as in other things.

With two or three tumblers, however, the degree of security increases rapidly, almost in a geometrical ratio to the number of tumblers, so that such locks become suitable for a large number of uses. With Builders' Locks even of this grade, however, the number of key changes is usually limited to 12 or 24, occasionally rising to 36 and in a few cases to 72, so that careful selection is needed where greater security against interchange of keys is desired. A good three-tumbler Builders' Lock, of the lever-tumbler type, should be capable of from 200 to 500 key-changes, and such locks can always be had if called for, but of course at higher cost.



In selecting locks for any purpose the *number of changes* should always be investigated, as it affords a reliable clew to the security and quality of the lock. Round, Barrel and Flat keys are all used with lever-tumbler locks.

*Cylinder Locks (Yale type)*; this system of lock construction is fully described in Part 1, Section 5. It affords the highest degree of security and, with the five pin-tumblers usually employed, a vast number of key-changes.

Under the generic name of "cylinder" locks they are now made by many manufacturers, all of whom have copied the original prototype, the Yale lock, more or less closely, excepting, of course, the Paracentric key and other features which are still protected by patents. As little or no difference in cost exists, however, preference may safely be given to the original, rather than to any copy, however close, especially as in this way the buyer is assured of the benefit of every latest improvement.\* Flat, Grooved, Corrugated and Paracentric keys are used with cylinder locks.

All Builders' Locks, Cabinet Locks and Padlocks are based on various combinations of the foregoing elements, their other variations relating merely to size or to uses.

The forms of Builders' Locks which architects most frequently require are the following, fuller definitions of which may be found in the Glossary, viz.:

*Front Door Locks and Vestibule Latches*; for entrance doors.

*Two-Bolt Knob Locks*; for room, communicating and closet doors.

\*In this connection the following true story (even if slightly *infra dignitate*) may be permitted. In response to a demand arising from a new type of building a certain new form of Yale Lock was designed and put on the market. A mistake was made in the first lot of iron castings, but, as quick delivery was urged, time was saved by cutting out a certain "stump" (which was wrongly located) and riveting in a brass substitute in the proper position. An alert competitor promptly reproduced the lock, *in ipso forma*, patch included! No apparent reason for the patch appeared, but being in a Yale Lock, it was copied, thus repeating the incident of the traditional Chinese tailor, who being commissioned to duplicate a European coat did it so conscientiously as to include all the patches.

*Three-Bolt Knob Locks*; for bedroom and bath room doors.

*Sliding Door Locks*; for all kinds of sliding doors.

*Knob Latches*; where a knob action only is required.

*Dead Locks*; where a key action only is required.

*Night Latches*; where a spring lock, with key, is required.

*Hotel Locks*; for bedroom doors, in series controlled by a master-key.

*Office Locks*; for office doors, in series controlled by a master-key.

*Store Door Locks*; for entrance doors of stores, etc.

Each of these is made in many sizes and styles, with various kinds of keys and in many qualities, which latter are closely indicated by the price; so that specifications which do not specify by catalogue number, or by a very complete description, leave an open door for the use of the cheapest lock of the general kind called for.

To secure the best result for a given expenditure either the locks should be omitted from specifications and selected by the architect or owner, or, if included, should be carefully selected and then specified exactly, preferably by the maker's name and numbers. Full information for this purpose is given in Part IX.

To select the proper lock for any door the latter should first correctly be classified, whereupon the available locks can then be found under the several designating names above indicated.

The degree of security required is determined by the purpose for which the lock is intended, and can be obtained by selecting a lock having the proper type of mechanism and key, according to the indications given in this section and elsewhere. It should be borne in mind, however, that, with locks as with other material, low price usually means low grade or quality, and that where medium or high quality is wanted locks of corresponding prices should be selected. Cheap locks have many legitimate

uses, but these rarely extend to work worthy of the professional architect, and the latter must guard against their intrusion where not wanted.

In selecting locks of higher grade and higher cost, however, he has equal assurance that he will obtain as good or *better*, value for his expenditure, competitive conditions having long since brought prices for locks of all grades to a basis which corresponds very closely to their relative cost of production. Therefore, for ordinary work the medium grades are usually the cheapest which should be considered, while for high class residence, commercial and public work the best are none too good, and their cost rarely, if ever, seriously greater.

In conclusion a few words may not be out of place as to new inventions. Few self-respecting professional "inventors" have felt their mission to be fulfilled until they have "invented" a lock of some kind. Apparently there is a fascination in the subject which they cannot resist, however complete their ignorance of the past achievements and present development of the art, and so each incontinently proceeds to "invent" things which, while new to his untutored mind, are usually already well-known, occasionally in successful use, but more frequently long since consigned to the limbo of useless and discarded schemes.

If the text of the "primer" has served its intended purpose it has shown that the essential elements of a lock are few in number and simple in kind. Practical success lies in adapting them skillfully to the intended purpose. In lock-making, as in other mechanic arts, this can usually best be done by those who possess the proper training, the best facilities and the broadest experience, and who have devoted their undivided attention and skill to the designing and making of *good locks*.

## Section 2.

---

### Lock Picking.

SO much misconception on this subject exists as to call for its discussion here. As stated elsewhere, no lock *having a key-hole* has ever been made or invented which is absolutely proof against picking, nor is it probable that one ever will or can be made.

The London International Exhibition of 1851 was the scene of the greatest lock picking contest which ever occurred, and its interesting story is told from the English side by George Price,\* and from the American side by its champion, A. C. Hobbs.† The latter, an American with an extraordinary sense of touch, had gone to London as the representative of a then celebrated bank lock, now long forgotten, and was led to attempt the picking of the leading English bank lock of that day by the reward which had long been offered to anyone who could do so.

He succeeded in this, and great public interest was aroused by the controversy which ensued, heightened by the international rivalry involved, even prominent bankers taking part and sides. Hobbs remained the victor, and subsequently established a business in London, which still flourishes under different ownership, based on a well-made lever-tumbler lock for general use (but containing no new features of special merit) which as the "Hobbs Lock," at once became popular because of the renown attaching to his name in consequence of the lock picking controversy of 1851 above referred to. Thus it happens that in

\* A Treatise on Fire and Thief-Proof Depositories and Locks and Keys. By George Price. London, 1856. Pages 532 to 582.

† In Transactions of The American Society of Mechanical Engineers, Vol. VI, Page 233.

England as well as in the United States the name of an American inventor is associated with the best known and most popular lock, that of Hobbs in the former and that of Yale in the latter.

Now the English locks picked by Hobbs (whom the author had the pleasure of knowing well in his latter years, which were spent in America and devoted to the management of a large works making ammunition for small arms) were Bank Locks, operated, as all such locks then were, by keys, but of intricate and expensive construction.

The Day & Newell so-called "parautoptic" lock, with which Mr. Hobbs had gone to England, a leading American bank lock, was also a key lock, and Mr. Yale, prompted by the London developments to study the subject, demonstrated soon afterwards that he could pick it, and thus shattered another reputation. But he also discovered that the instrument which he invented for this purpose, a micrometer, enabled him to pick his own best bank locks, all of which were key locks but exceedingly intricate, some of them costing as much as \$300. It was this fact which led him finally to discard all forms of locks with key holes for bank use, and to turn his attention to the combination or "dial" lock. In the form in which this stood at the time of his death, in 1868, it was supposed to be unpickable, but in the following year it was demonstrated to be pickable by Mr. James Sargent, maker of a competing bank lock of the "dial" type, whose own lock, however, was also shown to be vulnerable a little later.

Out of this recurrence of the "lock controversy" came a fuller knowledge and a perfecting of details which led up to the present type of Dial Lock, which, in its better forms, is absolutely unpickable by any means now known or which it is probable can ever be devised.

The great publicity given to the "lock controversy" in

England, and, in lesser degree, to the picking of the earlier forms of Dial Locks in America, stimulated public interest in locks of all kinds, and led to great activity in the United States in the invention of new varieties of Key Locks, especially in the period from 1870 to 1880. Most of these inventions had little or no merit, and soon disappeared. A few had merit, and for a time had some sale, but most of the good ones were of complicated construction, and if well made were expensive, or if cheaply made were unsatisfactory. The chief object sought in all was security against picking. As experience accumulated it became evident that practical security does not depend necessarily upon intricacy of construction, but can be obtained, in degree amply sufficient for all ordinary uses, by simpler, and therefore better, methods of design and construction. The final outcome has been the rejection by the public of "freak" locks of all kinds, and the acceptance of the three standard types explained elsewhere, viz: the "warded," the "lever-tumbler" and the "pin-tumbler."

Locks of the "pin-tumbler" type, that is those constructed on the "Yale" system, are now made by many manufacturers, all conforming in detail more or less closely to the methods of design and construction developed by the makers of the Yale Lock, but omitting, of course, recent improvements introduced by the latter and covered by patents still in force. Where departures from the original model have been made they have usually been intended either to cheapen the construction or to embody some novelty; in either case they have failed to constitute any improvement on the original, and the latter still represents the best and latest development of the art.

This somewhat long story has been told to emphasize the fact that no lock exists, operated by a key through a key-hole, which cannot be picked by the modern lock expert if given the neces-

sary time and tools, and that no such lock can truthfully be claimed to be pick-proof. But this statement implies no change of conditions and need cause no feeling of insecurity. On the contrary, users of locks are offered better security to-day than ever before, due above all to the advent of the Yale Lock and to its influence in raising the standard of design and workmanship in locks of all other grades.

Practically security is a relative term, and while no key lock is absolutely pick-proof some of them are so difficult to pick as to defy attack except by an expert, aided by all favoring conditions, and many others have sufficient security for the purposes for which they are used.

On the other hand, vast quantities of cheap locks are made which have such slight security as to offer little or no resistance to attack by the simplest tools, a few skeleton keys sufficing to open most of them, and in too many cases such locks are employed in places where security is really important, under the delusion that they furnish it. He who buys a cheap lock gets what he pays for and no more.

The method employed to pick a lock depends on its type. To pick a "warded" lock all that is required is an instrument which will clear the wards and which has an arm or bit on its end of a length which will engage with the bolt so as to move it. A pick of this kind can usually be made by simply bending a piece of stiff wire (such as telegraph wire) into a hook, a few trials sufficing to ascertain the necessary shape. Hence the insecurity of the common warded lock used on doors and on furniture. Its merit lies in its cheapness, but it should have no place where security is needed.

To pick a "lever-tumbler" the same simple instrument may be sufficient, if there is only *one* tumbler, but if the lock has several

tumblers another method and better instruments are usually necessary. In this case the method of picking consists in using one instrument to put retractive pressure on the bolt, and another to lift the several tumblers, one at a time. The application of pressure forces the "fence" or stump on the bolt against the tumblers. Practically one tumbler will always be found to bear first or harder than the others, and a delicate sense of touch will detect this difference through the picking tool, thus enabling that tumbler to be set so that its "gating" is in line with the "fence," whereupon it will hang or remain resting on the "fence" while the same operation is repeated to find the tumbler which next bears hardest, this process being continued until all of the tumblers are thus set, whereupon the pressure on the bolt will cause it to retract, the barrier to its motion having been overcome.

All "lever-tumbler" locks are susceptible to attack by this method, some being easy and others difficult to pick, according to their construction and number of tumblers. As a rule the difficulty increases rapidly with the increase in the number of tumblers. The same method is available in the case of cylinder locks, except that the pressure is applied to rotate the plug instead of to act directly on the bolt, but as such locks usually have five pin-tumblers, which are more difficult of access and are, or should be, more accurately fitted, the difficulty of picking is greatly increased and can only be overcome by an expert aided by the necessary instruments. The highest degree of security is attained by the Yale Paracentric Lock, in which the difficulties just referred to are greatly augmented (as explained in Part I, Section 5) by the interlocking barriers of the key-way which, projecting from either side beyond the axial line, so obstruct the key-way as to make the use of the picking instruments, even of the finest kind, exceedingly difficult, and rendering this lock unpickable



except by the most skillful expert equipped with special and very delicate tools. As against any attack to which it is exposed in actual use the Yale Paracentric Lock is practically pick-proof.

Safety against picking and high capacity for key-changes are the two elements which determine the degree of security which a lock affords, and both should be kept in mind when selecting locks for various uses. For some purposes a lock is needed merely to secure reasonable privacy, and in such cases high security is not called for, but for cash drawers, desks, wine closets, offices and especially for the street doors of stores, residences, etc., only locks having high security should be selected, and the difference in cost between these and those of inferior character is now so small as to leave no excuse for the use of insecure locks where the protection of person or property is the end in view.

## Section 3.

### The Grades of Builders' Locks.\*

#### COMMON GRADE.

**E**NORMOUS quantities of locks of the commoner and cheaper grades are, and always will be, made to meet the demand for such goods arising from the construction, in city and country, of buildings of the cheapest class, especially tenements and small houses, most of which, however, are built on speculation, or by direct contract with builders, and thus seldom come under the professional care of the architect. As cheapness is the controlling factor in such goods, quality diminishes accordingly, and often to the vanishing point. With locks of this class the architect has little concern, and a brief description of them will suffice.

For the cheapest work Rim locks are preferred, because requiring no "trim" except knobs, and still more, because much cheaper to apply than locks which require to be mortised into the door. They are made chiefly of cast iron, japan finish, but recently also of wrought steel, the latter usually being somewhat better, as for example in the case of the "Vulcan Jr." lock.

Such locks usually present a fair external appearance, and are worth the low prices at which sold. Their "cheapness" is chiefly internal, and is easily apparent on opening them, as should be done when making a selection. Those in which the bolts and tumblers (if any) are of brass or wrought steel should be given preference over those in which these parts are of cast iron, as the latter is more liable to break. There is considerable choice also in the styles of keys.

\*For detailed enumeration of locks of various grades see Part IX.

Cheap Mortise locks are also largely used, combined usually with the cheapest kinds of "trim," and the above remarks apply equally to them. The most objectionable are those with cast iron *fronts*, because of the liability to breakage of this part if made of a brittle material, and fronts of steel or bronze should be insisted on. The demarcation between poor and fairly good mortise locks is not well-defined, and thus it is not difficult to substitute the former for the latter when self-interest so prompts. The remedy lies in a careful selection, a definite specification and a subsequent close inspection. The difference in cost will be found so inconsiderable, however, between very poor and fairly good locks as to justify the use of those of a "medium" grade for nearly every minor purpose covered by the work of the architect.

As a final caution we repeat that an inspection of the *interior* of a very cheap lock is the best, and usually the only safe way of ascertaining its true character and its fitness for the purpose in view. Cast iron keys, although largely used, should be rejected.

#### MEDIUM GRADE.

This group has been greatly improved and extended in recent years, and now includes locks excellently adapted to a large range of uses within the field of architectural practice, especially in the field of small residence work. In the latter work Rim locks of the better grade are sometimes used for attic, basement and closet doors, but otherwise Mortise locks are the rule. These should be of the *lever-tumbler* type, with at least *three* tumblers if for use on entrance doors, or other places where security is important, and with one, two or three tumblers for other locations, according to the conditions of use. Except when of heavy, and therefore somewhat expensive, construction, usually where the Bower-Barff finish, is desired, *no mortise locks*

*with cast iron fronts should be tolerated.* The fronts should be of steel, plated or capped with bronze, or else of solid bronze or brass. Cast iron bolts, bronze plated, are permissible, but those of solid bronze or brass are better and their cost not much greater. The keys should be of steel, preferably of the solid, cold-forged, type and nickel-plated. In this grade may be placed the "Vulcan" locks, (see page 128), made wholly of wrought metal, embodying many refinements and yet so moderate in price as to justify the claim that they are "the cheapest locks fit for use" within the range of architectural practice.

While the makers of the Yale Lock may fairly be said to have led the Trade in this direction, with their well-known line of "Standard locks" (introduced about 1875), all the larger manufacturers now make a variety of excellent locks of medium grade, and no difficulty exists in obtaining such goods if proper care is exercised in selection and specification. If the selection, however made, takes intelligent note of quality, and draws a fairly median line as to price, assurance may be felt that the goods will be fully up to the medium grade and that, if so, they will be suitable for all uses except those demanding the best grade of goods, but careful specification and rigid inspection will still be needed to ensure that the goods selected are actually used.

#### BEST GRADE.

Under this head come first the "Yale Locks," and others of the "cylinder" type, and these should be preferred for entrance and office doors, and all other places where high security is called for. For interior and communicating doors, locks of the "lever-tumbler" type are usually preferred, but these should be of the best and heaviest construction, with solid bronze or brass fronts and bolts, two or more tumblers, solid

steel or bronze keys, of the best workmanship and with the latest improvements. The larger locks of the "Vulcan" line fulfill these conditions. In the case of work of the importance thus implied it is always expedient, and usually feasible, to obtain expert advice from the manufacturer, or from a dealer representing him, whose intimate knowledge of the product can thus be utilized by the Architect to assist the latter in selecting the locks which will most suitably and exactly meet each of the various conditions involved. For example, the variety of Hotel locks, described elsewhere, is very large, and covers a wide range of styles and prices, but their differences involve so many technical questions as to preclude an entirely satisfactory presentation by any treatise, however full. Indeed, the higher the grade of locks the greater is the advantage to be derived from expert advice on the technical questions involved, and those best qualified by experience to give it will be found ready to respond cordially to such requests from Architects and others.

## Section 4.

---

### Master-keyed Locks.

A SERIES of locks is said to be "master-keyed" when so constructed that each lock can be operated by its own key, which fits it but no other lock in the series, and also by another key which will operate every lock in the series, this latter being designated as a "master-key" or "pass-key." A series of locks, therefore, may be arranged in either of three different ways, viz:

1. All different, each key opening only one lock.
2. All alike, any key opening all of the locks.
3. Master-keyed, with locks all different (as in No. 1), but with a master-key also, which passes all of the locks (as in No. 2).

Under Plan No. 1 the tumblers or wards in each lock are so made that it can only be operated by one particular key. Under Plan No. 2 the same statement applies, the tumblers or wards being identical in every lock of the series. Under Plan No. 3 the construction is such that each lock may be passed by two different keys, one the "change key" and the other the "master-key;" one of these being variable and the other constant throughout the series. Thus each master-keyed lock has two settings or changes, one of which is different and the other of which is uniform in every lock of the series, the master-key acting on the latter. Hence arises an unavoidable diminution of security in master-keyed locks, except only in the case of the Yale Duplex system described below.

The types of locks which are available for master-keying are the following :

A. Warded Locks; having fixed obstacles, or wards, to clear which the key must have corresponding wards or indentations.

B. Lever Tumbler Locks; having one or more movable obstacles or tumblers, which the key must set in a certain position to permit the bolt to move.

C. Pin-Tumbler Locks (Yale system); having pin-tumblers which the key must set in a certain position before it can rotate to actuate the bolt.

D. Yale Duplex System; having two separate pin-tumbler cylinders, one for the change key the other for the master-key, either of which controls the bolt.

A series of Warded Locks is master-keyed by means of a "skeleton" key, the bit of which is cut away sufficiently to avoid all of the wards in all of the locks of the series. This affords cheapness, but offers only a low grade of security, because a piece of wire, bent into form which will clear the wards and actuate the bolt, will operate any lock of this type. Warded locks, therefore, are only suitable where cheapness is the controlling factor and security is not essential.

A series of Lever-Tumbler Locks is usually master-keyed either by providing two "gatings" on each tumbler, one of which is brought in line with the corresponding "fence" or post on the bolt by the change key and the other by the master-key, or by providing a "lifter" which, when actuated by the master-key, moves the tumblers precisely as they are moved by the change key when the latter acts directly on the tumblers. A third arrangement consists in providing a set of secondary levers which, when operated by the master-key, move the primary tumblers in the same manner as the change key which acts on them directly. Any of these constructions, well made, affords good security at reasonable cost, and therefore this type of master-keyed lock is adapted to a wide range of uses.

A series of Pin-Tumbler Locks is master-keyed by cutting each pin in two places, or by encircling the plug (which contains the key-way) with a larger annular plug, the result in either case being to provide two points at which each tumbler may be set to permit the plug to rotate, and utilizing one set of these points for the change key and the other for the master-key. This system affords excellent security and is admirably adapted for some uses, but the number of key changes it admits of is limited.

A series of Yale Duplex Locks is master-keyed by providing each lock in the series with two pin-tumbler cylinders, either of which will operate the bolt, one of them controlled by the change key and the other by the master-key. This is the *only system* in which the original security of the tumbler mechanism is retained unimpaired, and in which the number of locks which can be combined in one series is limited only by the possible number of key changes. This system therefore affords the highest security, and by far the greatest capacity for grouping into one master-key series large numbers of locks.

A series of Master-keyed Locks may also be sub-master-keyed by dividing it into subordinate groups, each of which is controlled by a sub-master-key of its own (each lock having also its own individual key), or in each of which the locks are all alike and controlled by one key, each of these keys differing from the master-key, but every lock in the entire series being also controlled by a master-key which, in this case, is usually called the "grand master-key," to distinguish it from the "sub-master-keys."

In ordering master-keyed locks it is essential to specify, in addition to the usual information as to the list number of lock, thickness and hand of door, etc., the exact number and kind of locks to be grouped under one master-key, and the floor or rooms for which each group is intended, so that they may be packed and labeled accordingly.



Before the invention of the Yale lock every different size and style of lock had a different size and style of key, so that it was only possible to group together under one master-key locks of the same kind and size. In the Yale lock, on the contrary, the size and style of key are constant throughout almost the whole range of locks, covering hundreds of sizes and kinds and available for practically every use. The Yale lock has thus made it possible to group together, under a single master-key, locks adapted to practically every purpose. The possession of a master-key which will control many, if not all, of the locks which they have occasion to use will be a new idea to most individuals. The convenience, however, of having a single key which will control all of the locks in one's house, and also if desired at one's office, store or factory, and the resulting reduction of the usual bulky bunch of keys to a few small ones, of nearly uniform size and shape, is a luxury which will appeal to every one, but which can only be fully appreciated by experience.

The number of master-keys available with any given type of lock is limited. Therefore, unless proper care is exercised, there is serious danger that the same master-key may be furnished to two customers in the same city, or even in the same street or building. The only safety against this danger lies in maintaining a careful *record* of the location of the customer using each master-keyed series of locks. To "trust to luck" in this matter is to invite almost certain trouble for all concerned.

An additional reason for maintaining such record is the fact that additions to a master-keyed series of locks are often required, sometimes at long intervals. Unless a knowledge of the key changes used in the original series is available, it is not possible for the manufacturer to furnish such additions to a series of master-keyed locks without inevitable liability to duplications and interchange of keys.

For these reasons, especially the first, The Yale & Towne Manufacturing Company has always made it a rule to decline to accept orders for master-keyed locks unless advised as to the name and location of the party by whom they are to be used. The information thus furnished exists in records which have carefully been maintained for many years, and is used solely for the purposes above explained. The maintenance of this system is essential to the protection of all customers, past and future, purchasing master-keyed locks, and the information required is treated as strictly confidential.

The manufacturers, in making this explanation, state that "it is furnished to meet the objection occasionally raised that it is 'none of our business' as to what becomes of master-keyed locks after we deliver them to a customer, but we submit that it *is* our business not to furnish a customer with a set of locks to which his neighbor already has a key, nor with a key which will operate his neighbor's locks. We appeal, therefore, to our customers to cooperate with us in maintaining the integrity of the system, and the safety which it aims to provide for all users of master-keyed locks, by furnishing us, with each order, the information needed to maintain our records."

The use of master-keyed locks is rapidly increasing, and the subject merits careful consideration in connection with the selection of locks for buildings of all kinds. Master-keys have long been a *sine qua non* in the case of locks for hotel use, and have become almost equally so in the case of locks for office buildings, but their use can be extended, with advantage and convenience, to large buildings of all kinds. Even in residences the owner will appreciate the convenience of having a *single key* which will pass at least all of the important openings, such as the entrance doors, wine closet, stable, etc., usually secured by Yale locks. A specially appropriate field for master-keyed

locks is in large industrial works and factories, where many doors require to be locked, and where the higher officials desire convenient control of *all* locks, while giving to subordinates access only to certain rooms or departments, and this subject is one which merits the careful consideration of the Works' Manager who desires to avail of modern improvements.

It must be recognized, however, that some increase of cost is inevitable if master-keyed locks are availed of, and it is of prime importance that no false economy should influence the selection of the proper kind of lock. Cheap locks afford little security, and even this is lessened where such locks are master-keyed. Moreover, master-key devices imply increased complication of mechanism, which, if not well made is liable to get out of order and to entail trouble and expense. For all these reasons master-keyed locks, wherever used, should be of good and substantial construction, in which case they will be permanently satisfactory and well worth the moderate extra expense involved. Where the best possible construction is desired the Yale Duplex System should be availed of, especially where the number of master-keyed locks is very large.

This subject is one concerning which the advice and assistance of a technical expert is exceptionally desirable, and should always be availed of if possible.

See also article on Hotel Locks, Section 11.

## Section 5.

---

### Wrought Metal Locks.



**T**HE use of cast iron for locks is confined almost exclusively to America. In all European countries locks have always been made by hand and of wrought metal, their construction usually being clumsy and rough but substantial. Modern machinery, and, especially, modern steel of high quality and low cost, have combined to enable the American manufacturer to design and produce a new type of lock which combines the strength and durability of the best European locks with the mechanical excellence and moderate cost of the American cast iron lock, the new product being generally known by the name "Steel Locks."

The first practical step in this direction was taken, about 1889, by the Yale & Towne Manufacturing Company, by the introduction of a Builders' Lock (No. 1620S), with a case made of cold rolled and pressed steel, of high quality and moderate price. Several years later the "Warner" and other steel locks were brought out by other makers, but although of handsome external appearance their internal construction followed old lines and, in some cases, was distinctly inferior to that of good cast iron locks, quality being subordinated to cheapness. In this way a temporary prejudice was created against "Steel Locks" which was justified by the facts on which it rested but not by the inherent possibilities of the new material if rightly used.

Again the Yale & Towne Manufacturing Company furnished the practical solution of the question, when, in 1896, after nearly two years of preparation, it brought out its line of high grade "Vulcan" Locks, supplemented two years later by the "Vulcan, Jr." line, of cheaper construction, designed for ordinary commercial use. This new product embodies so many radical improvements, and has found such large acceptance by architects and builders, as to justify the following reproduction of the descriptive pamphlet issued by the makers when the "Vulcan" Locks were first brought out.

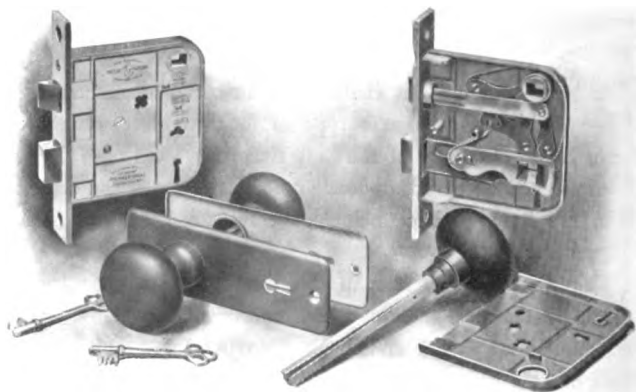

Fig. 1.

### THE VULCAN LOCKS.

The age of iron is passing and the age of steel is fully born. America has long excelled in small products of cast-iron, but it is discarding them for better ones of wrought steel. Both were formerly hand products; cast work so remains, but wrought work, in quantity, is now produced from the wrought sheet or by machine processes which supersede hand labor.

This new material, and these processes, have already been utilized in creating modern fire-arms, the sewing machine, the American watch and the bicycle; they are now availed of to create a new American product, namely, a door lock formed wholly from wrought materials, machine made throughout and interchangeable in all its parts.

The substitution of machine processes for hand labor, has not only produced a more perfect article, but has also effected economies which enable the Vulcan Locks to be sold at prices so low as to make them available for every purpose.

New and improved mechanisms, made possible by these new and better materials and processes, combine to make the resulting product the most important advance in the art of lock making since Linus Yale, Jr., one of the founders of The Yale & Towne Manufacturing Company, a few years before his death, in 1868, invented the Lock which will forever be associated with his name and which has completely revolutionized American practice in lock making.

#### CONSTRUCTIVE FEATURES.

**THE CASE AND CAP.** (Fig. 1.)—These are of cold-rolled steel, each flanged on the outer edge and ribbed in transverse lines, thus obtaining greater rigidity and far greater strength than that of a cast lock of twice the weight.

The dimensions and weights of all the parts are those suitable to give proper strength. All the parts being of wrought metal, the total weight is somewhat less, and the strength of each part much greater, than if cast metal were used.

**THE FRONT.**—As shown by Fig. 2, this consists of a wrought steel base, attached to the case by two cheeks, over which is drawn a skelp or cover of wrought bronze, clinched over the tapered edges of the base, thus firmly uniting the two and pro-

ducing a front of great stiffness, having true edges, beveled to fit snugly into the wood, and a surface admitting of the highest polish. This construction is further illustrated by the enlarged detail in Fig. 3, showing a cross-section of the completed front.

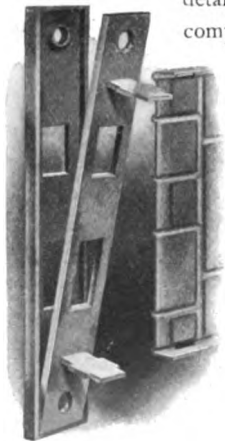

Fig. 2.

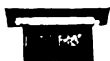

Fig. 3.

**THE BOLTS.**—The Latch-bolt and the Dead-bolt each consists of a solid head of wrought bronze or steel, and a wrought steel tail-piece, forced into the head and secured thereto by riveting and by setting down the metal of the head over interlocking projections on the tail-piece, as shown by the illustration of latch-bolt in Fig. 4. The tail-pieces are ribbed or corrugated to give added stiffness.

**THE KEY.**—The key of the Vulcan Lock, shown by Fig. 5, is of solid steel and is cold-forged from open-hearth metal. It is machine finished, nickel-plated and finely polished. Its bow is of the well-known Trefoil design,

so long identified with the Yale Lock, and bears on one side the Trefoil trade mark of the makers. The form of the key is peculiarly graceful, and its oval cross-section gives great strength.

The bit is tapered, being thickest at the outer edge, thus giving a better wearing surface, and a smoother action on the tumblers and bolt, than keys having thin bits.



Fig. 4.

**THE COMPLETED LOCK.**—The external and internal appearance of the several parts when completed and assembled is shown by Fig. 1.

**THE CYCLOID KNOB ACTION.**—In this is embodied a new principle and a great advance in lock mechanism. It discards the sliding action used heretofore and substitutes pivotal motions and inter-gearred levers, every piece being machine made from wrought metal. Fig. 6 shows the mechanism in its normal position. The hub, by which the rotary action of the knob is transmitted, has a single arm or cam projecting diagonally downward. Bearing against each side of this cam are two pivoted levers, geared together at their other ends, so that motion of the cam in either

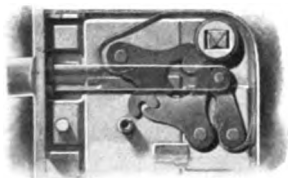

Fig. 6.

direction produces the same effect upon the levers, causing the lower one to move backward, carrying with it the third lever, to which is pivoted the end of the latch-bolt. Fig. 7 shows the parts in the position they occupy when the latch-bolt is forced back, as in closing the door. One of the inter-gearred levers has a heavy spring, giving the desired resistance to the knobs. The third lever is independent and has its own lighter spring, acting both on the knob and the latch-bolt. This spring alone opposes



Fig. 5.

direction produces the same effect upon the levers, causing the lower one to move backward, carrying with it the third lever, to which is pivoted the end of the latch-bolt.

Fig. 7 shows the parts in the position they occupy when the latch-bolt is forced back, as in closing the door. One of the inter-gearred levers has a heavy spring, giving the desired resistance to the knobs. The third lever is independent and has its own lighter spring, acting both on the knob and the latch-bolt. This spring alone opposes

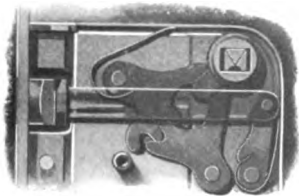

Fig. 7.



resistance to the retraction of the latch-bolt, while both springs oppose rotation of the knobs. The most perfect "easy-spring" action is thus obtained. The latch-bolt is reversed by removing cap of lock. Fig. 8 shows the latch-bolt retracted by rotation of the knob in either direction, and shows also the construction of the hub or cam from two pieces of wrought metal, machine made throughout. As seen in Fig. 1, the holes or trunnions in the lock case are flanged inward to provide a broad bearing for the ends of the hub, these bearings being accurately fitted by machine processes. The bearings for the key are formed in like manner.

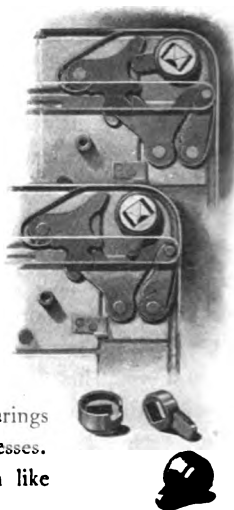

Fig. 8.

In other wrought metal locks these bearings are merely holes punched in the metal, and their thin edges tend to cut into the metal of the hub or key, the result being rapid wear, which, in the case of the hub, produces looseness and rattle, and, in the case of the key, disturbs its relations with the tumblers so that it soon works badly and ultimately may fail to operate the lock. The broad bearings in the Vulcan Lock obviate all of these difficulties.

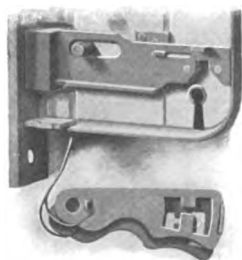

Fig. 9.

**THE DEAD-BOLT ACTION.**—The method of constructing and guiding the Dead-bolt is shown by Fig. 9. Its bottom edge is flanged to give stiffness, its rear end is thickened by a reinforce

to give a broad bearing for the key in the "talon," and its motion is guided and checked by a stud attached to the case and fitting within a guide-slot in the bolt-tail.



Fig. 10.

The Tumblers, of which in some locks there are two and in others three, are of the double-acting lever type, as also shown in Fig. 9. The "fence" or post on tail of bolt fits within the segmental openings of the tumblers and must pass the narrow gating between them to permit the bolt to move. To accomplish this the key must accurately raise each tumbler to the exact position, neither too high nor too low, to permit the fence to enter and pass through the gating, thus securing ample protection against picking and against the unintentional interchange of keys. Fig. 10 shows the key in place ready to operate the tumblers and retract the bolt.

**THE TRIPLEX SPINDLE.**—This Spindle, already in use with the Yale Locks, is used also with the Vulcan Locks. (See Section 15).

**THE COMPENSATING HUB.**—Heretofore lock makers have ignored the fact that all wood shrinks and swells with changes in the humidity of the atmosphere. Hence has arisen the dilemma that knobs must be loosely fitted or else will bind. This is due to the conditions illustrated by Fig. 11. As there shown the lock is attached by its front to the edge of the door, while the escutcheon plate (which carries the knobs) is attached by its screws to the surface of the door at the distance "X" from its edge. Any shrinkage or swelling of the wood causes this distance "X" to vary and thus tends to cause the knobs if well fitted, to bind. The Compensating Hub, as shown by Fig. 11, has a rectangular opening which fits the spindle vertically, but which is considerably elongated horizontally. Changes in the

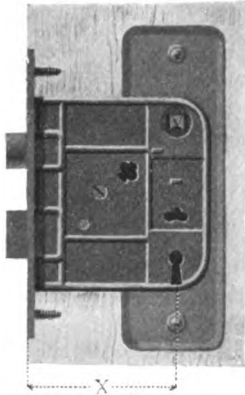

Fig. 11

dimension "X" may thus occur without causing the knobs to bind, and yet rotation of the knobs will cause the spindle to actuate the hub, by contact of the upper and lower sides of the spindle with the opposing faces of the opening in hub, as perfectly as if all four faces of the spindle and hub-opening were in contact, as heretofore. This simple device makes possible the use of perfectly fitted knobs by eliminating the disturbance arising from shrinkage, which heretofore has been so common a cause of trouble.

**THE BRACKET BEARING.**—A lock spindle is practically a short piece of shafting, with a wheel or pulley (the knob) on each end. Obviously the bearings of such a shaft should be as far apart and as near to its ends as possible. In common locks, on the contrary, they are at the surface of the door and therefore near together. This has long been remedied in the case of the Yale Lock by the use of the "Bracket Bearing," which will also be used with the Vulcan Locks. It consists of a construction of the knob shank, and its supporting thimble, such as to bring the bearings or points of support as close to the knobs, and therefore as far apart as possible. The mechanical difference between these methods will be apparent from Fig. 12, which shows the old and the new constructions. The dotted lines show the play or "wobble" of the common knob, with its clumsy adjustment by means of a row of screw holes in the spindle, supplemented by tin washers in the loosely fitting thimble or bearing close to the surface of the door.

In marked contrast to this is the easy and perfect adjustment

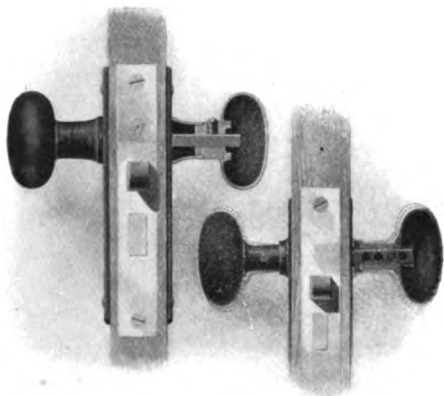

Fig. 12.

o. the knob by means of the Triplex Spindle; the supporting of the thimble close to each knob; the well-fitted Bracket Bearings in which the knob rotates, as shown in the left-hand picture.

**THE MECHANICAL COMBINATION.**—The Triplex Spindle, admitting of perfect longitudinal adjustment of the knobs, the Compensating Hub, which eliminates disturbance from shrinkage and swelling of the wood, and the Bracket Bearing, which supports and guides the two ends of the spindle close to the knobs, combine to produce a perfect mechanical assemblage, easy to apply, eliminating all causes of future disturbance, pleasing, because inherently right in appearance, and, as already proved, certain to give permanent satisfaction.

**THE TRIM.**—Fig. 1 shows one of the plain, wrought metal trims used with the Vulcan Locks, but, in addition to plain trim, in bronze, brass or Bower-Barffed steel, they are furnished with ornamental trim in great variety. These ornamentations, and also the extensive line of Vulcan Locks, are described and illustrated in a separate catalogue.

**THE RESULT.**—The many and important improvements herein briefly referred to are the outcome of the work of several years, aided by unrivaled facilities and by the experience of the makers of the Yale Lock, acquired during the past twenty-five years. The final result is the creation of a new mechanical product, as far in advance of all predecessors as is the Yale Lock in the field where it has so long held a position of undisputed leadership.

## Section 6.

---

### “Cylinder” and “Pin-tumbler” Locks.

**T**HESE terms have come into general use to designate locks of the “Yale” type ; the name “cylinder lock” applying to Builders’ and other locks in which the pin-tumbler mechanism is contained in a “cylinder” separate from the lock case, and the name “pin-tumbler lock” being usually employed to designate Cabinet and other small locks in which the pin-tumblers are contained in the lock itself, although the latter term applies broadly to both groups.

As all other makers of these locks have copied the Yale Lock, more or less closely, it is unnecessary to repeat here the very full description of this type of lock given on page 71. It is proper to point out, however, that in cylinder as in other kinds of locks, there is room for a wide range in quality, and a corresponding need of careful selection. Copies are rarely as good as originals, because not based on the same long experience and complete knowledge, added to which, in some cases, are lower standards of workmanship and an effort after cheapness. But most locks of this type aim to be of better quality than common locks, and many are thoroughly good, although, of course, none but the genuine Yale Lock have the Paracentric Key and Key-way (see page 77) and other latest improvements.

All cylinder locks are not necessarily of the pin-tumbler type. Other kinds of tumbler mechanism have been adopted in connection with lock “cylinders,” some of which are fairly good, but others distinctly bad. Those who like to experiment can select the better of these modifications, but those who prefer otherwise are advised to avail of articles of established reliability, especially at the small difference in cost which usually exists.

Cylinder locks should be given preference for all important uses, especially for the entrance doors of residences, stores and offices, not only because of their high security but also because the keys of such locks are, as a rule, carried in the pocket, and no other keys are so convenient as those of the Yale type. Cylinder locks, on the contrary, are not expedient for hotel use, because the small key is liable to be lost or accidentally carried away, nor for interior doors of communication the keys to which are commonly kept in their locks. A good general rule is to adopt cylinder locks *wherever the key is to be carried habitually in the pocket*, and elsewhere to use lever-tumbler locks of good quality.

## Section 7.

### Keys.

**K**EYS are made in endless diversity of size and form, but can all be classified into a few types.

**THE ROUND CAST KEY (Fig. 1).**—This is the commonest type and is used with a great variety of Builders' Locks.



Fig. 1.

Made of cast iron it is easily broken, and is only used with the cheapest locks. Made of malleable iron, and tinned or coppered, it is serviceable, although not handsome. Made of bronze or brass it is excellent, and if then well finished, is suitable for any appropriate use.

**THE ROUND STEEL KEY (Built up.) (Fig. 2).**—This key, built up of several pieces well united, was formerly very popular and is still much used, although now being displaced by the solid steel key. It is smaller and neater than the cast key, and usually better.

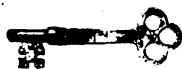

Fig. 2.

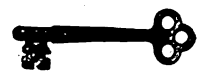

Fig. 3.

**THE SOLID STEEL KEY (Fig. 3).**—This is a single piece of wrought steel, usually cold-forged, and, being in all respects the best key of this type, should always be given the preference.

**THE BARREL KEY (Fig. 4).**—This is a round key with a hole in its end to fit over a pin in the lock, and obviously can be made in the same manner as any of the foregoing.



Fig. 4.

It can only be employed where the lock has a key-hole on but one side, or if on both sides not opposite,



and hence is little used, except with cabinet locks, and with certain hotel locks, for which latter it is to be recommended.

**THE CYLINDER LOCK KEY.**—This is always of the Yale type,



Fig. 5.

and nearly always has the trefoil bow, (as shown by Fig. 5) which was used originally with the Yale



Fig. 6.

Lock and has been copied by almost every lock-maker. The *genuine* Yale Locks *now* all have Paracentric Keys, with the new design of bow shown by Fig. 6, the key being made of nickel bronze, and its bow gold plated.



Fig. 7.

**THE FLAT STEEL KEY.**—This requires a revolving “center,” or hub, in the lock to



Fig. 8.

guide and support the key, and is not much used with Builders' Locks. When so used its form is usually as shown by Fig. 7. It is extensively used with cabinet locks, however, and in two forms, viz: Single-bitted as shown by Fig. 8, and double-bitted as shown by Fig. 9. It is also extensively used with padlocks and trunk locks. A key with flat bow and bits and a round stem is shown by Fig. 10.



Fig 9.

In selecting locks the style,



Fig. 10.

size, material and finish of the keys should all have due consideration.

The *number of keys* per lock varies. Cylinder locks are always furnished regularly with three keys each, while other Builders' locks usually have only one key each. If more are required they should be called for in specifications. For interior doors one key per lock is usually enough, as if two are supplied the extra one can seldom be found should it be needed.

Duplicate and extra keys can usually be obtained from dealers and locksmiths, or, if not, by application to the maker, whose name and address can usually be found on the key or its lock. On this point, however, note the further information given on pages 77 and 124.

## Section 8.

### The Front Door Lock.



TECHNICALLY a front door lock is one having two bolts, a dead bolt and a spring bolt (or night latch), and equipped with a pair of knobs, to operate the latch bolt, so arranged that the *outer knob*, by means of a "stop," may at will either be set to operate the latch bolt or be cut off or stopped so that it cannot operate it, in which latter case a key is required to operate the latch bolt from the outside.

Formerly each of the two bolts was operated by a separate key, but in 1869 the fact was perceived (by the author) that the Yale system admitted of an arrangement whereby one key would suffice to operate *both bolts*, and the original Yale front door lock was designed accordingly. This arrangement was never patented and is now in common use, having been applied both to cylinder and lever-tumbler locks.

The "cylinder" type of lock is the best, in every respect, for front door use. The sole merit of other types is slightly lower cost, and their use is now generally limited to dwellings of the cheapest class. A front door lock of the Yale (or "cylinder") type affords its owner the highest security, the most convenient key, the control of his entrance door at all times, and the opportunity to enjoy the luxury of having a single "master-key" which will operate this and all other

important locks he uses. Information as to the sizes, styles and prices of front door locks is given in Part IV.

Where a residence has an inner, or vestibule, entrance door, a front door lock can be used on it also, but it is more customary to use a "vestibule latch," which is a front door lock complete in all respects except that the dead bolt is omitted. In either case the two locks should be "alike," that is, so that the same key controls both.

Where a front door already has a lock of the old type, and the owner desires the safety and convenience of a Yale lock, it is customary to apply a separate "cylinder" Night Latch, above the front door lock, setting the "stop" of the latter so that its night latch mechanism will be inoperative, but the better plan, where the moderate difference in cost is not objectionable, is to replace the old front door lock with a modern one of the "cylinder" type.

A special form of front door lock is made which is so arranged as to permit the use of handles and thumb-pieces, in place of knobs, for operating the latch bolt, as explained in the article on store door trim, page 159.

For iron and bronze doors and grilles a front door lock is made with one-inch backset, thus greatly reducing the width of the lock and adapting it to the narrow stiles common to such doors. This lock necessitates the use of lever handles in the place of knobs, and where they are used it is better to omit the "stop-work," as the unbalanced weight of such handles is liable in time to derange the stop mechanism.

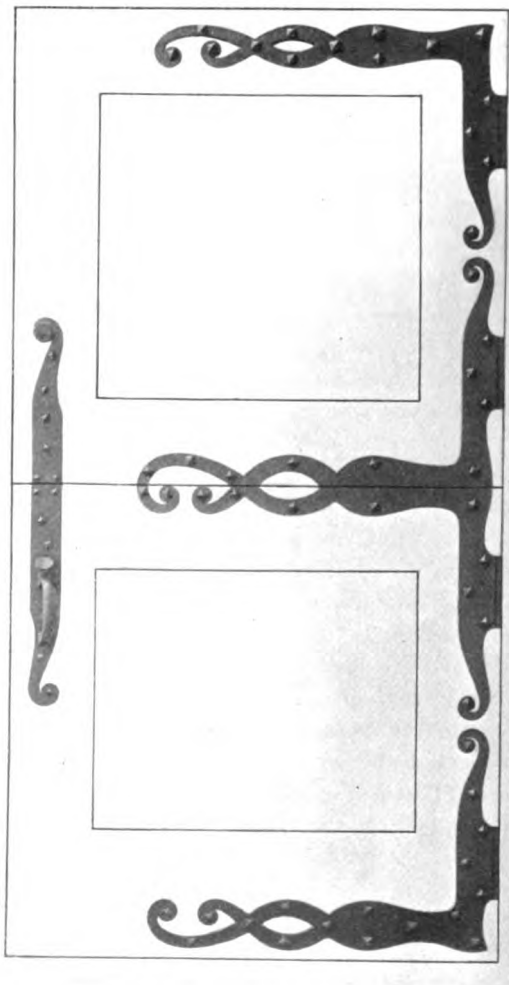
**Trim for Dutch Door.**

## Section 9.

### Dutch Door Trim.



use of the so-called "Dutch" door for entrances, that is one divided horizontally into an upper and lower leaf, is quite common, especially in country houses, and such doors require some special fastenings.

For the lower leaf the best fastening is a vestibule latch, that is a lock having a spring bolt operated from either side by the knobs, and from the outside by the latch key. Frequently a store door handle with thumb-latch is substituted for the outer knob, in which case a special lock is needed (such as No. 732). A handle of this kind is more in character with the style of such a door than a knob, although the knob is usually preferred on the inside. The stop-work of this lock enables it to be set so that it may be opened from the outside either by the knob (or handle), or only by the key, as preferred.

For the upper leaf a mortise dead lock (such as No. 348) is best, the bolt of which is operated from the outside by key and from the inside by thumb-knob or key, as preferred. The joint between the two leaves being rabbeted, the dead lock on the upper leaf serves to secure both.

To secure the two leaves together the best fastening is a mortise knob latch, rabbeted to correspond with the edges of the doors, (such as No. 1000R). This should have a knob on the inside only, whereby the latch can conveniently be withdrawn when it is desired to move the upper leaf separately from

the lower leaf. Occasionally a quadrant, or other clamping device, is added to draw the two leaves tightly together.

The accompanying illustration (page 144) shows a well designed ornamental *trim* for a Dutch door, so arranged as to preserve its effect whether the two leaves are united or separated; the *fastenings* consist of a simple latch on the lower leaf, operated by a thumb handle, and a cylinder dead lock on the upper leaf, the two leaves being fastened together by a knob latch operated by knob on the inside of door.

## Section 10.

---

### Locks for Residence Use.

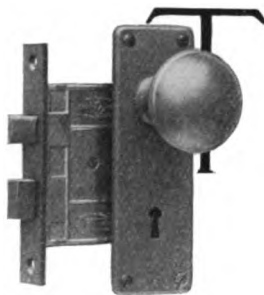

THE subject of Locks for Entrance Doors has been discussed in the article on Front Door Locks, page 142, supplementing which the following suggestions are offered as to the selection of locks for the inside doors of private residences.

Yale locks, of the cylinder type, are only advisable for rooms and closets usually kept locked, the keys to which are habitually carried, and where privacy and safety are desired; elsewhere locks of the lever tumbler (bit-key) type, with solid steel keys, are preferable, especially if the keys are to be retained in the locks. Great convenience will result from having all the Yale locks in a residence, including those on entrance doors, set to a master-key, the possession of which will give the owner control of all such locks, although each of them may also have its own individual or "change" key, differing from all others in the series. When locks are so wanted, the original order should specify that they are to be master-keyed. Further convenience will result in most cases from having the keys for room and closet doors alike throughout the house, or alike by floors, instead of all different, as is the common practice. In this way, the loss of a key will cause little or no inconven-



ience, as any key will open any lock in the series, while privacy and security to the occupant of a room will remain unimpaired because the presence of a key in its lock will prevent the insertion of another key from the other side of the door. The adoption of this reform is recommended to architects, and will be appreciated by their clients.

For the main, or parlor floor, 4 or 4½ inch two-bolt knob locks should be used for swinging doors, and 5½ inch locks for sliding doors; the latter containing a dead bolt only (so constructed that unequal settling of the doors will not prevent its free action), and a pull or handle by which to withdraw the door from its recess. Other forms of locks for sliding doors are made to meet special cases. Knob locks may be trimmed either with knobs or lever handles, the latter conforming to French and German practice and being especially suitable on French windows and on doors with narrow stiles. Locks for sliding doors were formerly trimmed with knobs, but present practice favors the use of cup escutcheons, which permit the door when open to slide entirely into its recess, so that only its edge is visible, the lock used in such cases having a pull or hook in its front whereby the door may be pulled out of its recess.

For closet doors, on all floors, it is best to use a two-bolt knob lock, of 4 inch size, with trim on both sides, so that the door may be opened from the inside in case it is accidentally closed while a person is in the closet, and so that it presents a good appearance if standing open; but a slight saving may be effected on doors for shallow closets by omitting the inside trim and using only a half-pair of knobs. In many cases a knob latch, without dead bolt, is sufficient. For wine, silver and linen closets, etc., a Yale lock should be used. This is usually

a mortise or rim night latch, although a dead lock is sometimes preferred. A knob latch may be added below, and is sometimes convenient.

For bedroom doors a 5 inch three-bolt knob lock is best, because providing a thumb-bolt on the inside in addition to the dead bolt operated by the key. While it is customary to use the full trim on both sides of such locks, that is, an escutcheon plate having on the outside a knob and key-hole, and on the inside a knob, key-hole and thumb-piece, a more pleasing effect may be obtained by using a separate knob rose and key-plate on the outside, and on the inside a knob rose and thumb-piece. Where a smaller and cheaper lock is wanted a 4 inch two-bolt knob lock is suitable, and this may be supplemented by a separate thumb-bolt.

For basement and attic floors 3 1/2 or 4 inch mortise locks are appropriate, and where economy is sought may have steel fronts, bolts and trim, bronze or brass plated. Rim locks are still cheaper, but are rarely used except in buildings of the cheaper grade.

Bathroom doors should always be provided with a thumb-bolt, either separate or combined with the main lock.

Communicating doors between rooms should have a three-bolt knob lock, the latch bolt operated by the knob from either side, and below this two dead bolts, operated by thumb-pieces on opposite sides of the door. Locks of this character are made both for swinging and for sliding doors.

Twin doors (see page 151) are sometimes used in residences, to deaden sound and to increase privacy, and should have the same locks and trim as other communicating doors, except that, because of the limited space between them, the trim on the

abutting faces of such doors must usually be special, to prevent interference. For this purpose both knobs and lever handles are made which project very slightly from the door.

Where double swinging doors are used, their abutting edges may be either rabbeted, or covered by astragals; if rabbeted, the locks should be ordered accordingly, and the step of the rabbet should be one-half inch, to conform to the locks.

## Section 11.

### Hotel and Office Locks.

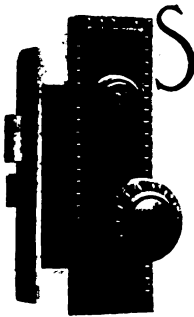

SECTION 4 of this Part (page 121) explains the construction and uses of master-keyed locks, but the employment of such locks in large groups, as in the case of large Hotels and Office Buildings, calls for further discussion.

The term Corridor Door designates the entrance from a corridor or hallway to a bedroom or office; Communicating Doors are those between adjacent rooms; Closet Doors are those to closets within a room. Any

of these may be double or single, hinged, or sliding. A Twin-Door is one of a pair of communicating doors, *each* fully closing the *same* door-way between adjacent rooms, one opening into each room, the purpose being to increase privacy by deadening the transmission of sound, a practice common in Europe and worthy of all encouragement here, especially in view of the American tendency to needlessly provide communicating doors between bedrooms in hotels.

Each of these doors require a knob lock, that is one having a *latch* bolt operated by knobs and a *dead* bolt operated by a key, except that the dead bolt is sometimes omitted in the case of locks for closet doors, and that a thumb-bolt is sometimes substituted for the dead bolt in the case of locks for communicating doors. While all of the locks thus enumerated are used in Hotels, and most of them in Office Buildings, technically a "Hotel

lock" is a master-keyed knob lock for doors from corridors to bedrooms, and an Office lock is an inverted knob lock, (*i. e.* with keyhole above the knob), usually master-keyed, for doors from corridors to offices.

Such locks may be master-keyed on any of the systems explained in Section 4 (page 121), but while for offices the cylinder lock, with small key, is distinctly the best, because its key is permanently carried, a high grade lever-tumbler lock, with round key of substantial size, has heretofore been preferred for hotel use, because the keys are liable to hard usage, and it is not desirable that they should be too portable.

Hotel locks vary widely in *arrangement*, as well as in size, quality and price. As the simplest way of explaining these variations the following tables are given of typical Corridor Door locks with various key and bolting mechanisms, made by the Yale & Towne Manufacturing Company. Those for Hotels are shown on opposite page and those for Office Buildings on page 157.

#### HOTEL LOCKS.

The *latch bolt* is generally operated by the knobs, from both sides of the door; the *dead bolt* action varies as stated in table on opposite page.

As used in table, "C" designates the change or guest's key and "M" the master-key. Either of these may be of the solid or barrel type. The key-holes may be opposite or not, that is, in line or out of line with each other.

In some locks there is only *one* dead bolt: in others *two*, each

---

#### FOOT NOTES TO TABLE ON OPPOSITE PAGE.

\*"C" designates the Change or Guest's key. "M" designates the Master-key. Either of these may be of the Solid or Barrel type. "T.P" designates Thumb-piece. "Dbl." designates Double. "Inverted" designates that the keyhole is above the knob. Keyholes may be opposite or not opposite, that is *in* or *out* of line with each other. In Y. & T. locks this difference in position is always vertical.

†Prices are for the lock only *without* Trim, but *with* Bronze or Brass Front and B-

Catalogue No.	Size Inches	Key Changes.	Price Each.†	DEAD BOLT OPERATED FROM	
				Outside*	Inside*
1685	6 $\frac{3}{8}$	43,680	\$11.00	By C at all times, and by M when locked from outside, but not when locked from inside.	By C only. Keyholes not opposite.
1695	6	3,600	10.50	By C and M at all times.	By T-P only. Keyholes opposite.
1696	6	3,600	9.00	By C and M, except when locked from inside.	By T-P only. Keyholes opposite.
1697	6	3,600	10.50	By C at all times, and by M except when locked from inside.	By T-P only. Keyholes opposite.
1698	6	3,600	10.50	By M at all times, and by C except when locked from inside.	By T-P only. Keyholes opposite.
1699	6	3,600	10.50	By C and M at all times.	By C and M. Keyholes opposite.
1690	6	4,800	8.50	Dbl. Bolt. by C and M, except when locked from inside.	By C only. Keyholes not opposite.
1680	5 $\frac{1}{2}$	2,400	8.25	Dbl. Bolt. by C and M, except when locked from inside.	By T-P only. Keyholes not opposite.
1680 $\frac{1}{2}$	6	2,400	8.25	Same as 1680 but "inverted."	By T-P only. Keyholes not opposite.
1670 $\frac{1}{2}$	6	1,920	7.50	Dbl. Bolt. "Inverted." By C and M, except when locked from inside.	By C only. Keyholes not opposite.
1671 $\frac{1}{2}$	6	1,920	8.00	(For communicating doors) by C and M at all times.	By same or different C key and by M. Keyholes not opposite.
1402	5	1,920	5.00	By C and M at all times.	By C and M; also T-P. Keyholes opposite.
P2535	5	1,920	5.10	By C and M at all times.	By C and M; also T-P. Keyholes opposite.
1445	4 $\frac{3}{4}$	1,920	6.50	By C and M at all times.	By T-P only. Keyholes opposite.
1500	4 $\frac{1}{4}$	1,920	2.85	By C and M at all times.	By C and M at all times. Keyholes opposite.
1620	3 $\frac{1}{2}$	1,920	2.30	By C and M at all times.	By C and M at all times. Keyholes opposite.
P1793	5	300	3.80	By C and M, except when locked from inside.	By C and M. Keyholes not opposite.

\* † For foot notes see opposite page.

operated from one side only, and in still others a *thumb-bolt* operated from the inside only.

An "inverted" lock is one with key-hole above knob.

Lock No. 1685, in table, (page 153) was designed and made expressly for the Waldorf-Astoria Hotel, New York, and is unquestionably the best of its kind, its key-action giving exactly the protection and facilities which are most desirable. It does not embody an inside thumb-bolt because the laws of New York require an inside bolt, *separate from the lock*, on the door of every hotel bed-room. The one used in the Waldorf-Astoria is No. 1050. In some locks, Nos. 1402 and P2535 for example, a thumb-bolt is incorporated with the lock, while in still others, Nos. 1695, 1696, 1697 and 1698, and No. 168c for example, there are *two* dead bolts, one operated by the keys from the outside, and the other by keys or by a thumb-piece or knob from the inside.

The kind of "action" to be adopted in a hotel lock is usually determined by the preference and experience of the hotel manager, and it is desirable that he should be consulted in advance, but it varies also according to the location and uses of each door, and the whole subject is one requiring most careful consideration. (See specifications for Hotel locks in Part IX.)

A new departure has been made in some of the finest hotel buildings recently erected in New York by using the Yale lock ("cylinder type") on all corridor doors. In some cases a regular front door lock (No. 726,) has been used, the "action" being as explained on page 142. By far the best practice, however, consists in using the Yale Duplex latch No. 6274, (see table page 157,) which combines with the results obtained by Hotel lock No. 1685, the great advantages of the "Duplex" master-key system, and all the good qualities of the Yale lock. The No. 6274 lock has a latch bolt, operated by

knobs from both sides and by key from the outside only. A thumb-knob on the inside locks the door against the master-key but *not* against the change-key, while the latter will always open the door from the outside. The main knobs are on a swivel spindle, with stop-work whereby the outside knob may be stopped or not, as preferred. In one large hotel these locks are arranged as follows: the regular "armor-plate" (or false front) of the lock is not pierced for the stops, thus keeping the outside knob permanently stopped, so that the door can only be opened from the outside *by the key*, but a supply of special "armor-plates" is provided, which are pierced for the stops, thus enabling the outside knob to be stopped or unstopped at will, and where a permanent guest prefers the latter "action" the lock is so altered by simply changing its armor-plate.

The grouping of locks in a hotel under various master-keys is another phase of the subject, also requiring careful consideration *in advance*. The usual, and best, plan in large hotels is to group all locks on each floor under one master-key, and to provide a different master-key for each floor. In some cases a "grand master-key" is also provided which will pass all of the locks on every floor, this entailing some extra expense, but this plan is open to the objection that in case one such key is lost entire safety can only be re-established by resetting the *entire series* of locks to a new grand master-key. In like manner safety demands that in case of the loss of *any* master-key all of the locks controlled by it should at once be reset to a new "change" or combination. This is a troublesome and expensive matter, involving the removal of every lock from its door, and, therefore, the custody of all master-keys should be limited to the smallest possible number of responsible persons.

In arranging the grouping of locks under a master-key system it is often expedient to have some, or even many, of them set



to the same change-key, rather than to different keys, and so doing tends to simplify the system ; whereas, in other cases, it may be desirable to have every change key different, and every lock controlled by the master-key, but a certain group of the locks controlled also by a sub-master-key, although so doing further complicates the system. In the case of buildings requiring large numbers of master-keyed locks, especially if the grouping is complicated, consultation *in advance* with the lock-maker, or other qualified expert, is always to be advised.

#### OFFICE LOCKS.

Most of the remarks above, relating to Hotel locks, apply equally to Office locks, especially as to master-key arrangement, but the two types of locks differ considerably, both in use and in "action."

In response to an early demand for a lock adapted to the requirements of the modern office building, the author (about 1883) designed a "cylinder" (Yale) knob-lock, in which the knobs were placed *below* the key-holes instead of *above* them as is customary. Experience quickly showed that the "inverted" lock is the best form for office doors, and nearly all office locks are now so made. It is also occasionally preferred for front door and other use. A Hotel lock must secure the door both when the room is occupied and when it is not, whereas an Office lock is chiefly to secure it when *not* occupied : hence certain differences in "action" arise.

As the simplest way of explaining these variations we give on opposite page a table of typical Office locks made by the Yale & Towne Manufacturing Company. The reference letters in table have the same significance as in the preceding table of Hotel locks, most of the locks, however, being of the Yale type, with Paracentric keys. The prices are for the locks only, without trim, but with bronze or brass front and bolts.

Catalogue No.	Size Inches	Key Changes.	Price Each †	LOCKING ACTION EFFECTED FROM	
				Outside*	Inside*
654	5½	50,000	\$13.20	By C and M.	By C and M.
614	5½	50,000	13.20	" " " "	" " " "
660	4½	50,000	11.60	" " " "	" " " "
750	6	50,000	15.20	" " " " when Knob is set by Stop.	By T-P. only.
656H	5	50,000	8.30	By C and M when Knob is set by Stop.	By Knob at all times.
600	5½	50,000	13.00	By C and M except when Latch is dogged by T-P.	By C and M except when Latch is dogged by T-P.
770H	4¾	50,000	10.80	By C and M except when Latch is dogged by T-P.	By C and M except when Latch is dogged by T-P.
790	5	50,000	10.50	By C and M when Knob is set by Stop.	By Knob at all times.
1442M	5	2,400	6.90	By Knob and Key.	By Knob and Key.
1500M	4¼	1,920	4.00	" " " "	" " " "
2330M	3½	1,920	3.25	" " " "	" " " "

DUPLEX LOCKS.

6614	6½	50,000	\$22.25	By C and M.	By C and M.
6615	6½	50,000	20.25	" " " "	By C only.
6616	6½	50,000	18.25	" " " "	By Knob only.
6274	6⅞	50,000	16.00	" " " " when Knob is set by Stop.	By Knob at all times.
6270	6⅞	50,000	16.75	By C and M except when Latch is dogged by T-P.	By Knob except when Latch is dogged by T-P.

\*"C" designates the Change or Guest's key. "M" designates the Master-key. Either of these may be of the Solid or Barrel type. "T-P" designates Thumb-piece.

† Prices are for the lock only, *without* Trim, but *with* Bronze or Brass Front and Bolts.

All Office locks have a latch bolt, operated from both sides by the knobs, to hold the door in the closed position and yet permit free ingress and egress, but various methods are employed to lock the door against ingress except by means of the key. In some locks the latter purpose is accomplished by means of a separate dead bolt, operated by key from either side (thus enabling the door to be locked *from the inside* as well as from the outside). In others it is accomplished by the latch bolt only, by providing the latter with "stop-work," like a front door lock, (see page 142), whereby the outer knob may at will be "stopped" so that the latch bolt cannot be operated by it but only by the key, or by a construction whereby the latch bolt may be dead-locked from the outside by the key, so that it cannot be operated by the knob until released by the key. The choice between these various arrangements, or "actions," is entirely a matter of personal preference.

The remarks under table of Hotel locks as to grouping by floors and corridors, and as to use of master and grand master-keys, also apply to table of Office locks.

## Section 12.

### Store Door Trim.



**T**HE technical term "Store Door Lock" originally designated a heavy dead lock, whether rim or mortise, but is now applied also to a combined lock and latch, the latter arranged for operation from either side by a thumb-piece located above a pull handle, as shown by the illustration. Such locks are made in a variety of sizes and styles, the best being of the "cylinder" type, the thumb latch being used during the day and the dead lock serving to secure the door at night.

A Front Door Lock is also made, with its latch arranged for operation by thumb pieces, for use where it is desired to substitute a pair of store door handles for the customary knobs, in which case a night latch action is obtained.

Plates and handles for the combined store door lock and latch are made in a great variety of sizes and styles, from the plain rectangular type to the most elaborate of ornamental forms, and afford large opportunity for effective decoration, as will be appreciated by examining the illustrations in Part V.

No other embellishment of the entrance doors of a handsome store is so effective as a pair of handsome plates and handles, of appropriate design, and this fact is so well understood that it is

not uncommon for an outlay of from \$25 to \$50 per door to be incurred for this purpose.

• The convenient action of the store door lock and latch, with handles and thumb-pieces, has of late led to its extensive use in office buildings as a substitute for the knob lock on corridor doors.

## Section 13.

### Lock "Trim" and Lock "Sets."\*

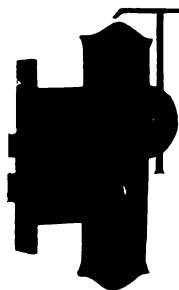

THE term Lock, as used in the trade, includes only the lock itself, with its keys, the strike, and, usually, the screws for attaching. Any other parts required, such as knobs, escutcheons, etc., are separate items, and are designated collectively as the "trim," or by the older term "furniture."

From the outset most of the Yale locks were packed each in a paper box, complete with screws (which was then an innovation,) and all necessary trim. The practice thus inaugurated was followed later by other lock-makers, and has grown so that it is now customary to pack many kinds of locks in this way. When so packed each constitutes what is termed a "lock-set." Obviously this practice can be applied regularly only to staple goods, as the possible combinations of locks and trim are too vast in number for all to be so treated, but practically the same result is reached as to locks and trim selected by Architects, by putting each lock, with its trim, in a separate package, labeled for the place for which intended.

In the case of Rim locks the usual trim consists of a pair of knobs with knob-roses and key-plates, although combined escutcheons may be substituted for the two latter pieces.

In the case of Mortise locks the trim consists, almost invariably, of a pair of knobs and a pair of escutcheon plates, although there is a tendency in some cases, especially where glass

\*For detailed information see Part V, "Locks in Sets."

knobs are used, to revert to the older style of knob-roses and separate key-plates or drop-escutcheons.

Except where plain trim is used the selection of trim involves the element of decoration, and this is fully discussed elsewhere, but whether plain or ornamental trim is used the range of quality is a *very* wide one, and the opportunity for intelligent selection correspondingly great. Information on this point is given under the head of "Metals and Finishes," Part III, Section 7, but in addition to what is said there, attention is called to the great divergence in sizes and in weight of material, especially in the case of wrought metal goods, and the resulting variations in cost. In comparing competitive quotations all these factors should be considered, and therefore an intelligent decision can usually be reached only by an inspection and handling of correct samples of the several articles.

For minor work, especially small residences, the commercial lock-sets carried in stock by dealers can be availed of, and will be found to include goods of fair quality, although much of the so-called commercial line consists of light-weight and inferior goods, but for all important work Architects should avail of the far larger assortment of finer and choicer designs included in the catalogues of leading manufacturers, any of which can be supplied by any responsible dealer, and thereby secure a much wider range of choice and of individuality.

## Section 14.

### Hand and Bevel of Doors.



**M**ANY years ago The Yale & Towne Manufacturing Company, finding that no absolute rules then existed whereby to determine the "hand" of doors, formulated, adopted and published the following rules relating to hands and bevels, which, having since been adopted generally by other manufacturers, may now correctly be said to be the established standard of the trade.

Some locks and some butts are available for both right and left hand doors; others are not, and so must be specified as right hand and left hand. In the latter class are loose joint butts, and most locks the operation of which is different on one side from the other, such as front door, hotel and office locks, certain room door locks with thumb-bolts, and nearly all master-keyed locks.

#### RULES.

1. The hand of a door is always determined from the *outside*.
2. The "outside" is the street side of an entrance door, the corridor side of a room door, and the room side of a closet door. The outside of a communicating door, from room to room, is the side from which, when the door is closed, the butts are *not* visible. The outside of a pair of twin doors is the space between them. This rule applies to *sliding* doors as well as to doors hung on hinges.





Fig. 2.



Fig. 1.



Fig. 4.



Fig. 3.

- Fig. 1. Right hand Door opening *in*; takes right hand lock *regular* bevel.  
 " 2. " " " " *out*; " " " " *reverse* "  
 " 3. Left hand Door opening *in*; takes left hand lock *regular* bevel.  
 " 4. " " " " *out*; " " " " *reverse* "



Fig. 5.

3. If, standing outside of a door, the butts are on the right it is a right hand door, if on the left it is a left hand door.

4. If, standing outside, the door opens from you, or inward, it takes a lock with *regular bevel* bolt, and if opening outward it takes a lock with *reverse bevel* bolt.

5. A door is "beveled" when its edge is not at a right angle with its surface, and in this case the front of a mortise lock must be beveled to correspond. This bevel is expressed by stating the thickness of door and the distance which one edge drops back of the other. The standard bevel is  $\frac{1}{8}$  inch in  $2\frac{1}{4}$  inches. (Fig. 5.)

6. The bevel of a lock is a term used (both with mortise

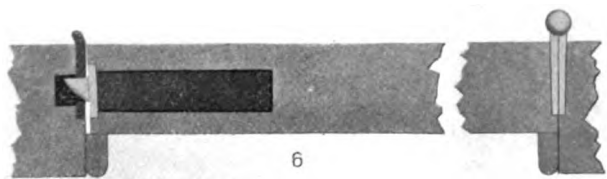

Fig. 6.

and rim locks) to indicate the *direction* in which the bevel of the latch bolt is inclined. If inclined outward, as for doors opening inward, it is a *regular bevel* (Fig. 6); if inclined inward, as for doors opening outward, it is a *reverse bevel* bolt. (Except as to Cabinet Locks, which, being commonly used on doors opening outward, are regularly made with reverse bevel bolts, unless otherwise specified).

Mortise locks used with double doors having either *rabbeted* or *astragal* joints require to have fronts of corresponding sectional form. To avoid the extra cost of special patterns the edges or



Fig. 7.

joints of such doors should conform to established lock standards. The standard rebate is *one-half inch*, as shown by Fig. 7, and the



Fig. 8.

standard astragal joint has a *three-quarter inch* bead (the groove to receive it being slightly larger) as shown by Fig. 8.

The proper bevel of a door, if any is needed, is determined by the size of butt and the width of door, as shown by Fig. 9. The inner corner B of the door travels on the radius A B, and must have a clearance equal to the *versed sine* of the arc B C. This may be obtained by beveling the edge of the

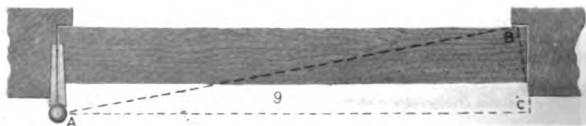

Fig. 9.

door or, if its edge is left square, by leaving sufficient clearance between the door and its jamb. If the door is of fair width, and if the butt does not need to be very wide, (to clear the architrave), it will be found that a square edge may be used without resort to an unduly open joint, thus permitting the use of a lock with regular front, (i. e. *not* beveled). The use of beveled front locks should be avoided where no real need for them exists.

This depends on the relative positions of the points A, B and C, and by plotting these the question can be settled definitely, and better than by leaving it to the varying judgments of contractors or their workmen.

A "reversible" lock is one having a beveled latch bolt which can be turned over, or "reversed," to make its bevel face in

the opposite direction, and thus to convert it at will to either a right hand or a left hand lock. Formerly many locks were made with a "slide reverse," that is so that, by sliding some piece (or the bolt itself) while the lock was in hand, the bolt could be turned over quickly. All devices of this kind tend to weaken and complicate the lock, for a trivial and transient convenience, and have generally been abandoned, except in cheap rim locks. The reversing of the bolt, where desirable, is best accomplished by removing the cap of the lock, and locks so made are said to have a "cap reverse."

The strike of a *mortise* lock is the same whether for regular or reverse bevel. In the case of a *rim* lock, however, the two are quite different, as will be seen from the accompanying illustrations of a rim night latch, Figs. 10 and 11.

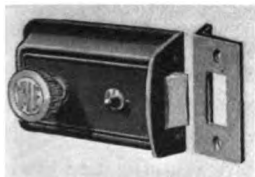

Fig. 10.

Right hand door, opening *outward*;  
requires *reverse* bevel bolt and strike.

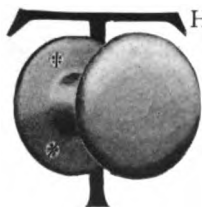

Fig. 11.

Right hand door, opening *inward*;  
requires *regular* bevel bolt and strike.

## Section 15.

### Knobs and Spindles.



THE Knobs used with Builders' Locks may be broadly classified as follows :

**POTTERY KNOBS.**—These have tops made of clay, the *three* usual kinds being designated as “Mineral,” a tawny brown, irregularly striped ; “Jet,” a deep black ; and “Porcelain,” a pure white ; all highly glazed.

The “mountings” (*i. e.* shanks and roses), are usually of cast iron or plated steel, but may be of real bronze or brass. Such knobs are used only with the cheapest grades of locks and are seldom called for by Architects.

**WOOD KNOBS.**—These have tops of various kinds of hard wood, in natural finish, with “mountings” of any metal desired. Although considerably in vogue during the “East-lake” period of earlier years they are now but little used except in buildings of the cheaper class, probably because the contrast they offer to the wood of the door on which used is less pleasing and effective than that of metal or glass knobs.

**CAST IRON KNOBS.**—These are largely used with cheap locks, and are usually ornamented. They are serviceable but rarely attractive, and are not often used by Architects. An exception is a heavy knob, entirely plain, finished by the Bower-Barff process, well made and often used on good work.

**COMPOSITE (BUILT-UP) METAL KNOBS.**—This is a large class which has come into very extensive use, and which includes some very good, but more indifferent, kinds. The motive in all cases is to use a cheap material (iron or steel) for the main

structure and to cover this, wholly or in part, with a veneer of bronze or brass. Too frequently quality is sacrificed to cheapness and the result is a very poor knob. The variations are many, but a safe method of selection consists in sawing a knob in two (which can quickly be done with a common "hack-saw" by any dealer or locksmith) and in then examining its structure. No expert knowledge will be needed to detect the trashy article by this plan. There are some composite knobs, however, which are thoroughly good and can properly be utilized in many places. Many of the cheaper bronze knobs used with commercial lock sets have a cast iron shank covered with a thin bronze "skelp" or veneer.

**REAL BRONZE AND BRASS KNOBS.**—These constitute the best grade of door knobs, and are always used in buildings of the better class. All ornamental knobs of the higher grades are of this kind. Differences in weight and finish exist and should be noted. The best knobs of this kind are usually "Solid," that is cast in one piece, (except that the shank may be inserted), but others are made in two pieces joined together in various ways. If this is well done the knob may be good, but the solid knob is to be preferred. An exception, in the case of plain knobs, is the construction employed in the Yale & Towne No. 56 knob (see Part VI), which consists in the use of an interior shell or frame of wrought steel, over which is tightly drawn an external skin or covering of wrought bronze (or brass) of substantial thickness, the completed knob being actually stronger than a cast knob, and much more resistant to bruising or other injury. In this case the composite knob is even better than one of cast metal and costs as much.

**GLASS KNOBS.**—These have glass tops with metal mountings. If properly made they are very handsome and somewhat expensive, this depending, however, on the style and amount

of cutting. If of plain pressed glass the cost is moderate, but much finer effects are obtained with cut glass and prices vary accordingly.

The old method of mounting the glass top was very clumsy and provided no means for adjusting the knob to doors of varying thicknesses, each knob being riveted to its spindle. Some years ago the Yale & Towne Manufacturing Company devised means for overcoming these objections, and introduced the line of glass knobs shown in Part VII, the essential features of which have since been reproduced by other makers. In this form glass knobs are as available and reliable as any others, and in appropriate places are very handsome and effective, especially in connection with work in the Colonial School.

If used they should be selected and specified with care in view of the great difference in quality and prices which exists.

**LOCK SPINDLES.**—Knobs are always priced by the *pair*, and a pair of knobs always includes the spindle which connects them with each other and with the lock.

Until lately all lock spindles were of the type shown by



Fig. 1. Solid (or Side-Screw) Spindle.

Fig. 1, and this form, known as the "common" or "side-screw" spindle, is still in almost universal use, although a crude and unsatisfactory device. One knob, or both, is secured to the spindle by a side-screw passing through a hole in the knob shank and engaging with the one of the threaded holes tapped in the spindle which happens to come nearest to the proper adjustment, the remaining adjustment being accomplished by placing one or more thin "washers" under the end of the knob shank.

The general looseness and rattle of this crude device, and the provoking tendency of the side-screw to work loose and drop out, are annoyances so familiar and long-established that they have been regarded as unavoidable evils. They are no longer such, however, and no specification for hardware should fail to bar them out.

As far back as 1878 the Yale & Towne Manufacturing Company attempted to solve this problem and coined the word "screwless" to designate the improved spindle which it then brought out. This first device, however, proved unsatisfactory and was withdrawn. Experiments were continued to find a satisfactory method, with the result that a thoroughly good

screwless spindle and knob was perfected and put into use about 1881. This consisted of a chuck or vise formed on the knob-shank which, when tightened with a wrench, gripped the spindle securely, the latter being solid and without screw holes. While mechanically perfect, and still used when a customer is willing to pay a little more in order to have the very best article, this "clutch-knob-shank" was too

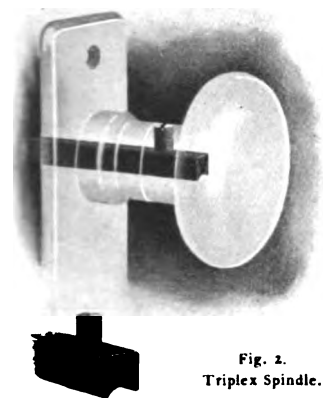

Fig. 2.  
Triplex Spindle.

expensive for general commercial use. Therefore experimentation was again resumed, with the result that in 1890 the Company brought out the patented "Triplex spindle," (Fig. 2), now used with almost its entire line of locks and knobs, and furnished at equal price with the old "common" spindle.

As shown by Fig. 2 the Triplex spindle consists of three



parallel bars, which together form a square rod. A set screw in the knob-shank bears on the center bar, and the wedge form of this forces the two other bars apart and into frictional engagement with the knob. The spindle itself is "screwless," and no tendency exists to loosen the set screw, so that when once properly tightened it will so remain under all conditions of use.

The Triplex spindle, like other improvements in the mechanic arts, has been opposed by ignorance and prejudice, but it has long since passed the experimental stage and demonstrated its value, more than ten years having elapsed since it was first introduced, and many millions being now in successful use. It is the only device which, without increased cost, has successfully overcome the defects and annoyances of the old type of side-screw spindle.

**THE SWIVEL SPINDLE.**—This is a spindle used with Front Door and Vestibule locks which have a "stop-work" whereby at will the outside knob may be made operative or not. To accomplish this the spindle is divided longitudinally, so that one end may rotate independently of the other, as shown by Fig. 3.



Fig. 3. Triple (Swivel) Spindle.

**SIZES OF SPINDLES.**—There are two standard sizes of lock spindles, known as the  $\frac{5}{16}$  and  $\frac{3}{8}$  inch sizes. These dimensions, however, indicate the size of the holes in the lock hubs, through which the spindles pass, the actual sizes of the spindles being respectively .28 and .36 inch. Spindles of  $\frac{1}{4}$  inch size are used for thumb knobs, and of  $\frac{1}{2}$  inch size occasionally for very large knobs or handles. Swivel spindles should not be smaller than the  $\frac{3}{8}$  inch size.

## Section 16.

### Butts.



THE field of Hardware no article deserves more consideration, and receives less, than the Butt or Hinge. It carries the whole weight of a door and is in constant use, the resulting friction of its parts and the varying strains to which they are subjected all tending to produce wear and disturbance.

Therefore, butts of proper size and quality should always be used, and economy, if needed, be sought elsewhere than in the use of cheap and inferior butts, of which, unfortunately, there are many. The various kinds available are as follows :

**CAST IRON BUTTS.**—These are the cheapest and least durable, and should only be used where economy in first cost is the controlling factor. They are made in all finishes, including bronze plate, the latter being difficult to distinguish from solid bronze. A heavy cast iron butt, of good quality, is also made for use where the Bower-Barff finish is desired.

**WROUGHT STEEL BUTTS.**—These are excellent mechanically, and are thoroughly appropriate for a wide range of uses. The material insures strength and durability, and adapts itself to all kinds of finishes, especially to bronze plating. Steel butts are made in various qualities and of different thicknesses, so that care is needed in selecting and specifying them. They are especially available where the Bower-Barff finish is desired.

**CAST BRONZE (AND BRASS) BUTTS.**—These constitute pre-eminently the highest grade of butts, and are nearly always

adapted for important work, except where the Bower-Barff finish is wanted, in which case a heavy cast iron butt or a steel butt is substituted. No other article offers so much temptation, and so much opportunity, for departure from specifications as a bronze or brass butt, because of the great range in quality and the difficulty in determining the quality after a butt has been put into position.

Competition in prices has reduced the thickness of metal in the commercial bronze butt to a degree which has led to the nicknames "razor-edge" and "brown-paper" to designate the attenuated article, and rigid specification and inspection are needed to guard against the substitution of these for butts of proper weight and quality, but with these precautions no difficulty exists in obtaining good bronze and brass butts. These are of two grades, the heaviest and best being represented by Y. & T. No. 750 (Fig. 5, page 178), and the second by Y. & T. No. 780 (Fig. 6,

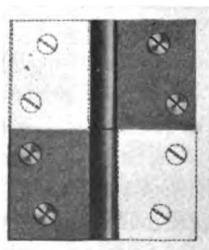

Fig. 1.

page 178). The first of these should be availed of for all important work, while the second is appropriate elsewhere, and, being lighter, is somewhat cheaper. *No lighter or inferior grades should ever be used.* If further economy is desired the steel butt, bronze or brass plated, should be availed of and is far better than a "razor-edge" cast bronze butt.

Ornamented butts involve considerable extra cost, the ornament is little seen and not effective, and their use has wisely been abandoned.

Butts vary in mechanical construction as well as in material, the leading types being as follows :

**LOOSE Joint BUTTS.**—As the name implies, these can be

slipped apart, and a door hung on these butts can be lifted off its hinges when open. This is practically the primitive hinge,

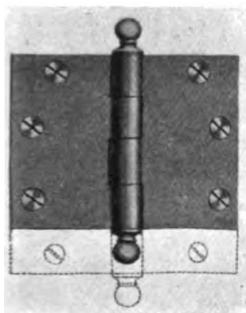

Fig. 2.

represented by the shaded part of Fig. 1 on opposite page, with the unshaded part added for symmetry and to give room for more screws. Each butt presents only *one bearing* to carry the weight of the door and receive the resulting wear, the pin being fast in the lower part. They are cheaper but not so good as butts with more bearings. They are *not reversible*; that is, a right hand form

and a left hand form are both required. This is the cheapest style of butt hinge, and its use is limited accordingly.

**LOOSE PIN BUTTS.**—In these the pin is loose and can be withdrawn to permit the door to be unhinged, thus making them the most convenient to apply and to use.

Obviously either leaf is equally capable of supporting the other and hence this butt *is reversible*; that is, the same form answers for both right and left hand use. They should always have at least *five* knuckles as shown by the dotted lines in Fig. 2, and by Fig. 3, in order to have *two* bearings, whichever is the supporting leaf. Some cheap loose-pin butts have only four knuckles, as shown by the shaded part of Fig. 2, but

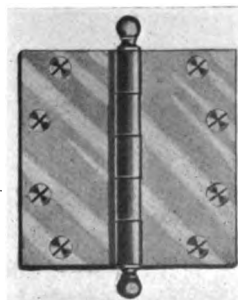

Fig. 3.

these are no better than three knuckles, as in either case only *one* bearing is assured.

The loose-pin butt is the type now generally used for all purposes. A troublesome feature heretofore has been the tendency of the loose pin to "creep" up, which, although rarely involving danger, is unsightly. Some years ago the Yale & Towne Manufacturing Company introduced a "hold-fast" pin which remedies this fault. As similar devices have since been adopted by other makers no difficulty exists in obtaining butts with this improvement, which entails no extra cost, if insisted on. All Y. & T. butts of the better grades have the "holdfast" pin. These butts always have "tips," to enable the loose pin to be withdrawn.

**FAST JOINT BUTTS.**—These, as shown by Fig. 4, resemble the butts just described, except that the pin, instead of being loose, is permanently riveted in, so that in order to unhinge a door one leaf or the other must be unscrewed from the wood. Owing to this inconvenience they are now very seldom used, except for cabinet work.

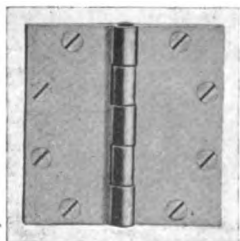

Fig. 4.

Other special forms of butts are made to meet special conditions, illustrations of which will be found in Part VI. Standard butts for Builders' use are always *square*, that is the height and width of the butt, when open, are equal. When greater "throw" of the door is needed, (in order to clear a heavy trim or architrave), either a larger butt must be used or one of irregular size, with greater width than height, at some extra cost.

In butts, as in locks and nearly all other Hardware, where two dimensions are given the first always indicates *height* and the second *width*. Thus a 5 × 6 inch butt is 5 inches high by 6 inches wide.

Various devices have been adopted to diminish the friction and wear on the bearings of butts, and thus to prevent the resulting sagging of doors and need of readjustment of the butts after long use. All good butts made of bronze or brass are "steel bushed;" that is, provided with steel washers to resist the wear. If these are well made they are effective, but some of them are shams. The best, as in the Y. & T. butts, are "self-lubricating," being provided with pockets which contain a permanent lubricant. A later, but expensive improvement consists in a "roller-bearing," which can be introduced in any good butt if called for, but which as yet has not been largely used.

In selecting and specifying butts, next to reliance on the name and repute of the maker, the chief point is to make sure of obtaining the proper weight and strength. This can best be done by the use of catalogue numbers, but when this is deemed inexpedient the *weight per pair* should be specified. The difference in this respect, between butts of various grades, is shown by Figs. 5, 6 and 7, on next page, 178, which are introduced to emphasize the statement previously made that rigid specification and inspection are more necessary in the case of butts than of any other item of Builders' Hardware. The weights there given are per pair of 5 × 5 inch butts, without screws.

All doors require at least one pair of butts, that is two hinges. On doors over 7 feet high or 4 feet wide three butts (1½ pair) should be used, and they are desirable even on smaller doors. The size of butts depends upon the size and weight of door and the number of butts used. The 4½ and 5 inch sizes are those chiefly used for ordinary interior doors, and the 5 to 6 inch sizes for entrance doors.

Strap or surface hinges are now very seldom used, except for

doors of unusual size or weight, because the butt-hinge (technically called a "butt") is mechanically better. Where the architectural effect of a strap hinge is desired, as for example on church doors, it is obtained by using butts of the proper size to carry the door and supplementing them with surface "hinge-plates," for examples of which see Part VII, Section 2.



Fig. 5, Y. & T. No. 750. Weight 4 lbs., 5 oz. Full Size Section of 5x5 inch Butt.



Fig. 6, Y. & T. No. 780. Weight 3½ lbs. Full Size Section of 5x5 inch Butt.



Fig. 7, "Razor-edge." Weight 2 lbs., 4 oz. Full Size Section of 5x5 inch Butt.

Weights given in all cases are per pair, without screws.

## Section 17.

### Door Bolts.

**T**HESE are chiefly used with double doors, to secure the standing leaf or part. Where desired on a single door it is usually preferable to avail of a "three-bolt lock" (see Part IV) which includes a thumb bolt in the same case as the latch bolt and dead bolt. The leading types of bolts are as follows :



Fig. 1.

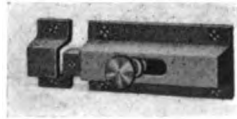

Fig. 2.

**RIM OR SURFACE BOLTS.**—These are not often used except on cheap work. They are of various kinds with round, square and flat bars, boxed and open, and of many sizes, styles and prices. Figs. 1 and 2 are indicative of the type. They are suitable for minor uses, and especially for cabinet work.



Fig. 3.

**FLUSH BOLTS.**—These are intended to be sunk into a door flush with its edge or surface, and, when not required to be more than eight or ten inches long, are appropriate in many places.

They may be operated by a flush slide, as in Fig. 3, by a knob, or by a pivoted lever, similar to that shown in illustration of Extension Bolt, Fig. 4, which is a greatly improved form recently introduced by the Yale & Towne Manufacturing Company and since adopted also by other makers.

**EXTENSION BOLTS.**—This is the latest and best





Fig. 4.

A variety of bolts for special purposes is made, illustrations of which will be found in Part VI, and an examination of these will be found useful in considering the best method of fastening doors of irregular construction. Under this head may be mentioned Dutch doors, screen doors, book-case doors, etc.

form of bolt for large doors and the one which should always be preferred where considerable length is required, because cheaper than a flush bolt of equal length, and still more because it avoids the disfigurement of the door which a very long flush bolt involves.

Where used on the edge of the door it must be operated by a flush slide (similar to that shown in illustration of Flush Bolt, Fig. 3) or preferably by the lever arrangement shown by Fig. 4, but when applied to the inside face of the door it may be operated by a knob or, if of large size, by a turn handle, as shown by Fig. 5.

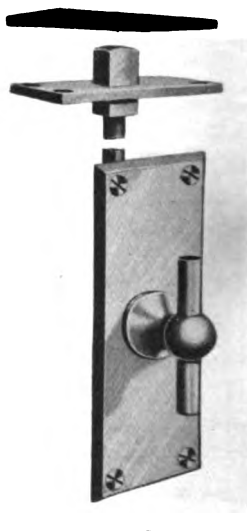

Fig. 5.

## Section 18.

### Sash Trim.



Fig. 1.

COMMONLY used this term covers the hardware for sliding sashes, (known in continental Europe as *sashes à guillotine*), that for hinged sashes falling under the head of "casement" trim. The principal items of sash trim are as follows:

#### SASH (OR FRAME) PULLEYS (Fig. 2).—

These are of the general type shown by illustration, and should be included in the specification for window frames and furnished, in place, with the latter. They are of many kinds and grades and can best be selected by *examination of samples*. The common grades are rough and cheap, but answer fairly well for light sashes hung on cords. For large sashes, however, of plate glass and hung on chains, pulleys of larger size and better construction are essential and should be specified. Smoothness of motion is increased by requiring the pulley to be *turned*, and ease of motion by the use of those with anti-friction roller bearings. The face of the pulley box, or housing, is usually of iron or steel, intended to be painted with the window frame, but for fine work a pulley with bronze face is often used, the whole construction being of proportionately higher grade and cost.



Fig. 2.

SASH CORD, CHAIN AND WEIGHTS.—These are all usually covered by the Carpenter Specification, under the head of "Rough Hardware." The cord and chain should be specified both as to size and make, as they exist in various grades.

Where lead weights are necessary, to economize space, attention should be called to the fact in the specification.



Fig. 3.

**STOP-BEAD SCREWS** (Fig. 3).—These may be covered either by the Carpenter or the Hardware specification, but are usually included in the latter to ensure harmony of finish with other metal work. The kinds usually employed are shown by illustration, the choice between them being largely a matter of taste.

**SASH LIFTS** (Figs. 4, 5 and 6).—These are now almost invariably used, even in cheap buildings, and with large single-light sashes are a necessity.



Fig. 4.

The simplest form is the Hook sash lift shown by Fig. 4, which is serviceable

but not decorative. A better form, and

the one most generally used, is the Flush sash lift, shown by Fig. 5 and made in great diversity of sizes, shapes and styles. A third form is the Bar sash lift, shown by Fig. 6, which is the



Fig. 6.

most convenient in use, especially for very heavy sashes, such as used in public and commercial buildings.



Fig. 7.

**PULL DOWN HANDLES** (Fig. 7).—Two of these are frequently attached to the under side of the bottom rail of the upper sash; for use in pulling it down, illustration

shows the style usually employed, although for very large sashes a plain bar-handle is sometimes preferred.

**SASH-SOCKETS AND PULL DOWN HOOKS** (Fig. 8).—Another plan for operating the upper sash consists in inserting a metal “socket” in its top rail, and providing a “hook,” mounted on the end of a wooden rod of suitable length, whereby the sash may conveniently be moved in either direction.



Fig. 8.

**SASH FASTS** (Figs. 9, 10, 11 and 12).—Of these there is a great diversity and, therefore, corresponding need of intelligent selection. They have three functions, viz: (1) to furnish protection; (2) to reduce air leaks; and (3) to prevent rattling. To accomplish the first the construction must be such that the Fast cannot be opened by any instru-

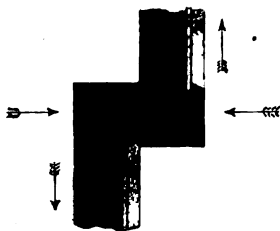

Fig. 9.

ment inserted between the sashes, and all good Fasts are now so made. The other two functions imply that the two sashes must be drawn tightly together horizontally and, at the same time, be pressed in opposite directions vertically, so as to force their ends against the window frame at top and at bottom. The direction of these forces is indicated by the arrows in Fig. 9, and their resultant is obviously the diagonal A-B. Therefore, the more nearly the “pull” of a Sash Fast coincides in direction with this line, and the greater the pressure it develops, the better will it serve its purpose.

Unquestionably the Fast which best fulfills these conditions is the Yale Screw Sash Fast shown by Fig. 10, on following page, in

which the tightening of a thumb-nut on a fine-pitch screw develops strong pressure exactly in the desired direction. The



Fig. 10.

great pressure which it develops involves a few moments longer time to operate than Fasts which exert little or no pressure on the sashes, but this constitutes no practical objection.

The next best type is that shown by Fig. 11, in which a helical cam on the lower sash engages with a lug on the upper sash in a manner tending at once to draw the two sashes together horizontally and to force them in opposite directions vertically. While this Fast thus acts in the right *direction* it is much weaker in *power* than the one above described, but it operates more *quickly* than the latter. This type is best known by the names of its earlier makers, Ives and Fitch, but it is now made by many others.



Fig. 11.

Another standard type, still preferred in some localities, is the so-called "Boston" Sash Fast shown by Fig. 12. This is neat in appearance and convenient in action, but otherwise has little to recommend it as it does not develop much pressure, and even this is not right in direction.



Fig. 12.

Still another device is the Sash *Lock* shown by Fig. 1, (Yale & Towne No. 914), whereby the sash may be locked in any desired position and can only be released by means of the key.

The many other varieties of Sash Fasts are usually of inferior design and cheaper construction. Other special appliances for securing sashes are described in Part VI.

## Section 19.

### Casement Trim.



Sliding, or "double-hung," Sash prevails almost universally in Great Britain and her Colonies, and in the United States. In other countries the Casement, or hinged sash, is in universal use and the sliding sash seldom seen.

While the term "Casement" applies properly to any hinged sash, it is usually limited to those which have a sill raised some distance above the floor, the term "French window" being applied to those which extend down to the floor level. The same trim is available in either case.

In Europe a casement window usually has a transom at about one-fourth or one-third the distance from the top, the space below being closed by two main sashes, fully trimmed, and the space above being closed by two smaller sashes which are sometimes hinged at side or bottom, but more frequently fastened permanently in place. In France the sashes almost invariably open inward; in Germany they more commonly open outward.

Experience in European countries has developed methods of framing which best tend to make casements weather-tight, these in turn affecting the details of the hardware, and this experience should be utilized in designing hinged sashes for use here, in doing which the designer should consider both the wood-work and the hardware, and their relation to each other. (See Part X, Section 10 for methods of Casement construction.)

**HINGES.**—To secure a tight vertical joint the axis of the

hinge should be as close as possible to the surface of the casement, and preferably a little outside of its lateral edge. If the vertical joint of the casement and its frame is square, or is undercut on the French plan, regular butts, such as used on doors, are available, but should be narrow in order to bring the axis close to the surface of the sash. The German plan (illustrated in Part X, Section 10) involves the use of a special butt, the axis of which is about one-half inch back from the joint, thus enabling the vertical edge of the sash to be deeply undercut to form a tighter joint.

**BOLTS.**—Any good form of bolt can be used on hinged sashes at the top and bottom, and may be supplemented by a good latch or cupboard catch at the centre, but in the countries where such sashes are regularly used the necessary fastenings have been consolidated into a single structure, the two leading forms of which are described below, the action of one being vertical and of the other rotary.

**THE CREMORNE BOLT** (Fig. 2).—This device consists of a vertical rod, in *two* pieces, divided at or about the middle of its length, operated by a knob or handle at that point, the turning of which by the hand causes the upper and lower ends of the rod, or bolt, to slide vertically, but in opposite directions, and thus to engage with suitable strikes, either of the plate or box form, attached to the window frame at the top and bottom. The ends of the

Fig. 2.

Fig. 3.

bolts being beveled, their motion presses the two sashes tightly together and against the sash frame, a single movement of the knob sufficient to fasten or release both bolts. For very high sashes a supplemental fastening at the centre may be obtained by providing a projecting spur on the bolt which engages with a tapered hook on the opposite sash.

**THE ESPAGNOLETTE BOLT** (Fig. 3).—This also consists of a vertical rod, put in *one* piece and provided with hooks on its ends to engage, by rotation, with pins or plates in the window frame and thus draw the sashes together and against the frame. It is usually operated by a pendent handle, by which, when lifted to the horizontal position, the rod can be rotated to fasten or release the sashes. For very high sashes a supplemental fastening at the centre may be obtained with this device also by providing a tapered hook on the opposite sash for the pendent handle to engage with, thus supporting it in a horizontal position when the sashes are closed.

The Espagnolette bolt is more expensive, and usually heavier, than the Cremorne, and exerts more power than the latter in forcing the sashes against their frame, for which reason it is somewhat to be preferred, especially for large sashes and doors. Both forms are available for use on *doors*, as well as on windows, and in Europe are extensively so used, especially on entrance doors. Both also lend themselves admirably to decorative treatment, and can be made very effective as elements of ornament. Numerous examples of them are illustrated in Part VII.

**CASEMENT ADJUSTERS** (Fig. 4, page 188).—These are devices for holding and fastening a casement sash (whether hinged or pivoted) in any desired position. One of them is shown by the illustration as applied to a pivoted casement, but they are made in various styles, for sashes which open inward, for those



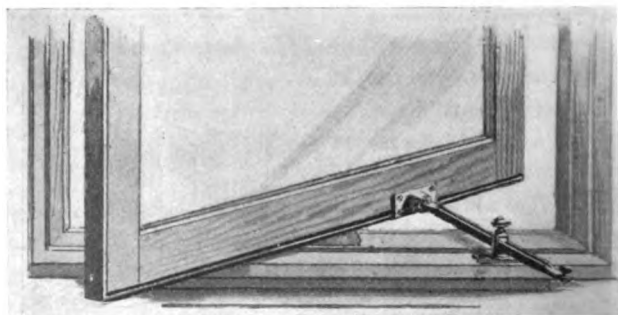

Fig. 4.

which open outward, and to conform to different constructions of the sash and frame. They consist essentially of a rod or bar, attached to the sash by a hinged or pivoted joint, connecting with a clamp on the frame or sill whereby the bar, when the clamp is tightened, holds the sash in any desired position. Illustrations of Casement Adjusters will be found in Part VI.



Fig. 5.

CASEMENT FASTS (Figs. 5 and 6).—These comprise various devices for fastening one hinged sash to another or to its frame. The two leading types are shown by Figs. 5 and 6, the former illustrating a



Fig. 6.

*mortise* and the latter a *rim* fast. Other varieties are illustrated in part VI.

## Section 20.

### Shutter Trim.

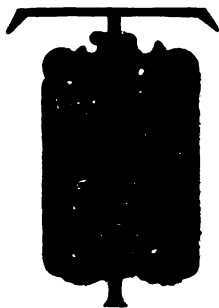

Fig. 1.

THE general use of the *inside* shutter or “blind” in the older parts of this country has developed hardware for use therewith.

**BUTTS.**—Three kinds of these are used, according to the number of “folds” in the shutter, and the manner in which they are intended to fold back on each other, viz.: a regular butt (usually fast joint); a back flap, and, where the shutter has three folds,

an angle butt, the purpose of which is to cause the folds to take such relative position as will enable them, when open, to close properly into the pocket or recess of the window frame. These several kinds of butts are illustrated by Y. & T. Nos. 150, 50 and 60.



Fig. 2.

**SHUTTER BAR** (Figs. 1 and 3).—This is a bar pivoted to a plate attached to one leaf of a shutter, and engaging with a stud or hook on another plate attached to the opposite leaf, thus holding the shutters closed (see Fig. 3). Provision is, or should be, made at one end of the bar to allow for the shrinking and swelling of the blind, which is often considerable, because of the amount of wooden surface, and its exposure to sunlight and weather. Shutter bars



Fig. 3.

are made in great diversity of size, style and quality. As they are little seen a plain, substantial pattern is to be preferred, but they are also made in ornamental designs (see Fig. 1). In the case of blinds having three folds provision must be made, by use of the proper butts, to obtain space for the shutter bar when the blind is folded together, or else a *flush* shutter bar must be used (such as Y. & T. No. 1385).

**SHUTTER KNOBS.**—These are needed to withdraw a shutter from its pocket, and, being prominent, should be substantial and handsome, but not necessarily decorated, even where the larger hardware is of ornamental character.



Fig. 4.

The simplest form is shown by Fig. 4, and is without base or washer, but the better form includes a base, as shown by Fig. 5, and is always to be preferred, especially as the difference in cost is

small.

The use of the *outside* shutter, universal in the case of the typical New England farm house, is still quite common, especially in country houses of the Colonial type, and a great variety of special hardware is made for use therewith.



Fig. 5.

Shutter butts are made both of wrought and of cast iron, the latter being usually the best, but care is needed in their selection, as most of them are of very cheap and flimsy construction.

As the outside shutter is usually slatted, for ventilation, its fastenings are not intended for protection, but merely to hold it in the closed or open positions. A variety of catches and "fasts" are made for this purpose, but the most convenient are those which secure the shutter in the closed, open and several intermediate positions, among the best fixtures for this purpose being those made by G. F. S. Zimmerman & Co., Frederick, Md. Another available device is a simple casement adjuster,

such as Yale & Towne's No. 2386, and still another, the "shutter worker," made by the Mallory Manufacturing Co., Flemington, N. J.

An increasing tendency exists to substitute for either inside or outside shutters the so-called "Venetian blind." If of the inside type this is operated by cords; if of the outside type it is held in a metal or wood frame (usually arranged so that the blind may be inclined outward from the window at the bottom). In either case no hardware is required.



Fig. 1. Top Hung.

Fig. 2. Centre Hung.  
Types of Eransom Lifts.

Fig. 3. Bottom Hung.

## Section 21.

### Transom Trim.

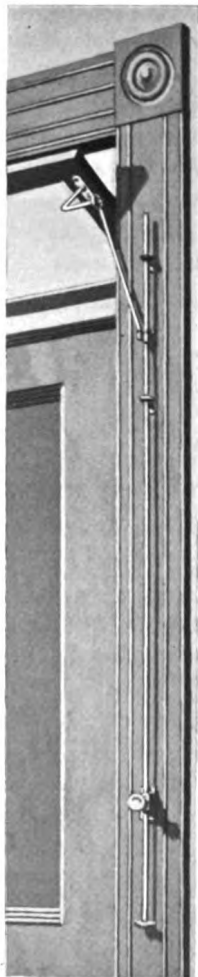

Fig. 4.

THE use of a Transom Light over bedroom doors is peculiarly an American custom, which many think would be better honored by the breach than the observance, because interfering with the control of light within the room at night, and, as a ventilator, because serving more often to ventilate the hall into the room than to improve the air of the latter.

Their largest use is in hotels, but they are legitimately needed elsewhere under certain conditions, and, where used, require special hardware.

**TRANSOM LIFT** (Figs. 1 to 7).—This is a distinctly American device for operating and fastening transom lights, and was first made by Wollensak, of Chicago, but is now made by nearly all leading manufacturers of Builders' Hardware, as well as by others. It consists essentially of a vertically sliding rod on the door jam, with an arm at the top connecting it with the sash, and a clamp or "grip" (see Figs. 5 and 6) near the bottom, to hold it in any desired position. Vertical movement of the rod causes the sash to swing, the latter being hinged at the top (Fig. 1), centre (Fig. 2), or bottom (Fig. 3) as preferred. The several makes are substantially alike, except for variations in the form of clamp, but the range of size and quality is large, and corresponding care is needed in selection and specification, especially as to size.

The commercial article is made of steel, copper or bronze

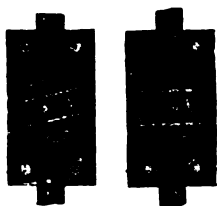
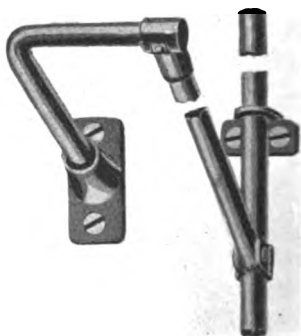

Fig. 5.                      Fig. 6.  
When Locked.    When Unlocked.  
Position of Grip.



plated, and in  $\frac{1}{4}$  and  $\frac{5}{16}$  inch sizes. The better grades are made of bronze or brass rods, and in  $\frac{5}{16}$ ,  $\frac{3}{8}$  and  $\frac{1}{2}$  inch sizes. The size should be determined by the size of transom light and length of rod, but properly should

never be less than  $\frac{5}{16}$  inch. For further information see

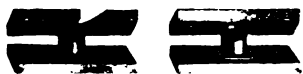

Fig. 8.



Fig. 9.

#### Part VI.

SASH CENTRES (Figs. 8 and 9)—Where a transom sash is hung at its top or bottom, regular butts,

of proper size, can be used. Where it is "centre hung," however, as in Fig. 2,



Fig. 7.

pivots are needed which are termed "sash-centres." The usual form of these is shown by Fig. 8, but a better form is shown by Fig. 9, which is termed a Rabbeted centre, its construction giving greater strength, and completely closing the joint against light. They are of bronze, and of various sizes.

#### TRANSOM CATCHES (Fig. 10).—

These are spring catches, or bolts, of various forms, but all having a ring or eye in the handle from which a cord may be suspended or into which a "pull-down hook" (see page 183) may be inserted to operate the sash.



Fig. 10.

#### TRANSOM CHAINS (Fig. 11).—

These are not needed where a Transom Lift is used, being merely a short length of chain, with an attaching eye or plate at each end, applied so as to limit the opening or swing of a transom light when hinged at the bottom.



Fig. 11.

FAN-LIGHT FIXTURES.—A transom light with semi-circular top, termed a fan-light, may be hinged at the bottom or pivoted on its vertical

axis. In either case it is somewhat troublesome to operate, and requires special fixtures, information concerning which can best be obtained by applying to the manufacturer and furnishing the latter with a sketch or description of the fan-light and its surrounding trim.



## Section 22.

### Minor Fastenings.

**I**N addition to the more important fastenings such as Locks, Bolts, etc., previously described, many others are made for special purposes, among which are the following :



Fig. 1.

**CUPBOARD TURN** (Fig. 1).—This is a spring bolt or catch operated by a rotating knob. It is made in a great variety of sizes, styles and qualities, and is adapted to a wide range of uses.

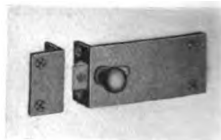

Fig. 2.

**CUPBOARD CATCH** (Fig. 2).—This is intended for the same uses as the preceding, but is operated by a slide knob instead of by one which turns. It is made in both the Rim and Flush varieties, the latter being shown by Fig. 2.

**CUPBOARD BUTTON** (Fig. 3).—This old device is now little used except in work of the cheapest character.



Fig. 3.

**TURN BUTTON** (Fig. 4).—This is a Cupboard Button mounted on a plate. When properly made it is a convenient and substantial device, available for any hinged door or sash.



Fig. 4.

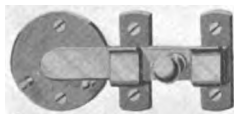

Fig. 5.

**LAVATORY LATCH** (Fig. 5).—This device is intended for use on lavatory doors, but is also available for other purposes.



Fig. 6.

**ELBOW CATCH (Fig. 6).**—This is a convenient fastening for the standing part of the double doors of pantry closets and the like.

**BOOKCASE BOLT (Fig. 7).**

—This is an automatic device, mortised into the soffit of a bookcase or other cabinet, in such position as to engage with the top edge of one door of a pair, and operated by the act of closing the other door which carries the lock, so that both doors are fastened (or released) by a single action.



Fig. 7.



Fig. 8.

**SCREEN DOOR CATCH (Fig. 8).**—This is a Rim Knob Latch, with spindle passing through the door which carries a small knob on its outer end and a knob or bent handle on its inner end. It also has a stop whereby

the latch may be dogged from the inside.

**MORTISE DOOR BOLT (Fig. 9).**

—This is a tubular bolt operated by a rotating knob, and appropriate for bedroom doors.



Fig. 9.



Fig. 10.

**CUPBOARD LATCH (Fig. 10).**—This is a convenient fastening for cupboard doors, consisting of a pivoted latch, actuated by a projecting knob. As shown by the illustration it is furnished

with two forms of strikes, one for application on the edge and the other on the surface of the jamb or door.



Fig. 11.

**CELLAR WINDOW FASTENER (Fig. 11).**— This device is for fastening hinged sashes opening inward. The swinging bar is attached to the window frame, and locks over the upper end of a handle which is attached to the sash for use in opening the latter.

**LEVER CUPBOARD CATCH (Fig. 12).**—

This is a very simple and convenient fastening. It consists of a bar pivoted to a plate and extending inward through the door, its inner end being hooked to engage with a strike, (attached to either side of a shelf), and its outer end terminating in a knob by which the lever may be moved and the door opened.



Fig. 12.

## Section 23.

### Double-acting Hinges.

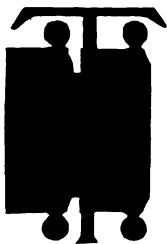

Fig. 1.

THE purpose of these is to permit a door to swing in both directions by combining two hinges in one structure. This implies a much heavier and more costly construction than a single-acting hinge, so that the use of the double-acting hinge is usually limited to the corridor doors of hotels and public buildings, although it is sometimes used on pantry and kitchen doors in private residences.

For these uses, however, it is usually desired that the doors, while free to swing either way, shall be self-closing, and therefore the device commonly used is the double-acting spring hinge (or butt), the character of which is shown by Fig. 1.

In this one or more heavy springs are combined with a double-acting butt in a manner such that, when the door is opened in either direction, the force of the springs tends to close it and to hold it at the neutral or centre position. As no fixed stop can be provided for such a door to close against, it usually swings past the neutral point until the power of the spring is exhausted, and then swings too far again in the other direction, continuing this oscillation until it gradually comes to rest at the neutral point. This repeated oscillation of the door every time it is used is apt to cause an unpleasant noise, is sometimes dangerous to persons passing through it, and, above all, involves unavoidable strain and wear of the double-acting spring butts, so that the latter often need readjustment or repairs.

Notwithstanding all these objections the device has served a useful purpose, has been extensively used and is still the most

available one in certain places, especially for *single* doors which are required to swing both ways. Among the double-acting Spring-hinges which are most favorably known are the "American," "Gem" and "Oxford," made by the Columbian Hardware Co., the "Bommer" and that made by the Chicago Spring Butt Co.

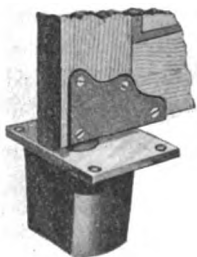

Fig. 2.

For *double* doors, however, a much better arrangement has become available recently, viz.: the Duplex Stop and Blount Checks, which are fully described in Sec. 24, and which, at equal or less cost, accomplish the desired purpose in a better manner, and with greatly reduced liability to accidents and need of repairs.

Another device for the same purpose is the double-acting Floor Hinge, made by Bardsley, Bommer Bros. and others, the general character of which is shown by Fig. 2. The door in this case swings on a pivot instead of a hinge, and this involves a modification of the door and its frame, which must be provided for in the original plans.

An unavoidable, and sometimes very objectionable, defect in *all* double-acting hinges is that they preclude the use of any stop for the door to close against. Hence, the door never closes by "first intention" (to use a surgical phrase), but only after repeated oscillations in each direction, and, still worse, is held very insecurely in the closed position, so that it yields easily to wind pressure and thus is ineffective against drafts. All of these difficulties are overcome by the more modern and better device: the Liquid Door Check, described in Sec. 24.

## Section 24.

---

### Door Springs, Checks and Stops.

**D** **DOOR**



Fig. 1

tion of samples rather than from catalogue.

SPRINGS are made in a great variety of styles and grades, from the simple torsion-rod known to an earlier generation by the name of Torrey and still in use, to elaborate coil springs with heavy mountings and of excellent quality. As they are seldom included in Architects' specifications they will not be described in detail here. If needed they should be selected by the inspection of samples rather than from catalogue.

The door spring has for many years been in universal use in America, but public sentiment was long undecided whether it should be regarded as an unqualified convenience, an unmitigated nuisance or a necessary evil. This state of doubt was ended, some fifteen or more years ago, by the invention and introduction of the Door Check, a device intended to curb the "pernicious activity" of the door spring by compelling it to behave decently and to perform its useful function without "getting on the nerves" of everyone within hearing. Unfortunately, however, escape from one difficulty led into the jaws of another. All the earlier door checks, of which the Norton was the best and most widely known, were of the pneumatic type, that is they depended on the use of *air* as a cushion to resist the force of the spring. In effect each was a reversed air-pump. Now the only effective and simple packing which has been found for the piston

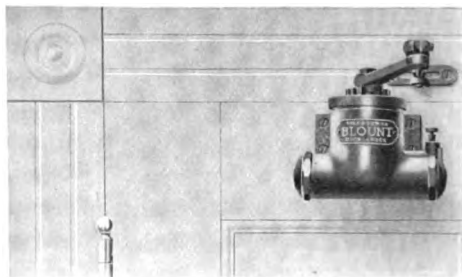

Fig. 2. Right-hand Door from Inside. Use Right-hand Check.

of an air-pump is a cup made of leather which has previously been thoroughly soaked in oil. So long as this remains soft and pliable it makes an excellent packing, but when it becomes dry and hard it becomes useless as such, and experience has long since shown that, as used in pneumatic door checks, such packings deteriorate rapidly, and ultimately give out entirely. This is due not only to the drying out and oxidizing of the oil, but also to the glazing and wear of the leather from its constant rubbing against the cylinder. The change which thus occurs is continuous from the time the check is put into use, necessitates frequent readjustment of the regulating valve, and ends in permitting the door to slam unchecked, thus reverting to the "original sin" which the device was desired to eradicate.

The combination of a Door Spring and Check, however, produced a result too satisfactory and too useful to be lost, and a recent invention averts this danger by furnishing a device which meets all the requirements of the case. This is the Yale-Blount Combined Door Spring and Check, first introduced about 1895, the latest model of which is shown by Figs. 1 to 3. This check is of the hydraulic type, the resistance to the piston being

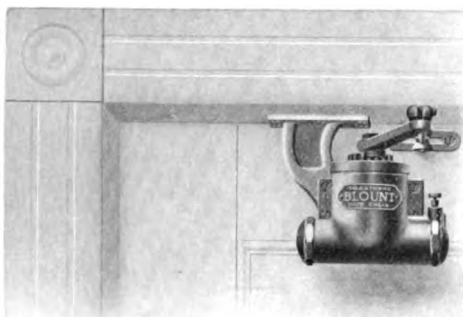

Fig. 3. Left-hand Door from Outside. Use Right-hand Check.

a non-freezing liquid instead of air. By this substitution of a suitable for an unsuitable checking medium all difficulties were overcome, and an absolutely satisfactory and permanent device obtained.

Full information concerning the Yale-Blount Door Check, as the device is usually termed (although it includes a spring), is given in Part VI, but it may here briefly be explained that the check consists of a metallic piston, without packing, moving in a tightly sealed metallic cylinder containing a lubricating and non-freezing liquid, the movement of the door depending on the escape of this liquid, around the piston, from one end of the cylinder to the other, this being controlled by a valve which can readily be adjusted to produce any desired action of the door. Once properly applied and adjusted it will continue to function permanently, without appreciable change or wear. It closes the door silently, with a smooth, steady motion and without the rebound so noticeable in an air check.

Another good check of the liquid type is the Corbin, which embodies the same general principle as the Yale-Blount, but does not include all of the improved details of the latter.



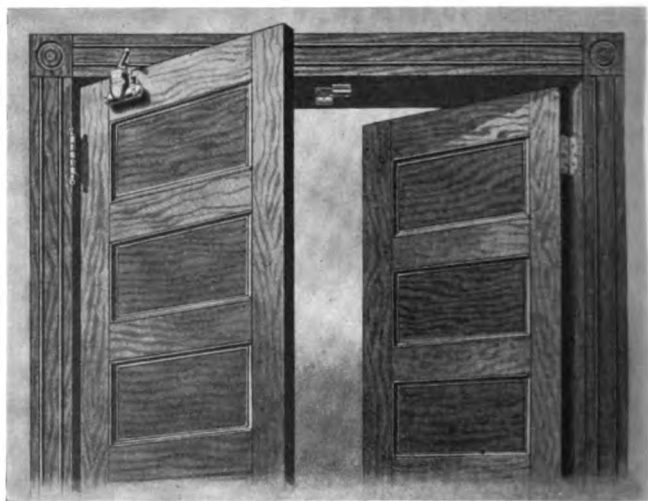

Fig. 4. The Yale-Blount Check and Duplex Stop.

The Yale-Blount Door Check, combined with the Duplex Stop (see Fig. 4) affords the best method of mounting double doors which are required to swing both ways, and is an ideal substitute for the objectionable double-acting spring hinge. It eliminates the danger and unpleasant "flip-flap" of the latter, and, by dividing the tide of travel into two streams, each always moving in the same direction, greatly facilitates movement in crowded passages.

The general employment of door checks, wherever a door spring is needed or desirable, has been greatly retarded heretofore by the faults and failures of the *pneumatic* check. This difficulty is now overcome by the Yale-Blount *liquid* Check, and as the reliability of this becomes better known the use of door checks, already very extensive, is sure to increase largely and permanently. Already it is becoming usual to apply them to all corridor doors of large office buildings, and even to room doors in hotels, while

they are everywhere in evidence on entrance doors of all kinds, and on pantry, water-closet and other doors of frequent use which it is desired shall not stand open. For this reason it is increasingly customary to include door checks in the original equipment of a new building, rather than to leave them for subsequent application. This implies their inclusion in the hardware specification or contract, in which case it is important that checks of the proper kind, size and finish should be specified. Information on these points is given in Part VI.

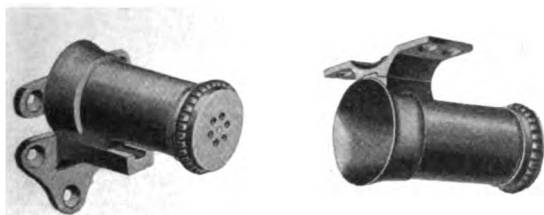

Fig. 5. The Pneumatic, or Air, Check.

For some minor uses the air Check is still in use, and one of the latter, made by Sargent & Co., is shown by Fig. 5. This is a buffer, or air cushion, against which the door impinges when closed by a spring, and which tends to cause the door to close without slamming. It possesses the defects common to *all* air checks, how-

ever, and, at the small difference in cost which exists, the *liquid* check is always preferable and, in the end, cheaper. —

For some uses, notably for screen doors and the doors of hotel water-closets, (usually to hold the latter *open*), a simple Spring-hinge is used, an example of which is shown by Fig. 6.

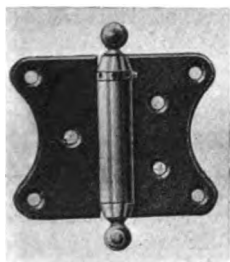

Fig. 6.

A Door Stop is a device for limiting

the backward swing of a door, and it may also have the additional function of holding the door in an open position, in which case it is designated as a Door Holder. The ordinary door stop is



Fig. 7.



Fig. 9.

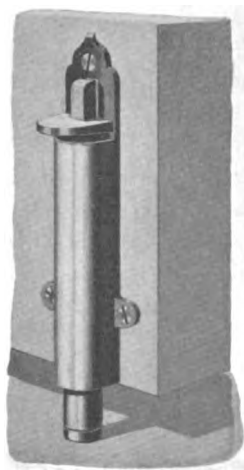

Fig. 10.

simply a Knob, usually of wood and with a rubber tip or ring, for insertion in the wainscot or floor, but better grades, made of metal and of various forms, as shown by Figs. 7 and 8, are available. With these may be combined a hook for fastening the door in the open position, as shown by Fig. 9.



Fig. 8.

Where facility is desired for holding the door in any position, or for quickly fastening it open and soon releasing it again, as in case of a pantry door operated by a Yale-Blount Check, a Door Holder, as shown by Fig. 10, should be availed of, the action of which is conveniently controlled by the foot. In this connection it may be mentioned that serving-windows, between kitchen and pantry, will be found very convenient and effective, if closed by a *hinged* sash, controlled by a Blount Check of small size, which will automatically, but quietly, close the sash after each use, thus preventing the passage of kitchen odors and noises.

## Section 25.

### Hinge, Corner and Kick Plates.



Fig. 1.

**M**EDIÆVAL hardware was the product of the blacksmith and the whitesmith, the former working with forge and hammer, and the latter with chisel and file, the material being wrought iron. The butt-hinge was unknown, and the strap or surface hinge in universal use, and as this was wholly in sight it became naturally the subject of decoration, chiefly in outline, but occasionally also by surface ornament. Hence followed the practice of making the hinges, especially of large entrance doors, a prominent feature of ornament, and of supplementing them with similar plates of metal at the corners of the door, which served the double purpose of strengthening the door and of adding to its decoration.

With the adoption of the butt-hinge (that is, one applied to the edge or "butt" of the door) for general use the opportunity for utilizing the hinge to decorate the surface of the door disappeared, but with the modern revival of decorative art the desirability was quickly perceived of restoring the use of constructive metal-work as a feature of surface decoration for important doors. This is accomplished by combining with the modern butt (which carries the door) a surface *plate* which simulates the strap-hinge.

Obviously the width of the butt of a hinge-plate should correspond with the height of the butt-hinge with which it is to be

used, and both should be of the same metal or finish. Its other dimensions are governed by the size of the door and by taste, as is true also in the case of corner plates. The variety of designs and sizes now available is such that special patterns are rarely necessary. In Part VII, Section 2, will be found illustrations of a few hinge and corner plates which will indicate the possibilities their use affords.

A more modern device is the "kick plate," applied to the bottom rails of much used doors, especially when hung on double-acting hinges, as in public buildings, to receive the wear incident to the use of the foot in opening such doors. These are frequently made of sheet bronze or brass, but are much handsomer when made of cast metal and ornamented to harmonize with the other metal work of the door. As indicated by the illustration below, and others in Part VII, Section 2, the latter treatment admits of very effective and even elaborate development, extending occasionally over nearly the entire surface of the door.

In ordering door plates of all kinds the architect should consult the manufacturer and avail of existing patterns so far as possible, unless prepared to incur the expense which special designs and patterns entail.



Fig. 2

## Section 26.

---

### Trim for Special Conditions.

**N** ADDITION to the standard articles described in the preceding sections of this part a great number of devices of special construction and of different sizes are made, a selection from which will usually meet almost any conditions likely to arise.

To utilize these, however, it is important that a knowledge of them should be obtained before the details of woodwork are made, in order that, if possible, the latter may be conformed to the conditions for which the hardware is intended, thus avoiding the necessity for special hardware and the increased cost which this would entail.

To this end the Architect or draughtsman, when making detailed drawings of woodwork which obviously involves the use of hardware of special character, should inform himself *at the time* concerning the hardware which may be available, and if possible should harmonize the details of the woodwork thereto.

This information can best be obtained, either through a dealer or by direct correspondence, from one of the larger manufacturers of Builders' Hardware, each of whom has a great variety of special devices additional to those shown in their catalogues, and who, if advised of the problem to be solved, can usually suggest methods which will give the desired results by utilizing existing devices without resorting to the expensive process of designing and making special hardware.

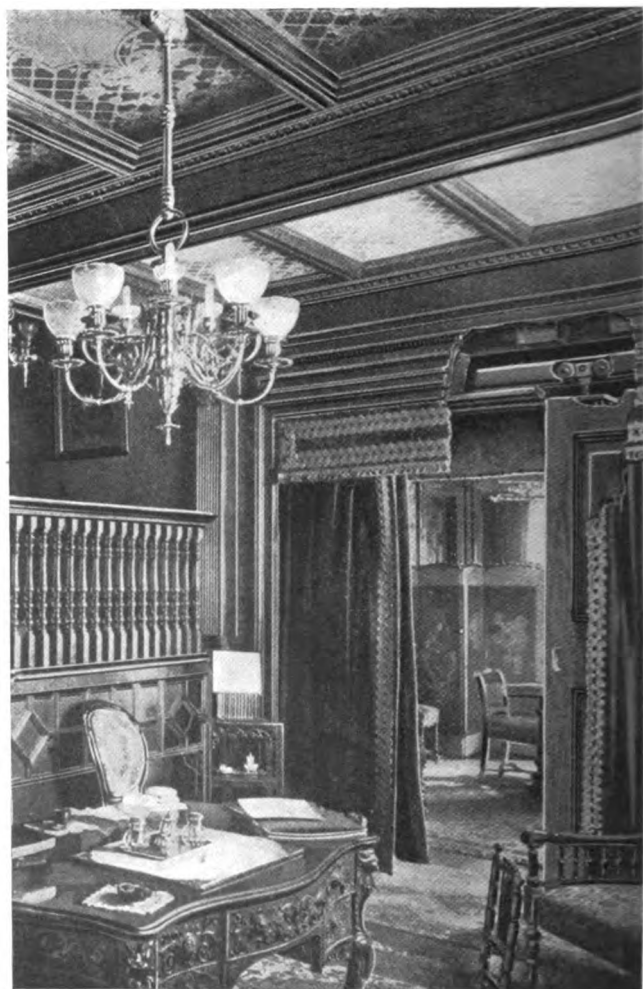

**Fig. 1.** Woodwork broken away to show Sliding Door Hanger in position.

## Section 27.

### Sliding Door Hangers.

**F**ORMERLY sliding doors were carried on shieves or rollers, located at bottom of door and traveling on a metal track inserted in the floor, but this system has been almost universally displaced by the more modern one in which the sliding door is suspended by hangers, at the top, which carry wheels running on an overhead track contained in a recess formed for the purpose above the soffit of the doorway: see Figs. 1 to 4.

The use of the overhead hanger implies a special construction of the door jamb, to provide space for the overhead track and a proper support for its brackets. Therefore it becomes necessary to determine *in advance* the type of hanger to be used, and to conform the framing and other details of the door-way thereto. For these and other reasons sliding door hangers are usually

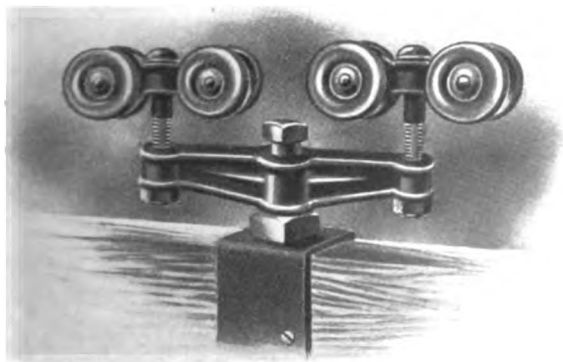



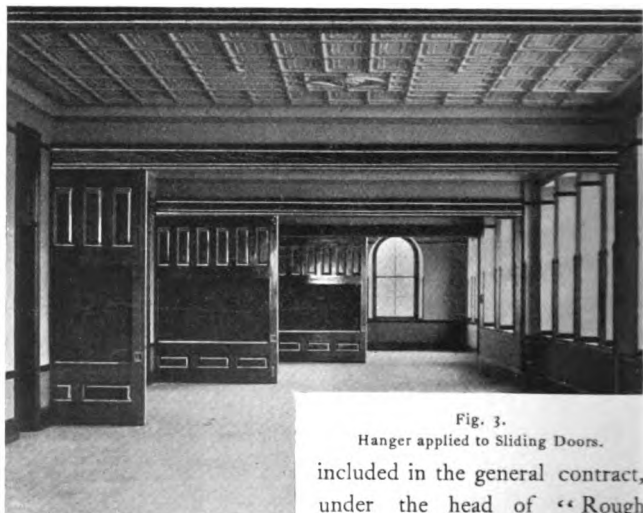

Fig. 3.

Hanger applied to Sliding Doors.

included in the general contract,  
under the head of "Rough

Hardware," and do not properly belong under the head of "Finishing Hardware."

In the case of any hanger, the most important features to be considered are the strength and stiffness of the track; the provision for adjusting it when necessary; the provisions for reducing friction and noise; and, finally, the strength and quality of the several parts, and the facility with which they can be fitted in place and adjusted when in use.

In all first class hangers the track is made of steel, but in some cases this carries a hard wood surface on which the rollers run, while in others they rest directly on the metal. Noiselessness is sought by the use of a wooden track surface (as mentioned above), by means of fibre wheels, and by the use of ball bearings, these latter serving also to diminish friction. The practice of the different makers varies in these respects, and most of them make hangers of several grades.

Among the sliding door hangers which are most favorably known may be mentioned the McCabe, the LeRoy and the Coburn.

The various manufacturers have intelligently studied the modern conditions and requirements of sliding and folding doors of every kind, and detailed information will be found in their catalogues concerning all of the various types and grades of hangers. The best results will usually be obtained by consulting these, and, after selecting the type of hanger preferred, by stipulating in the contract that the maker, or his agent, shall be responsible for its satisfactory operation, subject, of course, to its proper installation by the contractor or builder.

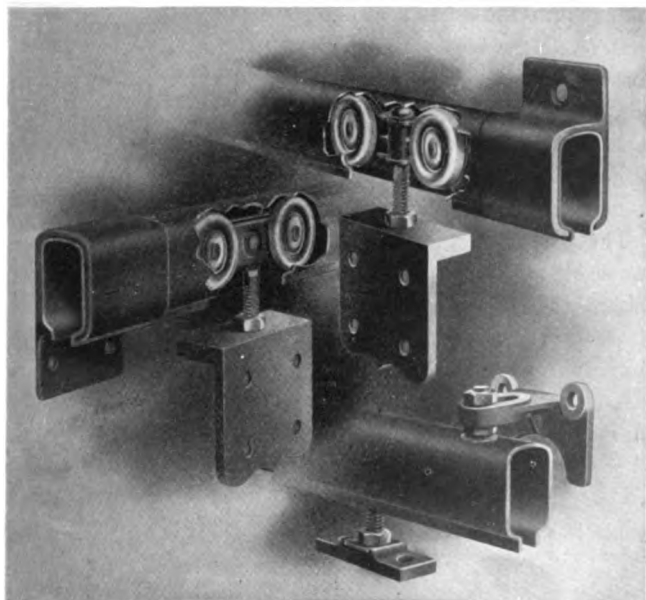

**Fig. 4. Steel Hangers and Tracks.**

## Section 28.

---

### Pivoted Window Trim.

**T**HE problem of mounting large, single light sashes so that they may be opened by rotating on a vertical axis, and yet when closed be weather tight, is one involving numerous and rather serious difficulties.

The best device thus far available for this purpose is Giesey's Elevating Window Pivot, which pivots the sash vertically and, by means of a lever (which lies horizontally against the bottom rail of sash when at rest), can be operated to lift the entire sash until its bottom is clear of the lower stop-bead and the sash is thus free to swing over the latter. A false head, or follower, rests on the upper rail of the sash, which, when the latter rises, enters into a pocket or recess in the head of the window frame, the top rail of the sash when raised thus clearing the under side of the head of window frame.

The device is of simple but substantial construction, and thoroughly accomplishes its purpose. It is made in all sizes and finishes, and holds the window when open at any desired angle. No other hardware is necessary for a window where the Giesey Pivot is used.

As a special construction of the window frame is necessary for this device, full information concerning it should be obtained *in advance* and be embodied in drawings and specifications. The necessary information can be obtained from the manufacturers, Steiner & Voegtly, Pittsburgh, Pa.

## Section 29.

### Padlocks.



Fig. 1.  
Cast Bronze, No. 851.

**P**ADLOCKS are not included in the term "Builders' Hardware" and therefore will not be described herein. Occasionally they are required in connection with Architects' work, and in such cases should be selected carefully by sample.

Padlocks are made in a vast variety of sizes, styles and qualities, retailing at prices ranging from \$5.00 each down to ten cents or less. For use where exposed to moisture or the weather they should be of bronze; where exposed to violence they should be heavy, and preferably should have steel shackles; where used in series a type should be selected which has numerous tumblers and key-changes; where wanted under control of a master-key a type should be chosen which admits of master-keying without undue impairment of security. A selection should always be based on an inspection of actual samples, not on catalogue representations.

The illustrations herewith represent two of the best known high grade Padlocks (one of which can be master-keyed when desired), selected from the extensive line made by the Yale & Towne Manufacturing Company.



Fig. 2.  
Wrought Steel, No. 8454.

## Section 30.

### Cabinet Locks.



Yale Paracentric  
Cabinet Lock.

**L**OCKS FOR furniture and cabinet work, designated generically as "Cabinet Locks," are quite distinct from Builders' Locks, and constitute a separate industry, but enter occasionally into the work of the Architect. They are made chiefly of wrought metal, and in a vast variety of kinds, sizes and grades, and owing to this diversity much care should be exercised in their selection where good quality is sought.

The leading kinds are Drawer (or "Till") locks, Wardrobe locks, Chest and Box locks, and Desk locks, but there are many others for special uses, and the catalogue of a manufacturer should be consulted for full information. A complete line is made by the Yale & Towne Manufacturing Company, and selections from this, covering the locks most commonly required in connection with the work of Architects, are described in Part IV.

The Yale Lock (pin-tumbler type) is to be preferred for the best work, and wherever high security is desired, while for other uses other types are available, both with flat and with round keys. Many of them admit of being *master-keyed*, for use on lockers in club-rooms, armories, etc. For Desk Lids the Pasquil lock is the best type.

An extensive line of Cabinet Hardware is described in Part VIII, and some such Hardware is included in many of the lines of ornamentations illustrated in Part III, Section 3, under the various Schools of Ornament.

## Section 31.

### Trunk Locks.



Yale Paracentric  
Trunk Lock.

LOCKS for trunks, suit cases and bags constitute a wholly distinct class, and one in which the architect has no interest, except as an individual user, for which reason they will not be described in this volume. Their manufacture is usually combined with that of cabinet locks, with which they have much in common, and a complete line is made by the Yale & Towne Manufacturing Company in its cabinet and

trunk lock department.

These locks are made in a great variety of kinds, sizes and grades, from an expensive lock of the Yale, pin-tumbler, type, to the simplest and cheapest kinds. Naturally the latter are chiefly used by trunk-makers, and purchasers who desire locks of the finer grades must expect to pay accordingly and must exercise care in selection.

The illustration above shows the Yale & Towne No. TB600 Trunk Lock. This is of the "Yale" type with Paracentric keys, is of heavy cast bronze and of higher grade than any of the trunk locks commonly used. Where wanted it can be obtained from trunk makers, and should be specified by the above number.

## Section 32.

### Asylum Locks.

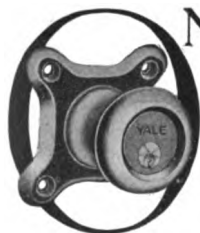

**N** THE doors of Hospitals for the Insane, of Reform Schools, and other Public Institutions, locks of special character should be used, designed and adapted to meet the peculiar conditions of the service, especially where their function is rather to lock individuals *in* than to keep intruders *out*. Such locks, particularly for Insane Asylums, are exceptionally exposed to attempts at tampering, and accordingly should be especially constructed to meet these conditions.

Convenience in service commonly demands the use of spring latch-bolts, and this in turn involves special methods of construction to protect such bolts from attack, through the crack of the door or otherwise. This is accomplished by the use of guarded fronts, box strikes and other precautions. An extensive line of locks for these uses, including provision for control by master-keys, is made by the Yale & Towne Manufacturing Company, full particulars concerning which can be obtained on application, and such information should always be sought *in advance* when preparing plans and specifications.

## Section 33.

---

### Prison Locks.



THE locks required for the cell and corridor doors of prisons constitute a wholly distinct class, which, however, only interests those architects who concern themselves with prison construction and, therefore, will not be described in detail herein.

The Yale & Towne Manufacturing Company has for twenty-five years made a specialty of locks for Prison use, the conditions of which are entirely special and call for unusual care in designing and unusual thoroughness of construction. The line of prison locks includes a series of the Yale type, of special and very heavy construction, and also locks of the lever-tumbler type, both with solid and barrel keys, thus affording opportunity for a wide range of selection, whether governed by individual preference or surrounding conditions.

A catalogue of Prison Locks will be furnished on request. Correspondence is solicited concerning such locks and in reply full information, together with drawings, samples, and other useful data will be submitted if desired. The most approved forms of Prison Locks require to be built into the walls during construction, for which reason their selection needs to be made at an early stage.



## Section 34.

### Bank and Safe Locks.



**LOCKS** FOR the doors of Burglar and Fire-proof safes and vaults constitute a group not only distinct from all others but also pre-eminently the highest in technical excellence of all included within the art of the modern lock-maker. The fact that the modern architect is now often called on, in connection with plans for bank buildings, to include vault work and its fastenings in his specifications, justifies a somewhat detailed reference to Bank locks in this volume.

The locks embraced in this group comprise Time, or Chronometer, locks; Dial, or Combination, locks; Safe Deposit locks; and "Sub-treasury" locks. The device known as a "Bolt-motor," or "Automatic," is an allied product. The essential characteristics of each of these will be briefly described; for fuller particulars reference is made to a special catalogue issued by the Yale & Towne Manufacturing Co., whose business originally consisted exclusively in the designing and making of Bank locks, of which product it is still the oldest manufacturer in this country, and the largest in the world, its experience extending over more than half a century, and its facilities embracing a most extensive practical knowledge of the art, the most modern and complete equipment, and the skill of numerous experts and specialists. This experience and knowledge is at the disposition of architects and engineers, and should be availed of in the selection of locks and the preparation of specifications.

**TIME-LOCKS (Fig. 1).**—The Time-lock is a locking mechanism actuated by clock work, and used in connection with the heavy bolt work of a safe door to prevent the unlocking of the latter except during predetermined hours. The Yale time-lock has been in use upward of twenty-five years, and is now recognized

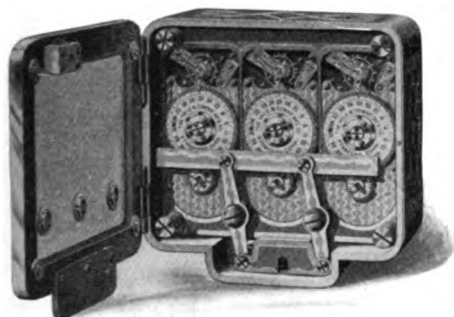

Fig. 1. Yale Time-lock with 3 Chronometer Movements.

as an essential part of the equipment of all first class burglar-proof vaults and safes. In its standard form it has three chronometer movements, of the finest construction, each competent alone to actuate the lock, thus

affording a guaranty, which experience has shown to be absolutely reliable, for the proper functioning of the lock.

**DIAL OR COMBINATION LOCKS (Figs. 2 and 3).**—In America the Combination, or, as it is commonly called, the Dial lock, has completely superseded the key lock for use on safe and vault doors. Essentially the Dial lock consists of a bolting mechanism (usually employed to check the heavy bolt work of a safe door) guarded by a set of changeable tumblers or wheels, and actuated by a spindle passing through the door provided on the outer end with a graduated dial, by rotating which in a certain manner the tumblers can be set and the lock be operated. Dial locks are made of two grades or varieties, designed respectively for burglar-proof and for fire-proof safes, the former being heavy, elaborate and intended to resist violence, while the latter are

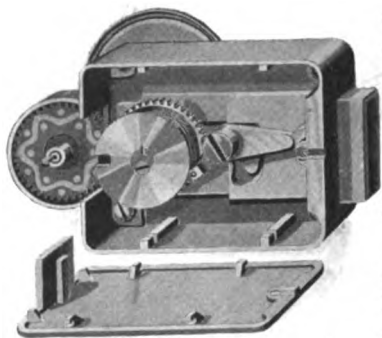

Fig. 2. Yale Dial Lock for *Burglar-proof Safes*. some ten years been extensively used on burglar-proof safes. The bolt motor is a mechanism attached to the inside of a safe door, containing heavy springs which are set or compressed while the door is open, and which, when released by the action of the time-lock always associated with the bolt motor, are capable of automatically retracting the heavy bolt work of the door. This construction obviates the necessity of any spindle through the door, and leaves the surface of the latter absolutely unbroken, and without communication between the interior and exterior.

**SAFE DEPOSIT LOCKS.**—The great development of safe deposit vaults in America has brought into existence a new type of lock intended expressly for the individual safes or boxes rented by the safe deposit company to its customers. Such locks are nearly always provided with a guard-key, in charge of the custodian and common to all of the

smaller, simpler and cheaper, being intended only for fire-proof doors not designed to resist great violence. All of them are, or should be, *absolutely unpickable*.

**BOLT MOTORS.**—In connection with the time lock an automatic bolt operating device has for



Fig. 2. Yale Dial Lock for *Fire-proof Safes*.

locks in a series, each lock having also an individual key, which fits only its own lock and differs from every other key in the series, the latter being known as the change-key. Before a change key can be inserted or used in its lock the guard mechanism must be unlocked by the guard-key in charge of the custodian. The presence of the latter is thus an essential preliminary to the unlocking of a lock, even by a box renter or other authorized person in possession of the proper change-key.

A variety of styles and sizes of Safe Deposit locks is made to meet varying conditions, the highest type being the Yale lock with paracentric key. Great additional security is obtained in some cases by keys of special proprietary forms. For Safe Deposit Boxes of large size a Dial lock is sometimes used.

**SUB-TREASURY LOCKS.**—This term is applied to locks intended for use on the small inside safety chests, or “Sub-treasuries,” often placed within a fire-proof safe. Such locks are of various types and sizes, and are suitable for use on metal doors of *all kinds*.

## Section 35.

### Post Office Lock Boxes.



Yale P. O. Lock Box.

THE Americans were the first to appreciate the convenience of equipping a post office with individual mail boxes, and the "call box" has long been a feature in post offices in the United States, and is still largely in evidence in country towns and villages. The invention of the Yale lock, however, with its great security and vast capacity for key-changes, led to the introduction, about 1870, of the metallic lock box, and ultimately to its general adoption in all of the larger post offices and in many of the smaller ones.

The Yale & Towne Manufacturing Company has, for some twenty-five years, been the contractor to the United States government for furnishing the Yale Lock Boxes used in all government post offices, and these boxes have also been furnished generally to postmasters throughout the United States and to many foreign governments. They are now in daily use in more than ten thousand post offices.

## Part III.

---

Art Metal Work and Ornament.

## Part III.

---

### Art Metal Work and Ornament.

Section.	Page.
1. The Relation Between Hardware and Art, . . . . .	227
2. Architect and Client, . . . . .	230
3. The Schools of Ornament, . . . . .	235
Introduction, . . . . .	235
Index by Schools, . . . . .	236
Index Alphabetically Arranged, . . . . .	244
Preface by W. W. Kent, . . . . .	285
Articles by W. W. Kent and Examples of Yale & Towne Designs, . . . . .	288
4. Emblematic Hardware, . . . . .	582
5. Proprietary Hardware, . . . . .	586
6. French Hardware, . . . . .	590
7. Metals and Finishes, . . . . .	595

## Section I.

---

### The Relation between Hardware and Art.

IT is unfortunate that America has adopted the unsatisfactory term "Hardware" to designate the finer as well as the rougher interior metal work, both of utility and of decoration, used in buildings, although some consolation may be derived from the fact that the word is less inappropriate than the still more objectionable English term "Ironmongery;" but it is too firmly established to be challenged and therefore must be allowed to pass.

It is well to remember, however, that in its broad sense it covers equally the metal work of *construction*, such as nails, screws, and other permanent fastenings; the metal work of *convenience*, such as locks, hinges, bolts, etc.; and the metal work of *ornament*, such as escutcheon plates, knobs, hinge-straps, etc.

The necessity for expressing this differentiation by words has led recently to the practice, which it is to be hoped may be generally adopted, of using the terms "Rough Hardware" and "Finishing Hardware;" the former to designate constructive and rough material, such as sash weights and pulleys, sliding door hangers, etc., and the latter to designate all material intended for protection, convenience and ornament, especially that which is visible when in place.

The term "Hardware of Ornament" has also been suggested for the latter group, but the term "Finishing Hardware" is better, because more terse and because better covering locks, hinges, bolts, etc., which are included in this group and yet usually are not treated ornamentally.



The story of the *naissance* of artistic hardware in America has been told in Part I. Its sponsors during its infancy were certain American architects, all of high standing in their profession, who greatly promoted its growth during the early years of doubt and inexperience by suggestion and advice, and still more by specifying the new product in their work, and its present great development and vogue are due above all to the sympathetic and cordial appreciation of the profession in every section of the country, the practice of which tends steadily to give increased prominence to Hardware as an important detail of interior decoration, and to devote increasing care to its intelligent adaptation to its environment.

From the new conditions thus created has arisen a new and keen interest in the study of the historical Schools of Ornament, first by the makers of artistic hardware, as a necessary qualification for their work, next by architects when criticising the new product or selecting it for use, and finally by discriminating owners when considering questions relating to the interior decoration of residences or other proposed buildings.

Recognizing the wide-spread interest in this subject which thus prevails, and aware of the fact that no publication exists in which it is briefly and simply discussed, the author has arranged with Mr. W. W. Kent, Architect, of New York, long a student of the subject and a recognized authority on it, to furnish the series of papers on the Schools of Ornament which is included in this Part of the present volume.

By all to whom the subject appeals Mr. Kent's papers will be found to be full of interest and information, and also to demonstrate clearly the relation which has recently but definitely been established between decorative Hardware and Art.

Because of the closeness of this relation it has been thought best to combine with each paper a classified list of available Hardware in the School described, thus providing a working catalogue containing all data necessary or useful in the selection of Ornamental Hardware of any School and for any purpose.

## Section 2.

---

### Architect and Client.

**B**EFORE entering upon the subject of the Schools of Ornament, and the details of the Hardware of Ornament, a word may be permitted as to the relations of the Architect to his Client in regard to these matters.

The client seeks the architect in order to have the benefit of his professional experience and skill, not only as a constructor, but also, and often chiefly, as an artist; and the architect should welcome this recognition of the artistic side of his work by encouraging the tendency to rely on him as to all matters of ornamentation. In buildings of public and commercial character this practice prevails, and here the architect takes interest and pleasure in carrying out his own ideal, and in harmonizing every detail of ornament, but in the great field of residence work the necessity usually arises for consulting the tastes, and often the whims, of the client, especially in the details of interior decoration. Yielding to these conditions, architects in the past have too often, without protest or effort, allowed a client to take into his own hands much of the final work of interior decoration, with more or less disastrous results. Even if, by chance, the work so done harmonizes in *motif* and execution with the general scheme, the client takes credit for the good result, while if the contrary occurs, as is far more apt to be the case, the resulting discredit is usually transferred to the architect.

Heretofore hardware has been too much regarded as an indifferent detail which could safely be left to the general contractor to select and supply. Even when specified, it has usually been in such a loose and vague manner as to help matters

but little, owing doubtless to the complex and technical character of the information required, and the difficulty entailed on a busy architect in obtaining and formulating it for use. This difficulty, it is hoped, will be diminished, if not removed, by the aids supplied by this volume, but it will still remain a fact that the most, if not the *only*, satisfactory plan consists in *excluding the "finishing hardware" from the general specifications and reserving it for selection by the architect or owner.* Who would venture to propose, for example, that the selection of mantels, of fire-place fittings, of lighting fixtures, or of wall-papers for a private residence, should be left to the taste and *liberality* of the general contractor? Each one of these enters directly into the interior decoration of the house, and is a matter of direct concern to its owner and occupant, for which reasons they are almost invariably reserved for his personal selection, either alone or in consultation with the architect. In the foregoing question we have purposely italicized the word "*liberality*" to emphasize the fact that whenever *any* material, other than that which is constructive, or which is covered by a complete and rigid specification, is left to the selection of the contractor the question of liberality on his part is introduced, *ipso facto*, because the amount to be expended for it is put under his control, and self-interest is thus enlisted to make this amount as small as possible. As well might carpets and furniture be embraced in the general specification and contract for a residence as these still more important, because more permanent, elements of interior decoration. The one safe rule for *all* of them, including so much, at least, of the hardware as is decorative in purpose, is to reserve them absolutely for selection by the architect or owner.

Of all of the subordinate elements of interior decoration there is none which offers a larger opportunity for effective results and for the exercise of personal taste than the metal work for doors

and windows, and this is now available to the architect and his client in such variety of character, grades and prices as to satisfy all tastes and to suit all purses. In classic architecture metal work played but a small part, but during the middle ages, with the advance in the art of metal working, this element of decoration attained great prominence and development. In America social and commercial conditions were unfavorable to the development of architecture and the allied arts, except to a slight extent during the Colonial period, until comparatively recent years. The lessons of the Centennial Exhibition of 1876, however, broke the indifference and barrenness of American designers, and gave that initial impulse to architecture and decorative art in this country which has since produced the splendid results with which we are now so familiar and which were so markedly in evidence at the Columbian Exposition of 1893.

In a new country like this the growth of taste in household art, and the appreciation of the right use of art work, come only with the growth of leisure and of wealth, but as culture, art and travel extend, the general perception of these things quickly takes root and grows apace, so that already the American connoisseur demands not only the possession but the daily use of articles of decoration, of almost every kind, which only a few years ago would have been cherished in some museum of the fine arts; and this is equally true of his home, his place of business, and his greater buildings devoted to public service and convenience.

However much artistic metal work may appeal to the trained intelligence of the architect as an effective element in his general scheme of decoration, it appeals still more, in the case of private residences, to the owner and, above all, to the lady of the house, as affording an opportunity where an educated taste and the judicious expenditure of money, yield a more effective result and a more lasting pleasure than can be procured at equal cost in any

other way. The metal work used on a door, whether elaborate and costly, or simple but elegant, as the case may be, is like the jewel on a handsome costume, the latter serving merely as a background for the effective setting of the smaller but more costly ornament which it presents. The knobs, plates and hinges of a door *compel* attention by the prominence of their form, position and environment. If inappropriate and unpleasing they obtrude themselves upon all who enter or use the apartment; if handsome and in harmony with their surroundings, they arrest attention even more than larger and more pretentious articles of adornment which may surround them.

In continental Europe, especially France, these facts are always recognized, and hardware usually aims to be decorative. Personal observation, however, justifies the unqualified statement that to-day American hardware is superior in general qualities to that made in any other country, both in mechanical and in artistic design and execution, the only reservation being as to certain special and very expensive door and window fittings in which modern French work is perhaps still somewhat in advance, although even this reservation will not long need to be made.

The American architect and his client thus have an unparalleled range of choice of ornament from the wealth of designs which the American manufacturer has provided, with corresponding room for the exercise of tasteful discrimination, and have also the privilege of availing of what is mechanically the best and most convenient product of its kind in the world.

The average client does not know these facts, but the well-informed architect does, and the latter should see to it that they are brought to the attention of the former at the proper time and effectively, precisely as in the case of other details relating to a proposed building. Guided by experience, or by the information afforded by this volume, the architect should determine, *in*

*advance*, the approximate cost of such hardware as his judgment indicates to be appropriate, should include this in his estimate of total cost, and, above all, should exclude the hardware from the general contract, reserving it for personal selection at the proper time, untrammelled by any previous contract or commitment.\* If the client is then disposed to increase the original appropriation, the architect will have the satisfaction of obtaining proportionately richer effects; but in any event he will be assured of having a fund adequate for the purchase of hardware which, however simple, will be appropriate and not incongruous with the other details of his own work. The condition most to be desired (*and to be sought*), at least in the case of important residence work, is that the owner shall join the architect in the inspection and selection of all important hardware, both of convenience and of ornament, and thus be led to subordinate the question of cost to that of obtaining the best and most appropriate material. The most successful combination for this purpose usually includes also "the lady of the house."

While the argument thus advanced concerning the relations of Architect and Client has had reference chiefly to questions of art and decoration, it applies with almost equal force to questions of utility. American hardware has become a very complex and comprehensive product, in which a vast amount of the traditional "Yankee ingenuity" has been embodied, and an intelligent understanding of its scope, varieties and uses is beyond the knowledge of the normal client, but of course is, or should be, included in that of his architect. The responsibility rests on the latter, therefore, of acting for or guiding the former in the selection of such hardware as, within the limit of proper cost, will afford the highest protection and convenience, as well as contribute most effectively to the scheme of decoration.

\* For Forms of Specifications and Contracts see Part IX, page 994.

## Section 3.

---

### The Schools of Ornament.\*



HIS section consists chiefly of original papers by Mr. W. W. Kent, architect, each treating of a separate "School," the whole forming a series of unique interest and value. These are preceded by indexes, and followed by some minor papers on related subjects.

In view of the close connection, in the scheme and purpose of this book, between the theory and practice of the art of ornament, it has been thought best to unite with each of Mr. Kent's papers illustrations of available hardware in the School discussed, and to accompany these with descriptive matter and indications of relative cost, thus completing the subject and making this section available to the architect for practical purposes.

\* In most cases the names used arbitrarily to designate the Yale & Towne Ornamentations and Designs are those of cities in which the particular School flourished.



# Index

## Arranged Alphabetically by Schools.

### YALE & TOWNE DESIGNS.

For arrangement alphabetically by *Designs* see page 244.

Design.	Builders' Hdw. Page	Cabinet Hdw. Page	Design.	Builders' Hdw. Page	Cabinet Hdw. Page
---------	---------------------------	-------------------------	---------	---------------------------	-------------------------

### Byzantine.

For descriptive article see pages 355 to 361.

Fronsac, . . . . .	361		Torcello, . . . . .	757	
Libourne, . . . . .	753				

### Celtic.

For descriptive article see pages 375 to 379.

### Chinese.

For descriptive article see pages 303 to 305.

### Colonial.

For descriptive article see pages 539 to 555.

Adams, . . . . .	548		Brunswick, . . . . .	549	
Amherst, . . . . .	548		Burlington, . . . . .	549	
Andover, . . . . .	873		Cambridge, . . . . .	926	
Annapolis, . . . . .	964		Chester, . . . . .	549	966
Arcadian, . . . . .	548		Cohasset, . . . . .	953	
Arlington, . . . . .	548		Colonna, . . . . .	550	966
Aubin, . . . . .	964		Concord, . . . . .	967	
Beverly, . . . . .	965		Dedham, . . . . .	550	926
Bothnian, . . . . .	549		Deerfield, . . . . .	550	
Bourg, . . . . .	549		Derby, . . . . .	967	
Boylston, . . . . .	952		Dorchester, . . . . .	550	
Bristol, . . . . .	549		Dorian, . . . . .	551	
Brockton, . . . . .	966		Dover, . . . . .	953	

Design.	Builders' Hdw.	Cabinet Hdw.	Design.	Builders' Hdw.	Cabinet Hdw.
<b>Colonial—Continued.</b>					
Exeter, . . . . .		926	Piedmont, . . . . .	553	972A
Fairfax, . . . . .	551	967	Plymouth, . . . . .	554	972B
Germantown, . . . . .		954	Portsmouth, . . . . .		928
Guilford, . . . . .	551	. . .	Putnam, . . . . .		928
Hadley, . . . . .	551	. . .	Revere, . . . . .		928
Hartford, . . . . .		927	Roanoke, . . . . .	554	972B
Hellenian, . . . . .	551	969	Salem, . . . . .	554	972B
Hingham, . . . . .	552	969	Saybrook, . . . . .		955
Ionian, . . . . .	552	969	Sentis, . . . . .	554	. . .
Ipswitch, . . . . .	552	. . .	Sparta, . . . . .	554	972B
Ituno, . . . . .	552	969	Stonington, . . . . .	555	. . .
Jamestown, . . . . .	552	927	Strabo, . . . . .		955
Jennico, . . . . .	552	970	Toulon, . . . . .		972C
Lancaster, . . . . .	887	. . .	Traves, . . . . .		972C
Lexington, . . . . .		971	Trento, . . . . .		873
Louisburg, . . . . .		954	Trenton, . . . . .		955
Lowell, . . . . .		971	Vancluse, . . . . .		855
Lynn, . . . . .	553	971	Vignory, . . . . .		855
Manhattan, . . . . .		954	Warren, . . . . .		928
Mansfield, . . . . .		954	Weyanoke, . . . . .	888	. . .
Medford, . . . . .	553	972	Weymouth, . . . . .	555	972D
Middlesex, . . . . .	553	. . .	Wilton, . . . . .	555	. . .
Nahant, . . . . .	853	. . .	Woburn, . . . . .	555	972D
Nantucket, . . . . .	553	. . .	Yorktown, . . . . .	555	972D
Petersham, . . . . .		972A			

Design.	Builders' Hdw.	Cabinet Hdw.	Design.	Builders' Hdw.	Cabinet Hdw.
---------	----------------	--------------	---------	----------------	--------------

### Egyptian.

For descriptive article see pages 297 to 301.

### Elizabethan.

For descriptive article see pages 487 to 491.

Leicester, . . .	852	. . .	Stratford, . . .	491	972c
Raleigh, . . .	491	. . .	Wentworth, . . .	491	. . .

### Empire.

For descriptive article see pages 557 to 561.

Arcola, . . .	561	. . .	Marengo, . . .	561	. . .
Austerlitz, . . .	561	965	Nemours, . . .	561	. . .
Jena, . . .	561	. . .	St. Cloud, . . .	561	972c

### Early Christian.

For descriptive article see pages 363 to 367.

### English Renaissance.

For descriptive article see pages 493 to 499.

Manchester, . . .	499	971	. . . . .	. . . . .	. . . . .
-------------------	-----	-----	-----------	-----------	-----------

### Flemish Renaissance.

For descriptive article see pages 479 to 485.

Brabant, . . .	485	925	Largo, . . . .	485	970
----------------	-----	-----	----------------	-----	-----

### Francis I.

For descriptive article see pages 429 to 437.

Chambord, . . .	437	. . .	. . . . .	. . . . .	. . . . .
-----------------	-----	-------	-----------	-----------	-----------

### French Renaissance.

For descriptive article see pages 501 to 509.

Amboise, . . .	507	. . .	Biarritz, . . .	507	. . .
Anet, . . .	507	. . .	Chantilly, . . .	507	. . .
Angoulême, . . .	. . .	964	Chartres, . . .	887	. . .
Argonne, . . .	823	. . .	Como, . . . .	508	966

Design.	Builders' Hdw.	Cabinet Hdw.	Design.	Builders' Hdw.	Cabinet Hdw.
---------	----------------	--------------	---------	----------------	--------------

**French Renaissance.—Continued.**

Conde, . . . . .		926	Mentz, . . . . .	827	
Dormans, . . . . .	508	926	Oporto, . . . . .	509	972A
Dreux, . . . . .	508		Orleans, . . . . .	873	
Dunkirk, . . . . .	873		Paris, . . . . .	873	
Duro, . . . . .	508		Rennes, . . . . .		955
Epinal, . . . . .		926	Sevres, . . . . .	509	
Fermo, . . . . .	508		St. Denis, . . . . .	873	
Gordian, . . . . .	508		Toulouse, . . . . .		928
Grenoble, . . . . .	509	969	Vercelli, . . . . .	829	
Marlaix, . . . . .	873		Verzy, . . . . .	873	

**German Renaissance.**

For descriptive article see pages 461 to 469.

Bonn, . . . . .	469	965	Heidelberg, . . . . .	469	969
Dresden, . . . . .	469		Hondo, . . . . .	469	969
Hamburg, . . . . .		851	Trouville, . . . . .	873	

**Gothic.**

For descriptive article see pages 403 to 413.

(English).

Canterbury, . . . . .	412				
-----------------------	-----	--	--	--	--

(French).

Alencon, . . . . .	411	925	Epernay, . . . . .		967
Aubigny, . . . . .	847		Flavigny, . . . . .	850	
Beauvais, . . . . .	411		Gironde, . . . . .	851	
Bellas, . . . . .	873		Greenfield, . . . . .		851
Bernay, . . . . .	848		Ivry, . . . . .		970
Chalons, . . . . .	849		Nates, . . . . .	853	
Cydonia, . . . . .		850	Tours, . . . . .		972c

Design.	Builders' Hdw.	Cabinet Hdw.	Design.	Builders' Hdw.	Cabinet Hdw.
<b>Gothic—(Continued).</b>					
(German).					
Amiens, . . . .	411	. . . .	Everevx, . . . .	873	. . . .
Bennington, . . .	848	. . . .	Florensac, . . . .	412	. . . .
Brest, . . . .	849	. . . .	Granville, . . . .	851	. . . .
Caen, . . . .	. . . .	966	Kelp, . . . .	413	970
Coburg, . . . .	412	. . . .	Riva, . . . .	853	. . . .
Dippe, . . . .	850	. . . .	Saarbruck, . . . .	413	972

## (Italian).

Murano, . . . .	413	. . . .	Pisa, . . . .	853	. . . .
Pesaro, . . . .	853	. . . .	. . . .	. . . .	. . . .

**Greek.**

For descriptive article see pages 329 to 337.

Archala, . . . .	845	. . . .	Dodona, . . . .	335	. . . .
Argos, . . . .	335	964	Ephesus, . . . .	336	967
Arta, . . . .	. . . .	952	Gardo, . . . .	336	968
Athens, . . . .	335	. . . .	Larissa, . . . .	336	970
Casale, . . . .	879	. . . .	Marathon, . . . .	336	972
Corinth. . . .	335	. . . .	Miletus . . . .	337	. . . .
Cydonia, . . . .	. . . .	850	Rhodes, . . . .	337	. . . .

**Henry II.**

For descriptive article see pages 439 to 447.

Vergennes, . . . .	447	. . . .	. . . .	. . . .	. . . .
--------------------	-----	---------	---------	---------	---------

Design.	Builders' Hdw.	Cabinet Hdw.		Design.	Builders' Hdw.	Cabinet Hdw.
---------	----------------	--------------	--	---------	----------------	--------------

**Henry III.**

For descriptive article see pages 449 to 455.

**Henry IV.**

For descriptive article see pages 457 to 459.

**Indian.**

For descriptive article see pages 321 to 327.

Mandalay, . . .	327	. . .	. . . . .
-----------------	-----	-------	-----------

**Italian Renaissance.**

For descriptive article see pages 415 to 428.

Adria, . . . . .	424	. . .	Florentine, . . . . .	425	. . . . .
Ancona, . . . . .	745	. . .	Genoa, . . . . .	425	. . . . .
Arno, . . . . .	424	964	Leghorn, . . . . .	873	. . . . .
Bergamo, . . . . .	424	. .	Lodi, . . . . .	426	971
Carrara, . . . . .	. . .	926	Medici, . . . . .	426	972
Casale, . . . . .	879	. . .	Messina, . . . . .	873	. . . . .
Catania, . . . . .	424	. . .	Milan, . . . . .	426	972
Certosa, . . . . .	424	. . .	Milo, . . . . .	426	. . . . .
Ceva, . . . . .	425	. .	Modena, . . . . .	873	. . . . .
Dolphin, . . . . .	825	. . .	Monaco, . . . . .	426	972
Etrurian, . . . . .	425	. . .	Palermo, . . . . .	427	. . . . .
Fassano, . . . . .	. . .	953	Pasco, . . . . .	427	972A
Ferrara, . . . . .	425	968	Reggio, . . . . .	873	. . . . .
Firenze, . . . . .	425	968	Rialto, . . . . .	427	. . . . .

Design.	Builders' Hdw.	Cabinet Hdw.	Design.	Builders' Hdw.	Cabinet Hdw.
<b>Italian Renaissance—Continued.</b>					
Rivoli, . . . .	427	. . . .	Tivoli, . . . .	873	. . . .
Savona, . . . .	. . . .	972B	Tosca, . . . .	428	. . . .
Siena, . . . .	427	. . . .	Treviso, . . . .	428	. . . .
Taranto, . . . .	873	. . . .	Turin, . . . .	873	. . . .
Terni, . . . .	873	. . . .	Urbino, . . . .	428	972D

**Japanese.**

For descriptive article see pages 307 to 315.

Osaka, . . . .	315	972A	. . . . .	. . . . .	. . . . .
----------------	-----	------	-----------	-----------	-----------

**L'Art Nouveau.**

For descriptive article see pages 563 to 569.

Laval, . . . .	569	. . . .	. . . . .	. . . . .	. . . . .
----------------	-----	---------	-----------	-----------	-----------

**Louis XIII.**

For descriptive article see pages 511 to 515.

Antwerp, . . . .	515	. . . .	. . . . .	. . . . .	. . . . .
------------------	-----	---------	-----------	-----------	-----------

**Louis XIV.**

For descriptive article see pages 517 to 523.

Charlemont, . . . .	523	. . . .	Menin, . . . .	523	. . . .
Mailly, . . . .	. . . .	954	Versailles, . . . .	523	. . . .
Marivaux, . . . .	523	. . . .	. . . . .	. . . . .	. . . . .

**Louis XV.**

For descriptive article see pages 525 to 531.

Aix, . . . .	823	. . . .	Fleury, . . . .	531	968
Breton, . . . .	531	. . . .	Fontenoy, . . . .	531	968

Design.	Builders' Hdw.	Cabinet Hdw.	Design.	Builders' Hdw.	Cabinet Hdw.
---------	----------------	--------------	---------	----------------	--------------

**Louis XV.—Continued.**

Marly, . . . . .	531	. . . . .	Villeroi, . . . . .	531	. . . . .
Navarro, . . . . .	531	972	. . . . .	. . . . .	. . . . .

**Louis XVI.**

For descriptive article see pages 533 to 537.

Bondi, . . . . .	952	Monceaux, . . . . .	537	. . . . .	
Chatillon, . . . . .	537	926	Trianon, . . . . .	537	972c
Compiègne, . . . . .	537	. . . . .	Vareennes, . . . . .	757	. . . . .
Meaux, . . . . .	537	. . . . .	Verdun . . . . .	537	. . . . .
St. Malo, . . . . .	537	. . . . .	. . . . .	. . . . .	. . . . .

**Modern.**

For descriptive article see pages 571 to 581.

Cambria, . . . . .	581	. . . . .	Parma, . . . . .	581	. . . . .
Castilian, . . . . .	581	. . . . .	Senlis, . . . . .	581	. . . . .
Florian, . . . . .	581	968	. . . . .	. . . . .	. . . . .

**Moorish.**

For descriptive article see pages 381 to 385.

Cordova, . . . . .	385	. . . . .	Tunis, . . . . .	385	972d
--------------------	-----	-----------	------------------	-----	------

**Persian.**

For descriptive article see pages 317 to 319.

**Pompeian.**

For descriptive article see pages 347 to 353.

**Prehistoric.**

For descriptive article see pages 289 to 291.



Design.	Builders' Hdw.	Cabinet Hdw.	Design.	Builders' Hdw.	Cabinet Hdw.
<b>Romanesque.</b>					
For descriptive article see pages 391 to 401.					
Abbotsford, . . . .	397	. . . .	Durban, . . . .	850	. . . .
Agen, . . . .	847	. . . .	Duxbury, . . . .	850	. . . .
Albi, . . . .	745	. . . .	Ebro, . . . .	399	. . . .
Aspremont, . . . .	847	. . . .	Elne, . . . .	. . . .	967
Aumont, . . . .	. . . .	964	Foix, . . . .	850	. . . .
Aurillac, . . . .	823	. . . .	Gueret, . . . .	873	. . . .
Auvergne, . . . .	397	965	Jarnac, . . . .	. . . .	970
Bayonne, . . . .	. . . .	848	Lagrasse, . . . .	. . . .	970
Beaucaire, . . . .	848	. . . .	Lyons, . . . .	399	971
Beaumont, . . . .	398	. . . .	Melun, . . . .	852	. . . .
Beauvoir, . . . .	. . . .	965	Margaux, . . . .	400	. . . .
Belfort, . . . .	398	925	Montauban, . . . .	. . . .	972
Bergerac, . . . .	824	. . . .	Montins, . . . .	853	. . . .
Bordeaux, . . . .	398	. . . .	Murat, . . . .	. . . .	853
Brionde, . . . .	849	. . . .	Narbonne, . . . .	827	. . . .
Cherbourg, . . . .	849	. . . .	Nevers, . . . .	827	. . . .
Clermont, . . . .	. . . .	966	Nimes, . . . .	400	. . . .
Cluny, . . . .	398	963	Novara, . . . .	853	. . . .
Dax, . . . .	. . . .	967	Pau, . . . .	853	. . . .
Donjon, . . . .	850	. . . .	Prades, . . . .	853	. . . .
Douvaine, . . . .	399	. . . .	Realmont, . . . .	400	972B
Duranno, . . . .	850	. . . .	Rodez, . . . .	854	. . . .

Design.	Builders' Hdw.	Cabinet Hdw.	Design.	Builders' Hdw.	Cabinet Hdw.
---------	----------------	--------------	---------	----------------	--------------

**Romanesque.—Continued.**

Rokeby, . . . .	401 . . . .		Tarbes, . . . .	854 . . . .	
Roquefort, . . . .	854 . . . .		Touraine, . . . .	401 . . . .	
Royat, . . . .	854 . . . .		Tulle, . . . .	855 . . . .	
Salignac, . . . .	854 . . . .		Valence, . . . .		972D

**Roman.**

For descriptive article see pages 339 to 345.

Tiber, . . . .	345 . . . .	972c   . . . . .
----------------	-------------	------------------

**Saracenic.**

For descriptive article see pages 369 to 373.

**Savage Tribes.**

For descriptive article see pages 293 to 295.

**Spanish Renaissance.**

For descriptive article see pages 471 to 477.

Alcazar, . . . .	477 . . . .	963   . . . . .
------------------	-------------	-----------------

**Turkish.**

For descriptive article see pages 387 to 389.

## Index Arranged Alphabetically.

### YALE & TOWNE DESIGNS.

For arrangement by *Schools* see page 236.

*The Multipliers given in the list below indicate the relative prices of the various Designs in Copper Finish (CX22, CY22, CZ17), as compared with prices in the Cluny Design in same finish. Where designs are not furnished in Copper, the finish used for comparison is stated in each case.*

Design.	School.	Multi-plier.	Builders' Hardware Page.	Store Door Set Page.	Cabinet Hardware. Page.
Abbottsford, .	Romanesque, . . .	2.00	397	745	. . .
Adams, . . .	Colonial, . . . .	7.60	548	745	963
Adria, . . .	Italian Renaissance, .	3.20	424	759	. . .
Agen, . . .	Romanesque, . . .	*	847	. . .	. . .
Aix, . . .	Louis XV, . . . .	*	823	. . .	. . .
Albi, . . .	Romanesque, . . .	*	. . .	745	. . .
Alcazar, . .	Spanish Renaissance,	2.00	477	. . .	963
Alencon, . .	Gothic, . . . .	1.75	411	745	925
Amboise, . .	French Renaissance, .	1.40	507	745	. . .
Amherst, . .	Colonial, . . . .	2.80	548	745	964
Amiens, . .	Gothic, . . . .	12.00	411	. . .	. . .
Ancona, . .	Italian Renaissance, .	*	. . .	745	. . .
Andover, . .	Colonial, . . . .	*	873	. . .	. . .
Anet, . . .	French Renaissance, .	3.00	507	. . .	. . .
Angouleme, .	French Renaissance,	3.00	. . .	. . .	964
Annapolis, .	Colonial, . . . .	.70	. . .	. . .	964
Antwerp, . .	Louis XIII . . . .	2.30	515	745	. . .
Arcadian, . .	Colonial, . . . .	.30	548	759	925

\* List prices given.

Design.	School.	Multiplier.	Builders' Hardware. Page.	Store Door Set. Page.	Cabinet Hardware. Page.
Archala, . . .	Greek, . . . . .	*	847	. . . .	. . . .
Arcola, . . .	Empire, . . . . .	4.50	561	. . . .	. . . .
Argonne, . . .	French Renaissance,	*	823	. . . .	. . . .
Argos, . . .	Greek, . . . . .	1.70	335	. . . .	964
Arlington, . . .	Colonial, . . . . .	1.10	548	745	. . . .
Arno, . . .	Italian Renaissance, .	.25†	424	745	964
Arta, . . .	Greek, . . . . .	. . . .	. . . .	. . . .	952
Aspremont, . . .	Romanesque, . . . . .	*	847	. . . .	. . . .
Athens, . . .	Greek, . . . . .	1.70	335	. . . .	. . . .
Aubin, . . .	Colonial, . . . . .	1.30	. . . .	. . . .	964
Aubigny, . . .	Gothic, . . . . .	*	847	. . . .	. . . .
Aumont, . . .	Romanesque, . . . . .	1.40	. . . .	. . . .	964
Aurillac, . . .	Romanesque, . . . . .	*	823	. . . .	. . . .
Austerlitz, . . .	Empire, . . . . .	1.50	561	747	965
Auvergne, . . .	Romanesque, . . . . .	1.40	397	747	965
Bayonne, . . .	Romanesque, . . . . .	*	. . . .	. . . .	848
Beaucaire, . . .	Romanesque, . . . . .	*	848	. . . .	. . . .
Beaumont, . . .	Romanesque, . . . . .	2.20	398	. . . .	. . . .
Beauvais, . . .	Gothic, . . . . .	1.50†	411	747	. . . .
Beauvoir, . . .	Romanesque, . . . . .	2.60	. . . .	. . . .	965
Belfort, . . .	Romanesque, . . . . .	1.20	398	. . . .	925
Bellas, . . .	Gothic, . . . . .	*	873	. . . .	. . . .

\* List prices given. † Bower-Barff Finish on Iron. ‡ Copper Plated on Iron.

Design.	School.	Multi-plier.	Builders' Hardware. Page.	Store Door Set. Page.	Cabinet Hardware Page.
Bennington, .	Gothic, . . . .	*	848	. . .	. . .
Bergamo, .	Italian Renaissance, .	2.75	424	747	. . .
Bergerac, .	Romanesque, . . .	*	824	. . .	. . .
Bernay, . .	Gothic, . . . .	*	848	. . .	. . .
Beverly, . .	Colonial, . . . .	3.40	. . .	. . .	965
Biarritz, . .	French Renaissance,	2.20	507	. . .	. . .
Bondi, . .	Louis XVI, . . . .	. . .	. . .	. . .	952
Bonn, . .	German Renaissance,	1.40	469	747	965
Bordeaux, . .	Romanesque, . . .	3.80	398	747	. . .
Bothnian, . .	Colonial, . . . .	.30	549	. . .	. . .
Bourg, . .	Colonial, . . . .	*	549	. . .	. . .
Boylston, . .	Colonial, . . . .	. . .	. . .	. . .	952
Brabant, . .	Flemish, . . . .	2.20	485	747	925
Brest, . .	Gothic, . . . .	*	849	. . .	. . .
Breton, . .	Louis XV, . . . .	1.90	531	. . .	. . .
Brionde, . .	Romanesque, . . .	*	849	. . .	. . .
Bristol, . .	Colonial, . . . .	1.00	549	759	965
Brockton, . .	Colonial, . . . .	.95	. . .	. . .	966
Brunswick, . .	Colonial, . . . .	1.00	549	747	. . .
Burlington, . .	Colonial, . . . .	1.10	549	. . .	. . .
Caen, . .	Gothic, . . . .	2.00	. . .	. . .	966
Cambria, . .	Modern, . . . .	2.40	581	. . .	. . .
Cambridge, . .	Colonial, . . . .	. . .	. . .	. . .	926

\* List prices given.

Design.	School.	Multi-plier.	Builders' Hardware. Page.	Store Door Set. Page.	Cabinet Hardware. Page.
Canterbury, .	Gothic, . . . .	3.10	412	749	. . . .
Carrara, . .	Italian Renaissance, . . . .	. . . .	. . . .	. . . .	926
Casale, . .	Greek, . . . .	. . . .	879	. . . .	. . . .
Casale, . .	Italian Renaissance, . . . .	. . . .	879	. . . .	. . . .
Castillan, .	Modern, . . . .	.25§	581	. . . .	. . . .
Catania, . .	Italian Renaissance, . . . .	3.20	424	749	. . . .
Certosa, . .	Italian Renaissance, . . . .	2.80	424	. . . .	. . . .
Ceva, . . .	Italian Renaissance, . . . .	3.50	425	749	. . . .
Chalons, . .	Gothic, . . . .	*	849	. . . .	. . . .
Chambord, .	Francis I, . . . .	3.70	437	. . . .	. . . .
Chantilly, .	French Renaissance, . . . .	2.20	507	. . . .	. . . .
Charlemont, .	Louis XIV, . . . .	1.30†	523	. . . .	. . . .
Chartres, . .	French Renaissance, . . . .	*	887	. . . .	. . . .
Chatillon, .	Louis XVI, . . . .	3.90†	537	. . . .	926
Cherbourg, .	Romanesque, . . . .	*	849	. . . .	. . . .
Chester, . .	Colonial, . . . .	1.00	549	. . . .	966
Clermont, . .	Romanesque, . . . .	1.20	. . . .	. . . .	966
Cluny, . . .	Romanesque, . . . .	*	398	747	963
Coburg, . . .	Gothic, . . . .	1.50‡	412	. . . .	. . . .
Cohasset, . .	Colonial, . . . .	. . . .	. . . .	. . . .	953
Colonna, . .	Colonial, . . . .	1.00	550	749	966
Como, . . .	French Renaissance, . . . .	.85	508	. . . .	966
Compiègne, .	Louis XVI, . . . .	3.20	537	. . . .	. . . .

\* List prices given. † Brass, Buffed. ‡ Bower-Barff on Iron. § Copper Plated on Steel

Design.	School.	Multi-plier.	Builders' Hardware. Page	Store Door Set. Page	Cabinet Hardware. Page.
Concord, . . .	Colonial, . . . .	1.90	. . . .	. . . .	967
Conde, . . .	French Renaissance,	. . . .	. . . .	. . . .	926
Cordova, . . .	Moorish, . . . .	2.20	385	. . . .	. . . .
Corinth, . . .	Greek, . . . .	1.40	335	. . . .	. . . .
Cydonia, . . .	French Renaissance,	*	. . . .	. . . .	850
Dax, . . . .	Romanesque, . . .	1.00	. . . .	. . . .	967
Dedham, . . .	Colonial, . . . .	1.40	550	. . . .	926
Deerfield, . .	Colonial, . . . .	1.60†	550	. . . .	. . . .
Derby, . . . .	Colonial, . . . .	1.80	. . . .	. . . .	967
Dieppe, . . . .	Gothic, . . . .	*	850	. . . .	. . . .
Dodona, . . . .	Greek, . . . .	2.00	335	749	. . . .
Dolphin, . . .	Italian Renaissance, .	*	825	. . . .	. . . .
Donjon, . . . .	Romanesque, . . .	*	850	. . . .	. . . .
Dorchester, . .	Colonial, . . . .	1.20	550	. . . .	. . . .
Dorian, . . . .	Colonial, . . . .	.30	551	. . . .	. . . .
Dormans, . . .	French Renaissance,	1.40	508	. . . .	926
Douvaine, . . .	Romanesque, . . .	*	399	749	. . . .
Dover, . . . .	Colonial, . . . .	. . . .	. . . .	. . . .	953
Dresden, . . .	German Renaissance,	2.60	469	749	. . . .
Dreux, . . . .	French Renaissance,	1.60	508	. . . .	. . . .
Dunkirk, . . .	French Renaissance,	*	873	. . . .	. . . .
Duranno, . . .	Romanesque, . . .	*	850	. . . .	. . . .
Durban, . . . .	Romanesque, . . .	*	850	. . . .	. . . .

\* List prices given. † Bower-Barff on Iron.

Designs	School.	Multi-plier.	Builders' Hardware. Page.	Store Door Set. Page.	Cabinet Hardware. Page.
Duro, . . .	French Renaissance,	.25†	508	749	. . .
Duxbury, . . .	Romanesque, . . .	*	850	. . .	. . .
Ebro, . . .	Romanesque, . . .	.25†	399	. . .	. . .
Elne, . . .	Romanesque, . . .	1.30	. . .	. . .	967
Epernay, . . .	Gothic, . . . . .	1.80	. . .	. . .	967
Ephesus, . . .	Greek, . . . . .	1.70	336	749	967
Epinal, . . .	French Renaissance,	. . .	. . .	. . .	926
Etrurian, . . .	Italian Renaissance, .	.50	425	. . .	. . .
Evereux, . . .	Gothic, . . . . .	*	873	. . .	. . .
Exeter, . . .	Colonial, . . . . .	. . .	. . .	. . .	926
Fairfax, . . .	Colonial, . . . . .	2.60	551	749	967
Fassano, . . .	Italian Renaissance, .	. . .	. . .	. . .	953
Fermo, . . .	French Renaissance,	.85	508	. . .	. . .
Ferrara, . . .	Italian Renaissance, .	3.25	425	. . .	968
Firenze, . . .	Italian Renaissance, .	2.20	425	. . .	968
Flavigny, . . .	Gothic, . . . . .	*	850	. . .	. . .
Fiery, . . .	Louis XV, . . . . .	1.20	531	751	968
Florensac, . . .	Gothic, . . . . .	3.00	412	751	. . .
Florentine, . . .	Italian Renaissance, .	.52†	425	. . .	. . .
Florian, . . .	Modern, . . . . .	.25‡	581	759	968
Foix, . . .	Romanesque, . . . . .	*	850	. . .	. . .
Fontenoy, . . .	Louis XV, . . . . .	2.70	531	. . .	968

\* List prices given.

† Bower-Barff on Iron.

‡ Copper Plated on Iron.

§ Bronze, ebonized Matte.



Design.	School.	Multi-plier.	Builders' Hardware. Page.	Store Door Set. Page.	Cabinet Hardware. Page.
Fronsac, . .	Byzantine, . . . .	1.00	. . . .	. . . .	361
Gardo, . .	Greek, . . . .	.70	336	751	968
Genoa, . .	Italian Renaissance, .	1.10	425	751	. . . .
Germantown,	Colonial, . . . .	. . . .	. . . .	. . . .	954
Gironde, . .	Gothic, . . . .	*	851	. . . .	. . . .
Gordian, . .	French Renaissance,	.65	508	. . . .	. . . .
Granville, .	Gothic, . . . .	*	851	. . . .	. . . .
Greenfield, .	Gothic, . . . .	*	. . . .	. . . .	851
Grenoble, .	French Renaissance,	.95	509	. . . .	969
Gueret, . .	Romanesque, . .	*	873	. . . .	. . . .
Guilford, . .	Colonial, . . . .	1.30	551	. . . .	. . . .
Hadley, . .	Colonial, . . . .	. . . .	551	. . . .	. . . .
Hamburg, . .	German Renaissance,	*	. . . .	. . . .	851
Hartford, . .	Colonial, . . . .	. . . .	. . . .	. . . .	927
Heidelberg, .	German Renaissance,	2.80	469	. . . .	969
Hellenian, . .	Colonial, . .	.35	551	759	969
Hingham, . .	Colonial, . . . .	1.10	552	751	969
Hondo, . .	German Renaissance,	.85	469	751	969
Ionian, . .	Colonial, . . . .	.35	552	759	969
Ipswich, . .	Colonial, . . . .	. . . .	552	. . . .	. . . .
Ituno, . .	Colonial, . . . .	.75	552	. . . .	969
Ivry, . . .	Gothic, . . . .	4.50	. . . .	. . . .	970
Jamestown, .	Colonial, . . . .	2.00	552	. . . .	927
Jarnac, . .	Romanesque, . . . .	1.20	. . . .	. . . .	970

\* List prices given.

Design.	School.	Multi-plier.	Builders' Hardware. Page.	Store Door Set. Page.	Cabinet Hardware. Page.
Jena, . . .	Empire, . . .	1.90	561	751	. . .
Jennico, . . .	Colonial, . . .	.25†	552	. . .	970
Kelp, . . .	Gothic, . . .	1.30	413	751	970
Lagrasse, . . .	Romanesque, . . .	1.00	. . .	. . .	970
Lancaster, . . .	Colonial, . . .	*	887	. . .	. . .
Largo, . . .	Flemish, . . .	.80	485	759	970
Larissa, . . .	Greek, . . .	.90	336	751	970
Laval, . . .	L'Art Nouveau, . . .	2.90†	569	. . .	. . .
Leghorn, . . .	Italian Renaissance, . . .	*	873	. . .	. . .
Leicester, . . .	Elizabethan, . . .	*	852	. . .	. . .
Lexington, . . .	Colonial, . . .	2.00	. . .	. . .	971
Libourne, . . .	Byzantine, . . .	*	. . .	753	. . .
Lodi, . . .	Italian Renaissance, . . .	2.20	426	753	971
Louisburg, . . .	Colonial, . . .	. . .	. . .	. . .	954
Lowell, . . .	Colonial, . . .	1.10	. . .	. . .	971
Lynn, . . .	Colonial, . . .	1.00	553	753	971
Lyons, . . .	Romanesque, . . .	1.40	399	. . .	971
Maily, . . .	Louis XIV, . . .	. . .	. . .	. . .	954
Manchester, . . .	English Renaissance, . . .	2.30	499	. . .	971
Mandalay, . . .	Indian. . . . .	2.20	327	. . .	. . .
Manhattan, . . .	Colonial, . . .	. . .	. . .	. . .	954
Mansfield, . . .	Colonial, . . .	. . .	. . .	. . .	954
Marathon, . . .	Greek, . . .	1.00	336	759	972

\* List prices given. † Brass, Buffed. ‡ Copper Plated on Iron.

Design.	School.	Multiplier.	Builders' Hardware. Page.	Store Door Set. Page.	Cabinet Hardware. Page.
Marengo, . .	Empire, . . . .	1.50	561	753	. . . .
Margaux, . .	Romanesque, . .	1.40	400	. . . .	. . . .
Marivaux, . .	Louis XIV, . . . .	3.25	523	. . . .	. . . .
Marlaix, . . .	French Renaissance,	*	873	. . . .	. . . .
Marly, . . . .	Louis XV, . . . .	2.60	531	753	. . . .
Meaux, . . . .	Louis XVI, . . . .	2.70	537	. . . .	. . . .
Medford, . . .	Colonial, . . . .	1.40	553	. . . .	972
Medici, . . . .	Italian Renaissance, .	2.00	426	753	972
Melun, . . . .	Romanesque, . . . .	*	852	. . . .	. . . .
Menin, . . . .	Louis XIV, . . . .	3.00	523	. . . .	. . . .
Mentz, . . . .	French Renaissance,	*	827	. . . .	. . . .
Messina, . . .	Italian Renaissance, .	*	873	. . . .	. . . .
Middlesex, . .	Colonial, . . . .	3.00	553	. . . .	. . . .
Milan, . . . .	Italian Renaissance, .	2.60	426	753	972
Miletus, . . . .	Greek, . . . .	2.10	337	753	. . . .
Milo, . . . .	Italian Renaissance, .	*	426	753	. . . .
Modena, . . . .	Italian Renaissance, .	*	873	. . . .	. . . .
Monaco, . . . .	Italian Renaissance, .	.25†	426	760	972
Monceaux, . .	Louis XVI, . . . .	1.25	537	759	. . . .
Montauban, . .	Romanesque, . . . .	1.10	. . . .	. . . .	972
Montins, . . . .	Romanesque, . . . .	*	853	. . . .	. . . .
Murano, . . . .	Gothic, . . . .	2.10	413	. . . .	. . . .
Murat, . . . .	Romanesque, . . . .	*	. . . .	. . . .	853

\* List prices given. † Copper Plated on Iron.

Design	School.	Multi-plier.	Builders' Hardware. Page.	Store Door Set. Page.	Cabinet Hardware. Page.
Abiant,	Colonial,	*	853		
Abantes,	Gothic,	*	853		
Abantucket,	Colonial,	3.40	553		
Acarbonne,	Romanesque,	*	827		
Acavaro,	Louis XV.	.65	531	760	972
Acemours,	Empire,	1.60†	561	760	
Aceters,	Romanesque,	*	827		
Acemes,	Romanesque,	2.40	400	753	
Acivara,	Romanesque,	*	853		
Acobato,	French Renaissance,	.90	509		972A
Acoleans,	French Renaissance,	*	873		
Acosaka,	Japanese,	3.00	315		972A
Acaperno,	Italian Renaissance,	3.00	427		
Acans,	French Renaissance,	*	873		
Acapma,	Modern,	1.40	581	755	
Acapaco,	Italian Renaissance,	.25†	427		972A
Acapu,	Romanesque,	*	853		
Acapato,	Gothic,	*	853		
Acapetsham,	Colonial,	1.40			972A
Acapiedmont,	Colonial,	1.00	553		972A
Acapisa,	Gothic,	*	853		
Acapimouth,	Colonial,	.80†	554	755	972B

\* List prices given. † Copper Plated on Iron. ‡ Bower-Barff on Iron

Design.	School.	Multi-plier.	Builders' Hardware. Page.	Store Door Set. Page.	Cabinet Hardware. Page.
Portsmouth, .	Colonial, . . . . .				928
Prades, . .	Romanesque, . .	*	853		
Putnam, . .	Colonial, . . . . .				928
Raleigh, . .	Elizabethan, . . .	2.30	491		
Realmont, .	Romanesque, . . .	1.30	400	755	972B
Reggio, . .	Italian Renaissance, .	*	873		
Rennes, . .	French Renaissance, . . .				955
Revere, . .	Colonial, . . . . .				928
Rhodes, . .	Greek, . . . . .	1.40	337	755	
Rialto, . .	Italian Renaissance, .	2.80	427		
Riva, . .	Gothic, . . . . .	*	853		
Rivoli, . .	Italian Renaissance, .	4.60	427	755	
Roanoke, . .	Colonial, . . . . .	1.50	554	755	972B
Rodez, . .	Romanesque, . . .	*	854		
Rokeby, . .	Romanesque, . . .	1.40	401	760	
Roquefort, .	Romanesque, . . .	*	854		
Royat, . .	Romanesque, . . .	*	854		
Saarbruck, .	Gothic, . . . . .	2.60	413		972B
Salem, . .	Colonial, . . . . .	1.70	554	755	972B
Salignac, . .	Romanesque, . . .	*	854		
Savona, . .	Italian Renaissance, .	.90			972B
Saybrook, .	Colonial, . . . . .				955
Senlis, . .	Modern, . . . . .	3.00	581	755	

\* List prices given.

Design.	School.	Multiplier.	Builders' Hardware. Page.	Store Door Set. Page.	Cabinet Hardware. Page.
Sentis, . . .	Colonial, . . . . .	1.10	554	755	. . . .
Sevres, . . .	French Renaissance, .	2.50	509	755	. . . .
Siena, . . .	Italian Renaissance, .	2.40	427	757	. . . .
Sparta, . . .	Colonial, . . . . .	1.20	554	755	972B
St. Cloud, . .	Empire, . . . . .	3.25	561	. . . .	972C
St. Denis, . .	French Renaissance,	*	873	. . . .	. . . .
St. Malo, . .	Louis XVI, . . . . .	2.40	537	. . . .	. . . .
Stonington . .	Colonial, . . . . .	.75	555	. . . .	. . . .
Strabo, . . .	Colonial, . . . . .	. . . .	. . . .	. . . .	955
Stratford, . .	Elizabethan, . . . . .	3.20	491	760	972C
Taranto, . . .	Italian Renaissance, .	*	873	. . . .	. . . .
Tarbes, . . .	Romanesque, . . . . .	*	854	. . . .	. . . .
Terni, . . . .	Italian Renaissance, .	*	873	. . . .	. . . .
Tiber, . . . .	Roman, . . . . .	2.20	345	. . . .	972C
Tivoli, . . . .	Italian Renaissance, .	*	873	. . . .	. . . .
Torcello, . . .	Byzantine, . . . . .	*	. . . .	757	. . . .
Tosca, . . . .	Italian Renaissance, .	2.25	428	757	. . . .
Toulon, . . . .	Colonial, . . . . .	1.30	. . . .	. . . .	972C
Toulouse, . . .	French Renaissance,	. . . .	. . . .	. . . .	928
Touraine, . . .	Romanesque, . . . . .	1.30	401	757	. . . .
Tours, . . . .	Gothic, . . . . .	1.30	. . . .	. . . .	972C
Traves, . . . .	Colonial, . . . . .	1.30	. . . .	. . . .	972C
Trento, . . . .	Colonial, . . . . .	*	873	. . . .	. . . .
Trenton, . . . .	Colonial, . . . . .	. . . .	. . . .	. . . .	955

\* List prices given.

Design.	School.	Multi-plier.	Builders' Hardware. Page.	Store Door Set Page.	Cabinet Hardware Page.
Treviso, . . .	Italian Renaissance, . . .	4.50	428	757	. . .
Trianon, . . .	Louis XVI, . . .	2.90	537	757	972D
Tulle, . . .	Romanesque, . . .	*	855	. . .	. . .
Tunis. . .	Moorish, . . .	2.20	385	. . .	972D
Trouville, . . .	German Renaissance, . . .	*	873	. . .	. . .
Turin, . . .	Italian Renaissance, . . .	*	873	. . .	. . .
Urbino, . . .	Italian Renaissance, . . .	2.00	428	757	972D
Vancluse, . . .	Colonial, . . .	*	855	. . .	. . .
Valence, . . .	Romanesque, . . .	1.20	. . .	. . .	972D
Varennes . . .	Louis XVI, . . .	*	. . .	757	. . .
Vercelli, . . .	French Renaissance, . . .	*	829	. . .	. . .
Verdun, . . .	Louis XVI, . . .	. . .	537	. . .	. . .
Vergennes, . . .	Henry II, . . .	2.25	447	. . .	. . .
Versailles. . .	Louis XIV, . . .	3.40	523	757	. . .
Verzy, . . .	French Renaissance, . . .	*	873	. . .	. . .
Vignory, . . .	Colonial, . . .	*	855	. . .	. . .
Villeroi, . . .	Louis XV, . . .	3.50	531	. . .	. . .
Warren, . . .	Colonial, . . .	. . .	. . .	. . .	928
Wentworth, . . .	Elizabethan, . . .	3.50	491	757	. . .
Weyanoke, . . .	Colonial, . . .	*	888	. . .	. . .
Weymouth, . . .	Colonial, . . .	2.00	555	. . .	972D
Wilton, . . .	Colonial, . . .	2.70	555	. . .	. . .
Woburn, . . .	Colonial, . . .	2.60†	555	. . .	. . .
Yorktown, . . .	Colonial, . . .	1.00	555	. . .	972D

\* List prices given.

† Brass, Buffed.

## Preface.

**H**E who takes up the study of ornament finds himself at once in a garden which he has formerly only viewed over the hedge. He cannot fail to pick some of the best things, and he cannot pick them all.

Several of the following articles were first written some years ago, at the request of Mr. Henry R. Towne, to supply what had, in his and the writer's opinion, long been lacking, *i. e.*, a brief description of the various styles which ornamentalists in all times and countries have adopted or evolved. To these few articles many more have recently been added and the series more fully illustrated. Done at intervals and as opportunity offered, although re-written several times, the writer is aware that they may be improved, but they must now go forth as they stand, and are offered not expecting that they will escape criticism, but in the hope that some students may find through them the path of designing a little less overgrown, and that the layman may be saved some perplexities. If they are used, not to perpetuate the styles, but to assist in devising ornament appropriate to the times in which it is used, they will have been of some value.

W. W. KENT.



# Bibliography.

## AUTHORS AND WORKS CONSULTED.

- Prehistoric Art, Thomas Wilson—Annual Report Smithsonian Institution, 1896.  
History of Art, Lübke.  
Grammar of Ornament, Owen Jones.  
L'Art Pour Tous.  
Art of the Saracens in Egypt, Lane-Poole.  
Roman Remains, Piranesi.  
Early Christian Art in Ireland, Stokes.  
Century Dictionary, Century Co.  
Architecture and Sculpture in France, Noé.  
Elizabethan Architecture, Shaw.  
Mansions of England, Nash.  
Studies from Old English Mansions, Richardson.  
The Renaissance in Italy, Symonds.  
Style Empire, Percier & Fontaine.  
Le Meuble, De Champeaux.  
The Application of Ornament, Day.  
Nature in Ornament, Day.  
The Columbian Encyclopædia.  
Dictionary of Christian Antiquities, Smith & Cheetham.  
Dalmatia, the Quernaro and Istria, Jackson.  
Motifs Historiques, Daly.  
Dictionary of Art and Archæology, Mollet.  
History of Indian and Eastern Architecture, Fergusson.  
The Renaissance under the Valois, Mathews.  
Renaissance Architecture and Ornament in Spain, Prentice.  
L'Art Arabe, Prisse d'Avesnes.  
Ancient Ornamental Architecture, Tatham.  
Illustrations of the History of Art, Koehler.  
Regles des Cinq Ordres d'Architecture, Vignola, by Blondel, 1752.  
Das Deutsche Zimmer, Hirth.  
Arte Italiana, Ongania.

- L'Art, MacMillan & Co., New York.  
Dictionary of Painters, Engravers, &c., Spooner.  
Materiaux et Documents d'Architecture, Ragueneau.  
Mycenæ, Schliemann.  
The Viking Age, Du Chaillu.  
Old Colonial Architecture, Wallis.  
The Georgian Period, American Architect.  
Old Colonial Details, Goforth & McAuley.  
Portfolios of Colonial Architecture, Soderholtz.  
Indian Domestic Architecture and special photographs, Lockwood De Forest.  
Romanesque Architecture of Southern France, Revoil.  
L'Architecture Romane, Corroyer.  
L'Antiche Lucerne Sepolcrali, Bartoli.  
Ornamente aller Klassischen Kunstepochen, Zahn.  
Les Styles of Francais, Lechevallier-Chevignard.  
L'Art Architectural En France, Rouyer et Darcel.  
Furniture and Woodwork, Pollen.  
Architectural Review, London.  
Cours d'Architecture, Daviler.  
Historic Ornament, Glazier.  
Art Journal, D. Appelton & Co.

In addition to the preceding, the author wishes to acknowledge his great indebtedness to Mr. Lockwood DeForest, Mr. Otto H. Bacher, Mr. W. B. Van Ingen, Mr. Tudor Jenks, Mrs. A. E. Stratton, Mr. H. T. Schladermundt, Mr. T. Henry Randall, Prof. Wm. H. Goodyear, Mr. Reginald Bloomfield's History of Renaissance Architecture in England, The American Architect, the Brochure Series, Messrs. D. Appleton & Co., Messrs. MacMillan & Co., The Engineering Record, and Architecture and Building for the loan of sketches, books and plates.

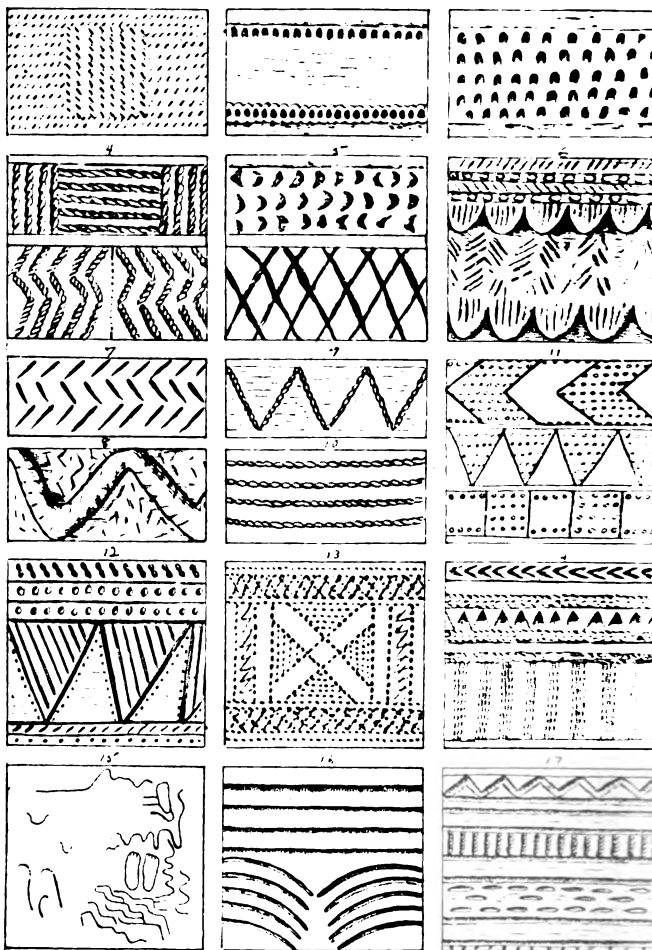

Geometric Decorative Designs in use in Western Europe during the Neolithic Period, some of which were continued into the Bronze Age

# Prehistoric.

Art of the Cave Dwellers, Paleolithic and Neolithic periods.  
Mound Builders and Aztecs.



Stone Implements.

HE decorative art of prehistoric man is most interesting in this, that certain first evidences of it are closer to nature than are any of the early examples of historical decoration which we possess. The drawings of the cave bear, mammoth and other animals found on stone, ivory and bone in the caves of Western Europe, are surprisingly direct and lifelike. They are not like sketches made by children, but by artists of ability, and as drawings of animal forms are astonishing. Pure prehistoric ornamental motifs other than animal forms are the Swastika, that mysterious, symbolic design found in almost all places where man has set his foot, and dots, zigzags or chevrons, circles and other rudimentary forms.

In America the ornament of the Mound Builders is seen on tablets of stone and on copper plates, etc. The further South we go toward Mexico and Aztec territory, the more elaborate and frequent becomes the ornament, and in the latter countries the objects of gold and pottery are sometimes very interesting examples of a period which however cannot be called savage or purely prehistoric, as we know something of the history of some of the early inhabitants, and that they were in many ways civilized. Numerous books



Pendant, with  
Decoration of  
Zigzag Points.



Ornaments used in Western Europe during Neolithic and Bronze Ages.

treat of these discoveries, and certain authors are referred to in the list of references.

Very queer prehistoric ornaments are the slight gouge marks made by the finger nail on the soft clay vessels before baking, and a similar effect is seen again in the peasant carvings of France and Germany made by the steel gouge in imbricated patterns. The drill was early known by prehistoric man, and in Early Christian ornament also the Italian stone carvers used it largely to emphasize the modeling of frieze and capital.

One of the early potters' methods of making cooking utensils may have led to the use of the basket pattern. Early man made pots for boiling out of osiers, and covered them with clay to resist fire when filled with water. The clay taking the impression of the wicker work may have suggested the use of the pattern for decoration. It is known that Western Indians in the United States improved upon this and use certain grasses to make cooking utensils, and these not only stand fire but are also water tight.

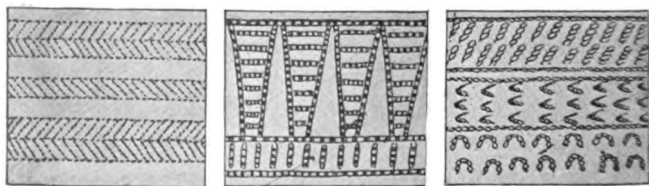

Ornaments used in Western Europe during Neolithic and Bronze Ages.



Detail of Ornamented Cast Boss  
on Bell Mouth of Irish War  
Horn. Diameter  $7\frac{1}{2}$  ins.

We find from various objects that man during the paleolithic, neolithic and bronze ages down to the present day, has decorated not only those articles which were intended primarily for ornament, but the utensils which were made solely for practical every-day use.

The more we learn of prehistoric art through its relics and remains, the

more we are instructed that the æsthetic sense of man demanded and received gratification almost coincidentally with the satisfying of his actual wants. The hunter and the artist were one. It was bound to be so, inasmuch as the keen powers of observation constantly fostered by the chase would not be denied the pleasure of recording its incidents, and from this pictorial art came the habit of imitating all forms in nature.

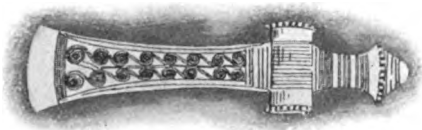

Prehistoric Swedish Bronze Axe with Spiral Ornament.



## Savage Tribes.

Polynesian, Northern and Central American, African and Oriental.



Club, Eastern Archipelago.

In all the ornament of primitive man, as exemplified in the work of Savages, there is to be noted a great dependence on the suggestions which come from the mechanical processes, such as weaving, basket work, etc., and also from the celebration of religious and other rites, of which they desire to make some record.

Thus, the Fiji Islanders and the South African tribes use the basket and weaving patterns in great variety, and possibly the fire-worshippers have left us what is supposed to be the origin of the Greek fret and all meander patterns in a small unit of design before mentioned, which came, it is claimed, from the rough representation of a flame on a rapidly whirled torch, known as the Swastika, *i. e.*, lucky mark, also in other forms as the gammadion or fylfot.

Besides this, however, we find parallel lines used alone in various ways and in connection with dots, circles and geometrical figures generally, as in the painted paper pulp work or tappa of the South Sea Islanders.

Objects in nature have undoubtedly exercised a great influence on the design-



Top of Paddle.





Canoe Ornaments, New Guinea.

we find proof of in the savage work, which is natural, as man only turned to the soil and its products when he gradually dropped hunting and began cultivating land and getting closer

ers of an early time. The moon in its full and crescent, the waves of the sea, and the various whorls, etc., of the Egyptian and Irish work are good examples of this, although the latter are also said to be taken from the Irish trumpet or horn. Foliage, trees, vines and grass seem to have had a greater attraction as motives for design to men of a later date, and more vivid imaginations than



Weapons from the Congo



Carved Box to hold Feathers,  
New Zealand.

and closer to the flora about him.

Savage art, particularly the ornamental and pictorial, finds expression in much the same forms that children use, and these often are wonderfully effective from their very simplicity and directness. A dot means a man's eye, and a waving curling line smoke, or twisted into a volute, the crest of a wave.

Through human tradition then, we constantly run across the rudiments and motives of savage ornament in the work of all nations and schools, the dot, the interlace, the chevron, the basket pattern and the fret being among the most common to all periods and styles.

Hence, for example, in a Renaissance design, the interlace which may be used, may lead the uninformed to pronounce it Byzantine, whereas it is only a Renaissance adaptation from the Byzantine. Upon reflection we see that it is very natural to find in later schools the forms common to earlier, just as we trace the looks of the parents in children, and a little careful study and observation enable a layman to distinguish the points indicating the school to which any design belongs.

Through human tradition then, we constantly run across the rudiments and motives of



Idol and Wooden Pillow,  
New Guinea.

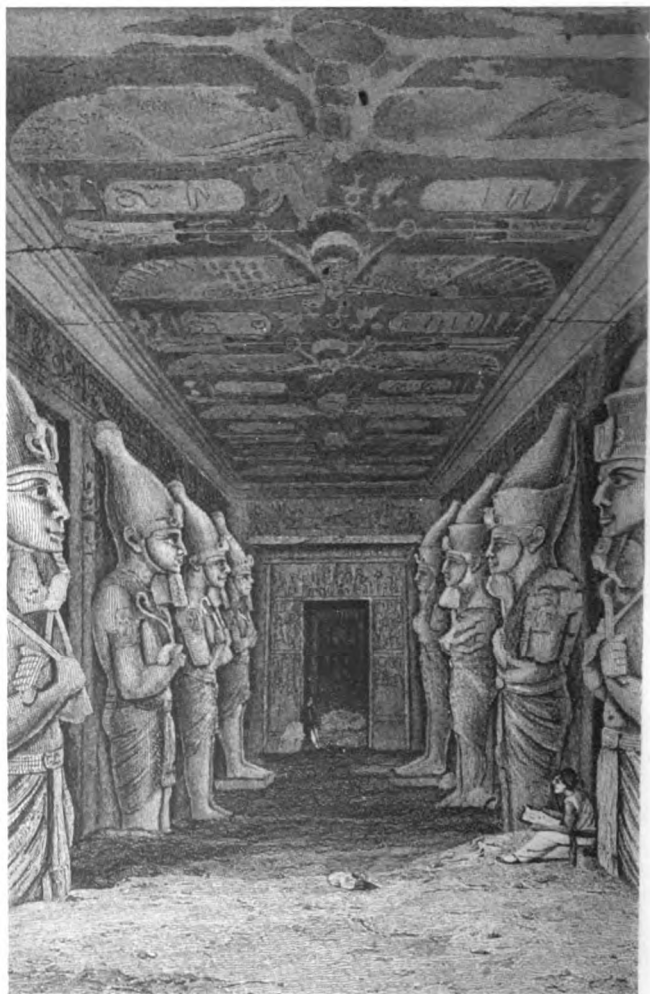

Specs of Phri, at Abou-Sembil, Nubia.

# Egyptian.

Dealing chiefly with its later phases, the earliest period being shrouded in obscurity. Ancient Empire 4400 to 2466 B. C., Middle from 2466 to 1200, B. C. New Empire 1200 to 340 B. C.



Vase from "Vases Antiques," by B. Pecheux.

**T**HE lotus directly conventionalized is found in Egyptian ornament more frequently than any other plant. Bud, blossom, leaf and stem all do duty under various guises. It was sacred to the Egyptians and consequently displayed at every turn, both in connection with representations of the divinities and as accessory to architectural forms. Probably no plant in the history of mankind has ever had lavished on it the devoted study which has been spent upon the lotus. From it Prof. Goodyear in his "Grammar of the Lotus" traces the descent of many later patterns used in architecture and decoration, such as the an-



Designs founded on Feather and Lotus.



Egyptian Keys.

themion and egg and dart, etc. Besides the lotus patterns, the fan shaped feather designs signifying sovereignty, the zigzag, fret, whorl, wave, daisy, scale, star, and other units are found and the palm and papyrus are much in evidence, with the

winged globe symbolizing divinity.

Conventionalization in their ornament, as in all else that the Egyptians did, was the keynote of its perfection. Observe the architectonic character of their mural carvings, whatever the subject they treated, and of the form of the mummy case. Is there anything in conventional art more perfectly satisfying than the form of an Egyptian seal or cartouche, and the masterly representation of the scarabaeus in precious stone, which is a perfect beetle form, and yet is so conventionalized as to set up no childish rivalry with the actual. The poetry is there, the idea is given, eye and mind are delighted, and art can do no more.

Although the most that we know of Egyptian decoration is of the decadent period, yet its beauty is great both in form and color, applied with thorough appreciation of the



Meiamoun Ramses Vase,  
Showing Key of Divine Life.



Designs founded on the Lotus.

best results. In the darker parts of the temples one could hardly have seen color at all had it been put on in pale tints, therefore the Egyptian decorator laid on strong and glowing tones. Again, massive and heavy ornament was used where it would tell, and for parts of the building nearer the eye, more delicate forms and patterns were employed. If we could ever know the entire history of Egyptian ornament we should probably see that the little we now know is only as the glimmer of sunset to the full sunlight of its perfection.

The scale upon which Egyptian architecture and decoration repeated the forms of plants and trees in temples and other edifices, is reiterated in the arched nave of the Gothic cathedral with its clustered columnar supports.

By the use of flat tints, coloring everything without shade or shadow, a polychromatic scheme of decoration was developed, which as a logical system has never been excelled. From this and from the modeled ornament the Greek, Roman and Byzantine, and all contemporary and succeeding schools have imbibed as from a great fountain head.



Hawk and Cobra.





Column and Great Gate between the Gates of the Imperial and Forbidden Cities, Pekin, China.

From copyrighted photographs by permission of Underwood & Underwood, New York.



Chun-Ka-Taie, Ancestral Hall of the great Chun Family of Canton, China.

# Chinese.

Origin in the early art of different Mongolian tribes.



Antique Chinese Rug.

LL Chinese ornament expresses the virility of a strong race. It even shows the tendency of the Mongolian to agriculture and manufacturing rather than to letters and science. It is the work of people who are in a sense still primitive and robust, rather than civilized. Many examples indicate the simplicity of the savage in the ap-

parent effort to astonish, and a vein of barbarism runs through all, betrayed by crudity, heaviness and the use of strong and glowing color.

It is wonderful, nevertheless, to see what a deep knowledge of the mere motifs or units of design and of harmony in combination of colors the Chinese possess. The more one learns of their art the more he wishes to know. A man who lived for years in the interior of China once told me that in the silk industry alone few Europeans knew of the beauty of the fabrics which the natives made, which were used by the richer classes, and



Ancient Cloisonné  
Collection of M. Emil Galichon.



Antique Chinese Rug.

were seldom exported, although efforts were being made to induce the manufacturers to export.

In distinguishing between Chinese and Japanese work, look for a ponderous quality and ruder coloring in the former. Yet these qualities are not always evident and a careless student is often surprised by the beauty of pieces of Chinese pottery. China has been a mine of inspiration to many of the schools of ornament, and France and England in particular have experienced "periods" of Chinese influence in both prints and pottery. In France through the establishment of close commercial relations with China in the reign of Louis XV, Boucher, Huquet, and other designers became eager students of Chinese art, and even without revealing strong Chinese character their designs were affected by Chinese art as is shown in the massing of ornament and splendor of colors.

Critics do not seem to have been able to charge Chinese artists with overstepping the bounds of conventionality, however near realism comes much of their flower and fruit design.

Owen Jones, in his *Grammar of Ornament*, gives the Chinese credit for remarkable beauty of form in their pottery, but he also remarks that this is spoiled by the addition of built-up ornament, from which he argues that they possess only in a minor degree appreciation of form. They are how-



Ancient Chinese Bronze.



Ancient Chinese Bronze  
Candlestick.

ever wonderful colorists in the lighter tones of pure color. One cannot agree with him in saying that the Chinese are entirely unimaginative. It would, perhaps, be nearer the truth so say that our imaginations do not always follow theirs in their effort to suggest. It is a strange assumption that there can be no idealization in Chinese art if the Occidental mind does not perceive it,

The perfect carving with which the Chinese decorate wood, ivory, stone, etc., while exhibiting great skill, also frequently shows considerable imaginative power on the part of the designer. We see a foreground, middle

distance and distant hills in a flat carving of, say, a rice field with peasants at work, or the same variety in a view of a temple in a grove, and all done with only a quarter of an inch relief and often less.

It would not be strange if some day it were proved beyond question that early Celtic artists learned the secret of Cloisonne from the Chinese.

Western art has not yet learned all that the Chinese can teach.



Modeled Lacquer.



# Japanese.

Origin in Korean, Chinese and other Mongolian Art.



IT is of course impossible in such limited space to describe the various periods of Japanese art, and for the purposes of this article it is not necessary to give more than a general description of it.

Japanese and Chinese ornament have many noticeable points in common.

For example, the motive of the Greek fret or meander, which may or may not have its origin in the Swastika, and also rectangular outlines contracted with flowing rounded angles where sharp ones would be out of place, besides the use of the conventionalized plant forms and foliage are all familiar in both Chinese and Japanese work with an apparent kinship.



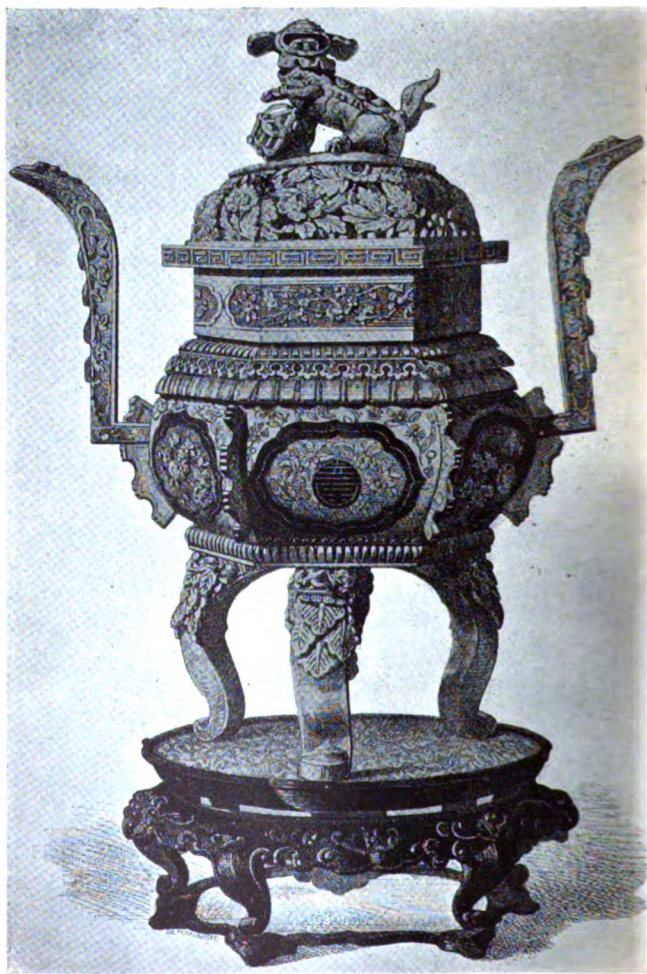

Ancient Incense Burner in Gilded Bronze.



Wooden Masque.

The perforated patterns in the metal and stone lanterns of the Japanese show frequent resort to the outlines of different fruit and flower blossoms, and geometric patterns are also introduced sometimes with and sometimes without the freer forms obtained directly from nature. Oriental

art indicates a marvelous intimacy with natural and geometrical forms, and the Chinese and Japanese seem sometimes to look at them with the same eyes.

Chinese ornament shows a sturdy and virile quality which is not so noticeable in Japanese, not that there it is entirely lacking,

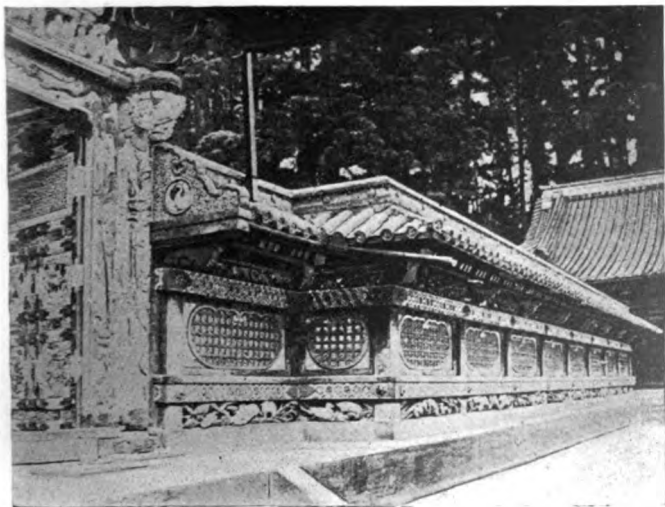

Paneled Terrace and Door of Karamon, Nikko.





Shiba at Tokio.



Holy Water Cistern.



Carved Panels, Tomb of Ilyasu, Nikko.

but because the more volatile mind of the Japanese seeks often to refine where the Chinese obtains an effect in a simpler and more direct way.



Howo Birds. Wood Carving, Ancient Temple Ramma. XIII Century.

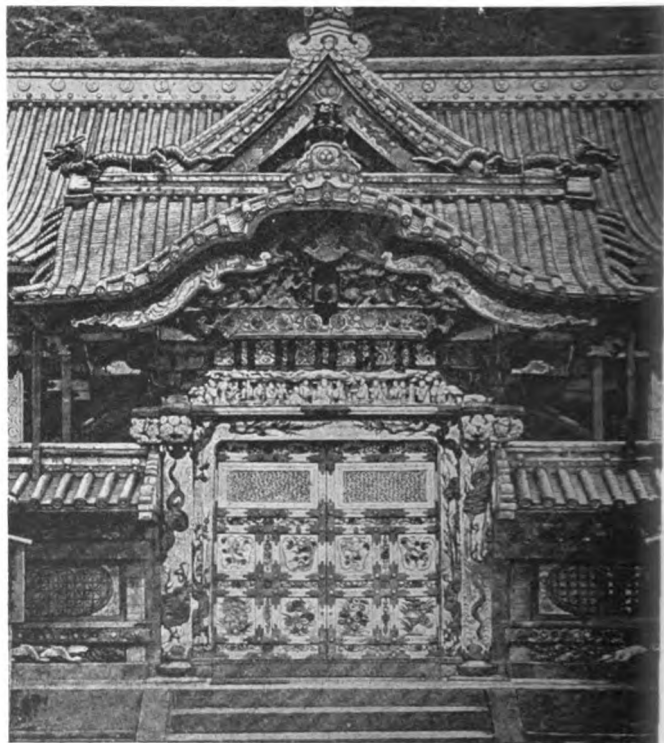

Door of Carved, Gilded and Lacquered Work, Temple at Nikko, XII Century.



Mountain Pheasant and Plum Blossom, by Kano Tanyu, 1720 A. D.



Decorative Disc of Stork.

In ornamental lacquers the Japanese have for centuries excelled, and it is possible that from these the idea of famous French lacquers and finishes was taken.

Perhaps the most interesting thing in Japanese art is the proximity of its conventionality to realism and yet its absolute separation from it. Of all the schools of ornament this one goes most repeatedly to nature for inspiration and yet rarely offends; even where bird, tree, fish, waterfall or sky is nearly, it is not quite copied. Just enough pose is given to all animal forms, just enough conventionality to all foliage or flower to tell at once that it was arranged by human hand, and hence





Temple Carving, XIII Century.

comes the great interest which we take in the design. Nature is improved upon constantly, so to speak, by the suggestion which she has given to the artist.



Old Palace Ramma. Satsuma  
Oak and Gold Lacquer,  
1550, A. D., by Hida  
Takumi.

Japanese ornament is full of imagination and idealization from all natural forms. In harmony of color the Chinese approach, and may at times equal, but do not excel the Japanese, while in beauty of form the Japanese are immeasurably superior. Take pottery for instance, the Japanese is full of meaning, while the Chinese is generally odd, made to surprise rather than to delight.



Carving at Nikko, by Kano Tanyu, 1720 A. D.

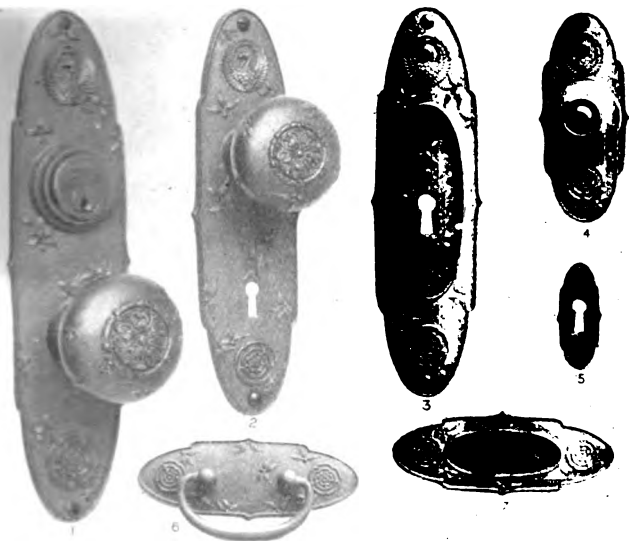

Yale & Towne Designs.

Japanese.

The Multipliers indicate the relative prices of the various finishes as compared with prices of corresponding pieces in the Cluny Design, Copper Finish, (CY22), pages 734 and 735. For Explanation of Multipliers see page 34. For Explanation of Finish Symbols see page 609.

(OSAKA)—Figs. 1 to 7 above, . . . . . 11 pieces, including

Esc'n Plates and Knobs, p. 315  
 Cup Escutcheons, . . . " 906  
 Flush Sash Lifts, . . . " 916\*

Push Buttons, . p. 897  
 Cabinet Trim, . " 972A

Appropriate Finishes: Copper (CY22) Mult'r 3.; Royal Copper (CY25) Mult'r 10.; Sage Green (BY70) Relief Gold, Mult'r 12.6; Gun Metal Brown (BY62) Relief Silver, Mult'r 9.7; Gold (GY10) Mult'r 12.6

\* A few Designs only are shown as examples.

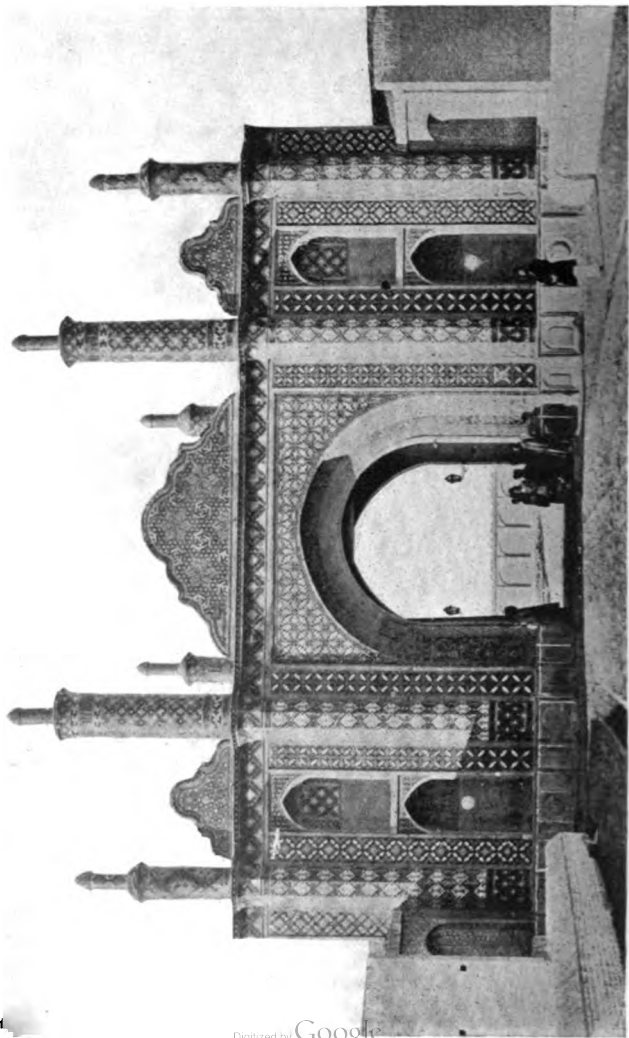

City Portal, Teheran, Persia.

## Persian.

Conquest of Persia by Abu Bekr, 632-637 A. D. Highest development under Shah Abbas, 1586-1625.



Persian Dish.

**A**NCIENT Persian ornament is almost identical in character with Assyrian. In them both we find the lotus still used in a manner so suggestive of Egyptian decoration as to indicate the latter as the origin of Assyrian art. The symbolic tree of the Assyrians is familiar to all and is an idea in design which has descended

through oriental art down to the present day, as Mr. Lewis F. Day so interestingly explains in his "Nature in Ornament."

Discs of bold patterns which we see later in Sassanian Persian work, and even modified in form in the Renaissance of Italy, France and Spain, are most boldly and effectively handled in Assyrian. The daisy or kindred flower is evidently an inspiration for many of these discs unless Mr. Goodyear will throw these also to the insatiate lotus cult and make them up of radiating buds. Checker, flute, diamond, scale, and many of the old primitive and prehistoric units abound, and the foliage of the acanthus is carved in a massive and imposing fashion. The guilloche and chevron also are seen.

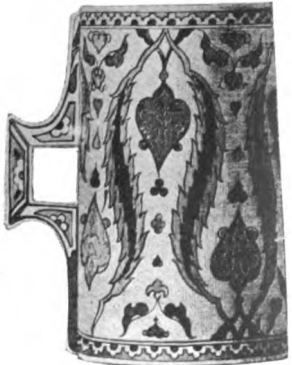

Ceramic Mug.

Later Persian is a mixed but





Faience Mug.

beautiful school, more of a feminine and luxurious character, but yet it is the school of a sybarite who loves his garden, his roses, his song birds and his music, all which brought poetry and happiness in the daily struggle and made the wolf awhile outside the wall. With Indian and Arabian art the Persian was much involved, and to-day shows how vigorous was the Persian stock that once swept the East before it, not only in battle, but in the arts also. To-day he is fortunate who owns a really good specimen of art

of the best Persian period.

Animal life was introduced into Persian art, which distinguishes it from that of the Arabians and Moors, as also does the combined use of conventional and natural forms, as we have seen in the Chinese. Like the latter the Persians lived close to the garden and the field, and reproduced the very air thereof.

In the illuminating of manuscripts the Persians found a rapid vehicle for the dissemination of their style, while through the channels of trade their stuffs and other manufactures found a ready market, so pleasing was the displayed in carpet,



Metal Ewer.



**Faience Plates—Lindos, Island of Rhodes.**



**Ceramic Pitcher.**

rug, silk, carving and metal work of all kinds.

Flowers are the Persian's favorite theme, a safe source of inspiration for poet or designer in all ages and nations, and the rose shares with the carnation the honors of his printed page, his silken rug or his marble lattice. In distinction from the Egyptian, the lotus is at length deposed and the flora of dry land are the court favorites.



**Faience Ware—Lindos, Island of Rhodes.**

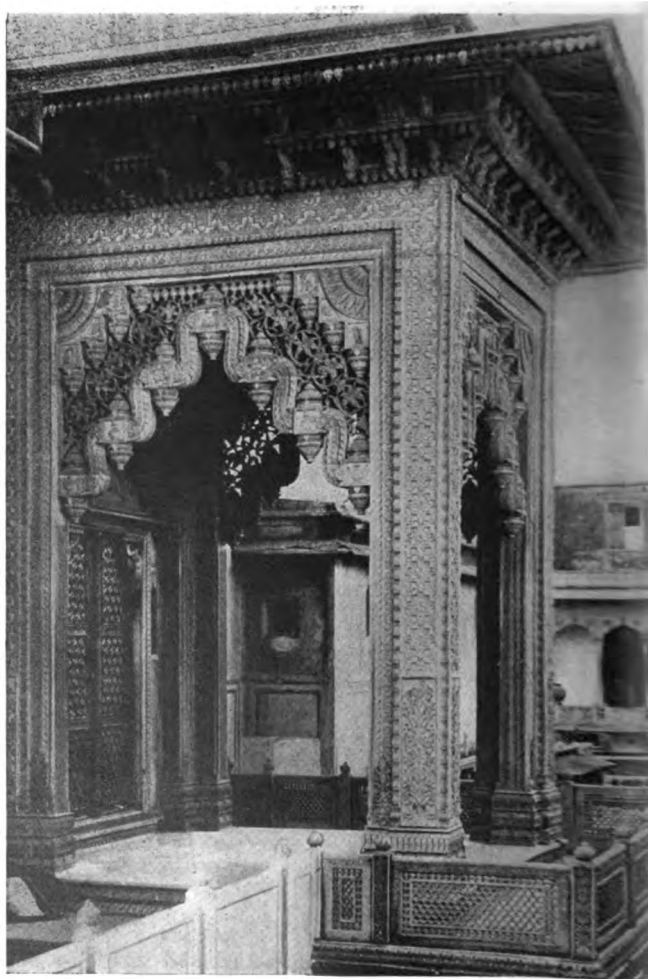

**Jain Temple at Delhi, India.**

## Indian.

Buddhist religion, art and architecture introduced by Prophet Sakya Muni, B. C. 638, Jaina style 250 A. D., Conquest by Alexander the Great, 327 B. C., introducing Persian Art. Arabian Invasion, 711 A. D., Mahometan dynasty, 711-1152 A. D., Mogul dynasty, 1525-1837 A. D.



Jeypore Brass Tray.

PERSIAN influence and also a vague likeness to Chinese forms, are distinctly seen in Indian ornament. Fruit and flower suggestions are freely used, and conventionality strictly observed. A wonderful richness and refinement of leaf and stem in geometrical patterns and also free and flowing designs are common.

It is in such buildings as the Taj Mahal and in many of the private house balconies and doorways that the beauties of Indian work are especially noticeable. The pierced stone and wood and metal work found all over India are unsurpassed examples of a high degree of art, and show the wonderful possibilities in the conventional treatment of natural forms; Indian grilles in marble often reach such heights of grace and beauty that it seems as if human imagination could not go beyond them.

The paneling of woodwork enriched by ornamented bosses of metal or wood at the intersections, often suggest the bold studded effects on Byzantine caskets, and doubtless Byzantium borrowed much from many Eastern schools.

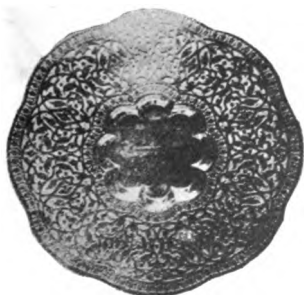

Jeypore Brass Tray.



Details at Ahmedabad.

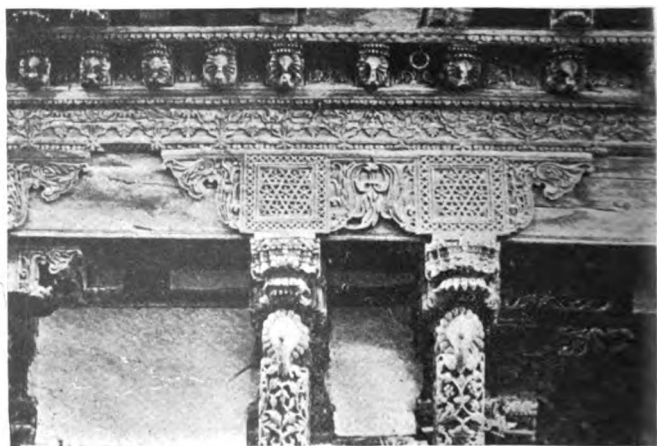

Details at Ahmedabad.

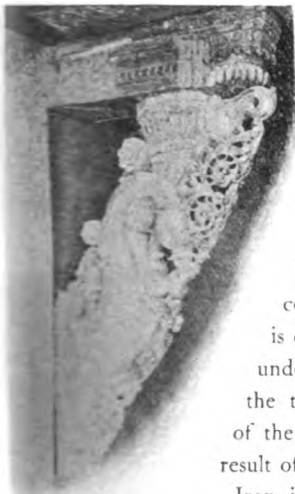

The excessive richness of Indian ornament is at times almost labored and cloying, but the impression given is that of a tireless art which never ceases reproducing pattern after pattern, each more wonderful than the last, and all in harmony. In fact this harmonic chord is the dominant and constantly repeated undertone, which is charming, although we cannot quite understand how it is produced. It is like the trick of the fakir, the soporific tune of the snake-charmer, but nevertheless the result of great knowledge of ornament.

Iron in India is most delicately wrought into railings and grilles, while brass, bronze and copper are, as all the world knows, most appropriately decorated according to the characteristics of the metal. In wrought iron is found many a design used later in European work, the scroll or volute being frequently introduced. One very noticeable fact about Indian ornament of to-day is that it shows less tendency to deteriorate by catering to the European market, while Japan and other countries are showing the bad effects of this commercial spirit of copying things English and American.



Window, Shapoor Mosque.



Rani Sipri Mosque.



Meerjapoor Mosque.



Rani Sipri Mosque.



Meerjapoor Mosque.



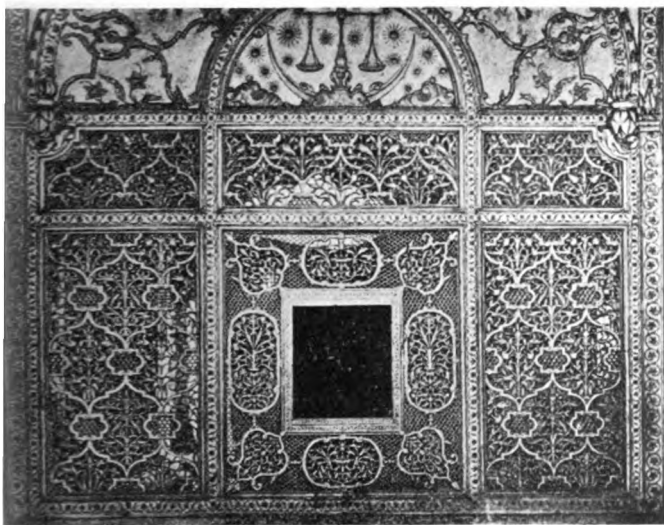

Pierced Screen, Throne Room at Delhi.

It one were asked to state in which direction Indian ornament was most emphatically effective, it would be safe to say that it was in the use of perforated designs. The great beauty obtainable by piercing the material used was early appreciated and carried to such remarkable results, that in this kind of work no school has excelled, and few have equalled the examples found all over India. It may be that in Persian art lie the beginnings of this vein, yet perhaps it is safer to say that each Oriental school has in greater or less degree intuitively felt the value of perforated work, but that India has carried it to wonderful heights.

No one realizes better than the writer the utter inadequacy of a brief description of Indian decoration. It is a subject on which volumes have been written, and yet all has not been said.



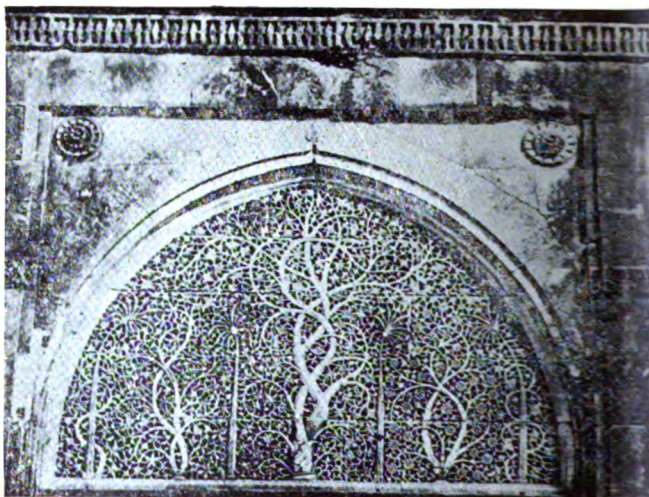

Bhudder Window at Ahmedabad.

One fact, however, strikes the student forcibly, and that is that natural forms are not made too realistic nor are they violated but interpreted by the eye and hand of close and fond observers.

To Mr. Lockwood de Forest I wish to acknowledge my indebtedness for the loan of most of these illustrations. They are from the photographs taken by order of the English government

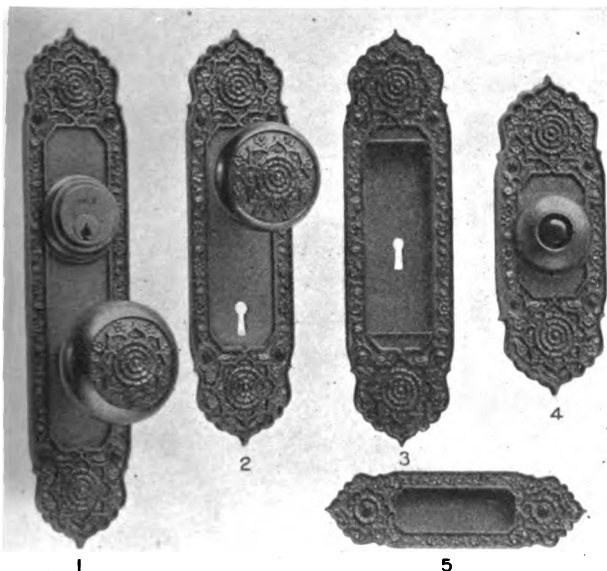

Yale & Towne Designs.

Indian.

The Multipliers indicate the relative prices of the various Finishes, as compared with prices of corresponding pieces in the Cluny Design, Copper Finish (CX22), pages 734 and 735. For Explanation of Multipliers see page 34.

For Explanation of Finish Symbols see page 609.

MANDALAY—Figs. 1 to 5, above, . . . 21 pieces, including

Esc'n Plates & Knobs, p. 327	Flush Sash Lifts, Fig. 13 p. 916
Cup Escutcheons, . . . " 905	Push Buttons, . . . " 896

Appropriate Finishes: Copper (CY22) Mult'r 2.2; Brass (AY22) Mult'r 2.2; Statuary Bronze (BY65) Mult'r 2.2; Silver (SY52) Mult'r 2.75, (SY55) Mult'r 3.5; Gold (GY10) Mult'r 9.6

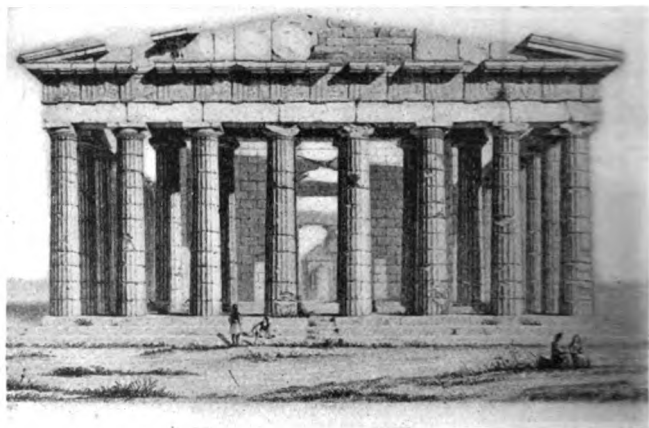

**The Parthenon.**

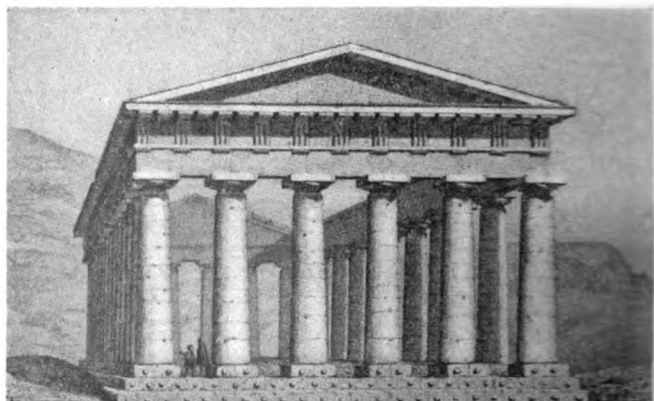

## Greek.

Pericles, 470-49 B. C. Ictinus, Callicrates and Phidias on Parthenon  
454-438, B. C. Scopas, 430 B. C. Bryaxis, 372 B. C.

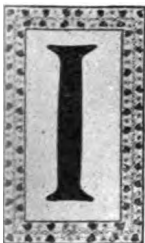

IN the best period of Greek ornament the characteristics are reserve, dignity and beauty of form and outline.

Professor Goodyear, in his Grammar of the lotus, has certainly made a strong argument for the origin of many of the Greek forms, in the lotus, which is itself one of the beautiful and inspiring flowers to a designer. The egg and dart developed in Mr. Owen Jones' and Professor Goodyear's illustrations from the reversal of lotus patterns, the meander, (which we know is common to the art of many people, even to the Aztecs and prehistoric people of the American Pueblos) the anthemion of the honeysuckle and palm, bay, laurel, ivy, etc., were all used by the Greeks, and are found in the greatest variety on their vases and architecture. This period of Greek art was the result of the eclecticism through centuries of a wonderfully gifted people, aided by the environment of beautiful



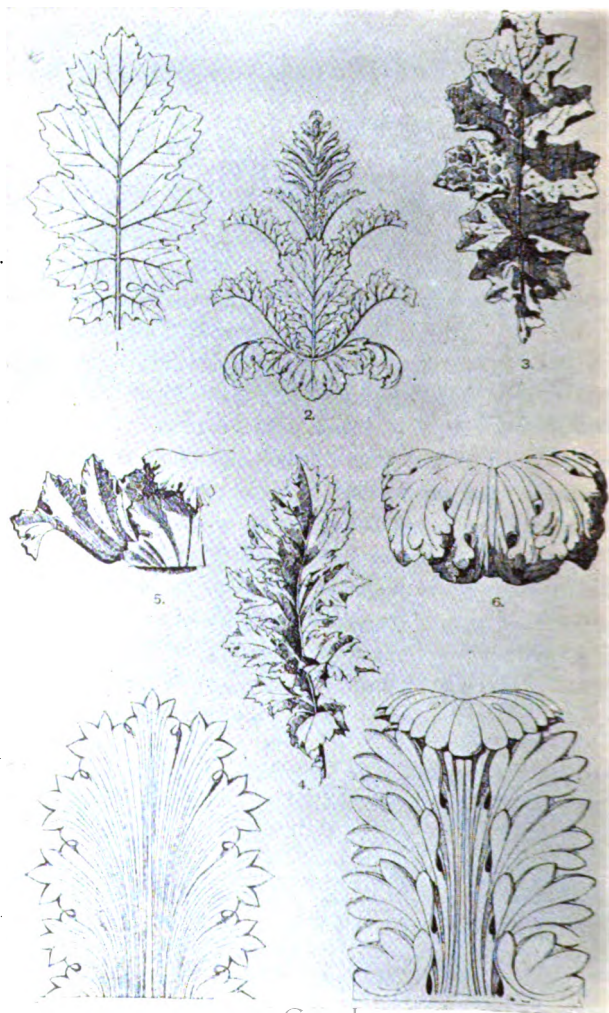



Finial from the Monument  
of Lysicrates, Athens.

ornamental art was in the caves of Western Europe, where man of the paleolithic age first began to long for something beyond the practical utensils of life and ornamented his dagger and harpoon with flint point etchings. This cannot be disputed and Greece was only giving back in a developed form through Italy and the Renaissance that which she had long borrowed through the migrations of unknown tribes.

Greek ornament above all teaches the value of restraint and convention-



Anthemion.

landscape and temperate climate, so that though it is to the Greeks we owe most of our present civilization and its attendant advantages, they themselves were indebted to earlier races of some of whom perhaps they had heard little and knew less.

It is said now, and with strong show of reason, that the beginning of



Anthemion.

ality, and yet when one has seen all that can easily be seen, the marvelous variety of design and the freedom from absolute stiffness and hardness is especially instructive. In their cast metal work we find the same beauty of form as in their pottery and carvings. Iron for ornamental forms was evidently not highly valued, for although its con-



Painted Vase.

structive use is proven in the stone buildings at Assos and elsewhere, its malleable qualities do not seem to have been decoratively employed, by the Greeks. The refinement of outline, the entasis of column and cornice, the value of pure color, and above all the appreciation of the contrast between plain and ornamental surfaces are strong characteristics of Greek work. These are not exclusively Greek, but, although preceding art indicated a knowledge of the value of

all these attributes, in Greek art they were most highly developed.

To the Greeks we owe the development of the use of color on architecture, a refinement of its use by the Egyptians and



Acanthion Moulding, Erectheum.



Fret or Meander.

earlier races, and especially are we indebted to them for the last stages of a most perfect system of conventionalization of forms from nature. I say the last stages because there is no question but that antecedent races began what the Greeks finished. The

Repeated Egg and Tongue  
on an Ovolo.

Swastika is the most ancient proof that conventionalization began with the first steps away from man's primitive state. The Greeks were heirs to all that came after, but heirs who so improved their inheritance as to leave little chance for future improvement along the same lines. The world of design has not yet found a leaf more adaptable to general architectural ornament than the acanthus, and it is still used in the Greek forms.

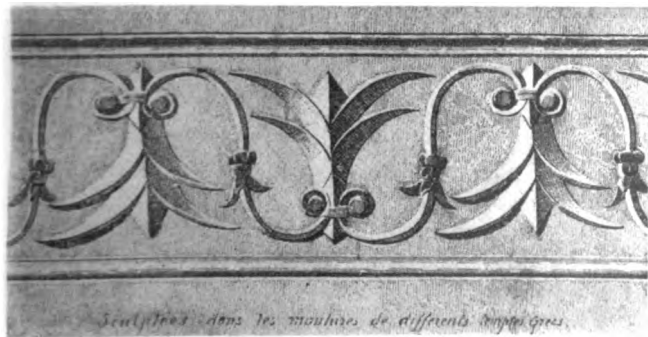
*Sculptées dans les moulures de différents temples grecs.*





1



2



3



4



5



6



7



8



9



10



11



12



13

## Yale &amp; Towne Designs. . . . . Greek.

The Multipliers indicate the relative prices of the various Designs and Finishes as compared with prices of corresponding pieces in the Cluny Design, Copper Finish (CX22), pages 734 and 735. For Explanation of Multipliers see page 34.

For Explanation of Finish Symbols see page 601.

ARCHALA—Fig. 42, page 860, . . . . . Hinge Plate only.

ARGOS—Fig. 1, page 334, . . . . . 19 pieces, including

Esc'n Plates and Knobs, p. 334	Push Plates, . . p. 923*
Cup Escutcheons, . . . " 904	Door Pulls, . . . " 823
Flush Sash Lifts, . . . " 916*	Cabinet Trim, . . " 964
Push Buttons, . . . . " 895	

Appropriate Finishes: Brass (AZ15) Mult'r 1.7; Copper (CX22) Mult'r 1.7; Silver (SX52) Mult'r 2.25; Iron (FX80) Mult'r .95

ARTA—Fig. 8, page 957, . . . . . Key Plate only.

ATHENS—Figs. 4 and 6, page 594A, . . . . . 18 pieces, including

Esc'n Plates and Knobs, p. 594A	Drawer Pulls, . . p. 925
Cup Escutcheons, . . . " 904	Push Buttons, . . . " †
Flush Sash Lifts, . . . " 916*	Push Plates, . . . " 923*

Appropriate Finishes: Copper (CY22) Mult'r 1.7; Silver (SY52) Mult'r 2.1; Gold (GY10) Mult'r 8.3; Iron (FX80) Mult'r 1.

CASALE—Fig. 9, page 878, . . . . . Lever Handle only.

CORINTH—Figs. 2 and 6, page 334, . . . . . 45 pieces, including

Esc'n Plates and Knobs, p. 334	Drawer Pulls, . . p. 926
Cup Escutcheons, . . . " 905	Door Pulls, . . . " 824
Flush Sash Lifts, . . . " 916*	Push Buttons, . . . " 895
Cylinder Faces, . . . . " 924	Shutter Knobs, . . " 940

Appropriate Finishes: Brass (AX22) Mult'r 1.4; Copper (CX22) Mult'r 1.4; Bronze (BX67) Mult'r 1.9

CYDONIA—Figs. 15 and 19, page 857, . . . . . Hinge Plates only.

DODONA—Fig. 3, page 334, . . . . . 58 pieces, including

Esc'n Plates and Knobs, p. 334	Push Buttons, . . p. 896
Store Door Handles, . . . " 749	Door Pulls, . . . " 825
Cup Escutcheons, . . . " 905	Push Plates, . . . " 923*
Flush Sash Lifts, . . . " 916*	Shutter Knobs, . . " 940
Drawer Pulls, . . . . " 926	

Appropriate Finishes: Copper (CX22) Mult'r 2.; Silver (SX52) Mult'r 2.7; Bronze (BX67) Mult'r 2.7

\* A few Designs only are shown as examples. † Not illustrated.

## EPHESUS—Fig. 4, page 334, . 55 pieces, including

Esc'n Plates and Knobs, p. 334	Door Pulls, . . p. 825
Store Door Handles, . " 749	Push Plates, . " 923*
Cup Escutcheons, . . " 905	Shutter Trim,
Flush Sash Lifts, . . " 916*	Figs. 9 & 12, " 922
Extension Bolt, . . . " 894*	Cabinet Trim, . " 967
Push Buttons, . . . " 896	

Appropriate Finishes: Brass (AY22) Mult'r 1.7; Copper (CX22) Mult'r 1.7; Bronze (BX67) Mult'r 2.3; Gold (GX10) Mult'r 9.6; Iron (FX80) Mult'r 1.

## GARDO—Fig. 5, page 334, . 39 pieces, including

Esc'n Plates and Knobs, p. 334	Hinge Straps, . p. 851
Store Door Handles, . " 751	Door Pulls, . . " 825
Cup Escutcheons, . . " 905	Push Buttons, . " 896
Flush Sash Lifts, . . " 916*	Push Plates, . " 923*
Hook Sash Lifts, . . " †	Cabinet Trim, . " 968
Letter Drop Plates, . . " 917*	

Appropriate Finishes: Bronze (BZ10) Mult'r .7; Copper (CX22) Mult'r .7; Silver (SY52) Mult'r 1.25

## LARISSA—Fig. 10, page 334, . 72 pieces, including

Esc'n Plates and Knobs, p. 334	Push Buttons, . p. 896
Store Door Handles, . " 751	Push Plates, . " 923*
Cup Escutcheons, . . " 905	Door Pulls, . . " 826
Flush Sash Lifts, . . " 916*	Shutter Knobs, . " 941
Bar Sash Lifts, . . . " †	Cabinet Trim, . " 970

Appropriate Finishes: Bronze (BZ10) Mult'r .85; Copper (CY22) Mult'r .9; Silver (SY52) Mult'r 1.4; Iron (FX80) Mult'r .55

## MARATHON—Fig. 11, page 334, . 76 pieces, including

Esc'n Plates and Knobs, p. 334	Extension Bolts, p. 894*
Store Door Handles, . " 759	Push Buttons, . p. 896
Cup Escutcheons, . . " 905	Push Plates, . " 923*
Flash Sash Lifts, . . " 916*	Door Pulls, . . " 826
Letter Drop Plates, Figs.	Shutter Knobs, . " 941
7 and 8, . . . . " 917	Cabinet Trim, . " 972

Appropriate Finishes: Bronze (BZ10) Mult'r .95; Copper (CZ17) Mult'r 1.; Silver (SY52) Mult'r 1.5; Iron (FX80) Mult'r .6

\*A few Designs only are shown as examples. †Not illustrated.

**MILETUS**—Fig. 13, page 334, . 49 pieces, including  
 Esc'n Plates and Knobs, p. 334 Flush Sash Lifts, p. 916\*  
 Store Door Handles, . " 753 Door Pulls, . . " 827  
 Letter Drop Plates and Push Buttons, . " 896  
 Hoods, Figs. 11 & 12 " 917 Push Plates, . " 923\*  
 Cup Escutcheons, . . " 906 Shutter Knobs, . " 941  
 Appropriate Finishes: Brass (AY22) Mult'r 2.1; Copper (CX22)  
 Mult'r 2.1; Bronze (BX67) Mult'r 2.8; Iron (FX80) Mult'r 1.25

**RHODES**—Figs. 7, 8, 9 and 12, page 334, 19 pieces, including  
 Esc'n Plates and Knobs, p. 334 Cup Escutcheons, p. 906  
 Store Door Handles, . " 755 Flush Sash Lifts, " 917\*  
 Letter Drop Plates and Bar Sash Lifts, . " †  
 Hoods, . . . . " 917\* Drawer Pulls, . " 928  
 Butts, Fig. 10, . . . " 919 Push Buttons, . " 897  
 Appropriate Finishes: Copper (CY22) Mult'r 1.4; Silver (SY52)  
 Mult'r 2.1; Iron (FX80) Mult'r .95

\* A few Designs only are shown as examples. \* Not illustrated.

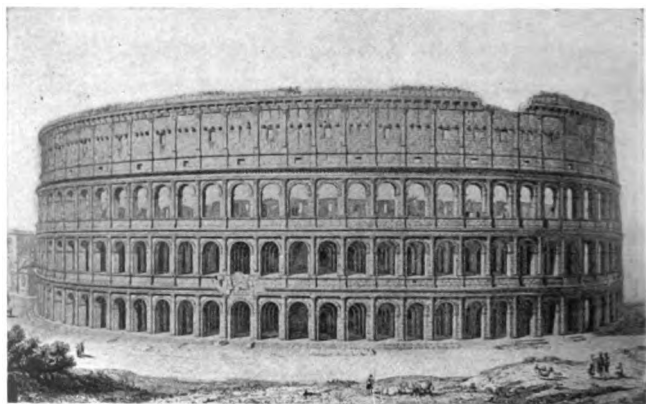

**Elevation Flavian Amphitheatre, Colosseum at Rome.**

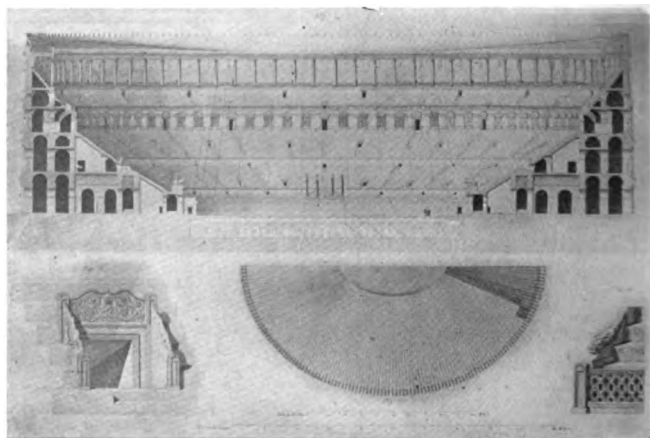

**Section Flavian Amphitheatre, Colosseum at Rome.**

## Roman.

Rome founded 783 B. C. Absorption of Etruscan art 567 B. C., of Samnite art 340 B. C., of Corinthian and Carthaginian art 146 B. C. (Historic Ornament, Richard Glazier, Batsford, London), Vitruvius Pollio, 1st Century A. D., Apollodorus 100 A. D.



White Marble Urn,  
Vatican Museum.

**G**REEK artists and artisans working under Roman control produced what was best, and also much that was bad in Roman art. Rome, rich past all precedent, could buy what she could not herself produce, and with the barbaric idea of excelling all that the world had

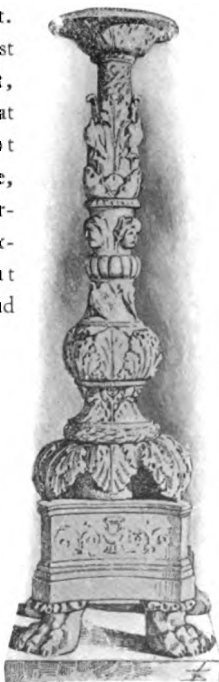

Antique Marble Candelabrum.

previously known of splendor in architecture and ornament, her successive Emperors long employed Greek artists, until her own great architects and builders arose. The logical result of this was a style based upon the Greek orders concurrently with which was developed ornament founded largely upon the acanthus, with frequent use in encarpa or festoons of garlands of fruit and foliage, animal forms and mystic symbols. Thus on Roman altars we see the most charming



**Roman Doorway at Baalbec.**



Byzantine Altar.

carvings of flowers entwined with the product of field and vineyard in rich and heavy festoons emphasized at the corners, or at more frequent intervals, with rams' heads and bucrania. Panels filled with spiral patterns of acanthus, relieved by conventional rosettes, griffins, fauns, and satyrs are executed with such skill and in such profusion that one is amazed both by the richness and the careful execution of the detail.

The acanthus was particularly developed in arabesques, while panels of all kinds of plants, both freely and conventionally treated, were often used, so that it is easy to see that both Byzantine and Renaissance artists found in Roman art inspiration of the most direct sort. In fact it is difficult to distinguish many of the pilaster panels of the early Renaissance from the Roman, and the regularity and repetition of the acanthus points, so common in Byzantine work, is seen in the more conventional Roman designs whence it passed to Byzantium and thence back again into Early Christian and Romanesque forms in Northern Italy and France. Take for instance the leaf forms on the pedestal in the Villa Albani printed in Statham's "Ancient Architectural Ornament:" the design might have been executed during the early part of the Byzantine period in Ravenna.

If one would see upon what skill, and knowledge of the value of line and form, Rome could count in the multitude of designers and artisans at her command, it will well repay the trouble to look at the plaster casts of sketches of flying



Marble Base of Candelabrum.





Silver Bowl.  
Hildesheim Treasure.

figures for mural decoration in low relief, at the Metropolitan Museum, New York City, where also many good examples of Roman architectural ornament are reproduced. . Decoration in stucco for private houses and public buildings, tombs, etc., was most effectively done both as regards design and execution, and although probably the result of the training of foreign masters, if not actually the work of their hands, its beauties are none the less charming and instructive, and must be classed as Roman. If the workers in stucco could draw as these flying figures and much of the work in the houses and tombs would indicate, it shows that art was deep-rooted, for here was one of the commonest materials, wet plaster, and yet the work done in it is such as would not make later masters blush, were they able to express so much in so few lines and in such small space.

The Vatican Museum is full of beautifully decorated vases and other carved marbles of which Statham's book gives exquisite etched reproductions, but these should be supplemented by photographs to show the delicate lights and shadows which accompany good modeling.

The treasures found at Hildesheim, Germany, consisting of the silver camp utensils of a Roman General, give some idea by the beauty of their outlines and decoration, of what Roman silver-smiths produced in the way of design. The qualities of the material are most carefully observed and every advantage taken to



Silver Wine Cooler.  
Hildesheim Treasure.



Red-glazed Roman Bowl.  
From a London Excavation.

The festoon is most common in Roman ornament and is made up of fruits, flowers, cereals, etc., and used both on funeral and festal occasions, so that it is carved on tombs and also on architectural facades both civil and domestic to an extent which taxed the ingenuity of the Roman designers.

The origin of the festoon in architecture must be sought almost as far back as the first use of flowers as an outward expression by man of those emotions which could not be fully expressed by song or lamentation: certainly even to-day it is remarkable what force and significance are obtained by the use of the varied forms of the festoon.

Almost its direct opposite is the fret, key or meander, in whose stateliness and formality little is expressed either of pain or pleasure, whence we find it most properly employed as a

bring them out, and show that brilliancy, lustre, ductility, malleability and all the resources of casting may be utilized, where desired, in working in silver. The Corcoran Gallery in Washington has electroplate reproductions of some of this treasure.



White Marble Vase.  
Vatican Museum.



Temple of Vesta.

Roman art after the Byzantine epoch was the Romanesque school which embraced not only the Roman in crude forms, but also the Byzantine and eastern schools especially in Southern France.

border or margin decoration to offset the livelier character of other motifs.

The origin of this we have already traced to the Swastika, and in one form or another find it in all countries and schools.

Of course the anthemion is in frequent evidence introduced by Greek artists and in varied forms.

The immediate successor to

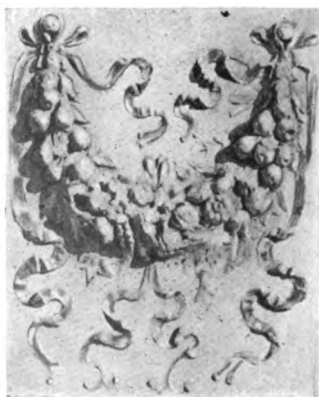

Encarpus or Festoon.  
Vatican Museum.

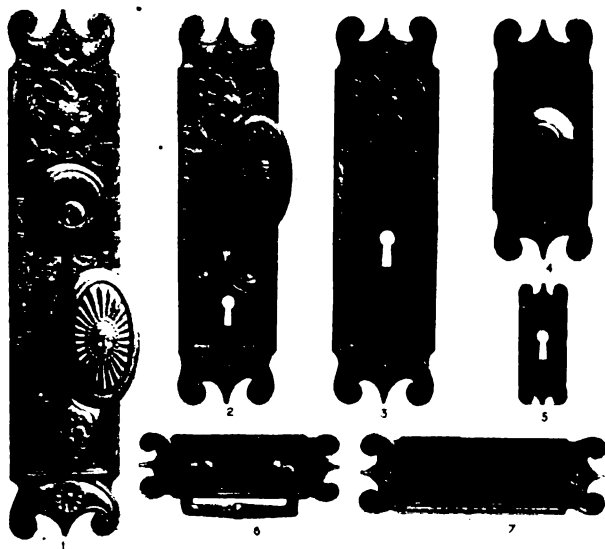

Yale & Towne Designs.

Roman.

*The Multipliers indicate the relative prices of the various Finishes, as compared with prices of corresponding pieces in the Cluny Design, Copper Finish (C.Y22), pages 734 and 735. For Explanation of Multipliers see page 34.*

*For Explanation of Finish Symbols see page 609.*

TIBER—Figs. 1 to 7, above,

- Esc'n Plates & Knobs, p. 345
- Cup Escutcheons, . . . " 906
- Flush Sash Lifts, . . . " 916\*

11 pieces, including

- Push Buttons, . . . p. 897
- Cabinet Trim, . . . " 972c

Appropriate Finishes: Copper (CY22) Mult'r 2.2; Silver (SY52) Mult'r 2.75, (SY55) Mult'r 3.5; Gold (GY10) Mult'r 9.6; Iron (FX80) Mult'r 1.6

\*A few Designs only are shown as examples.

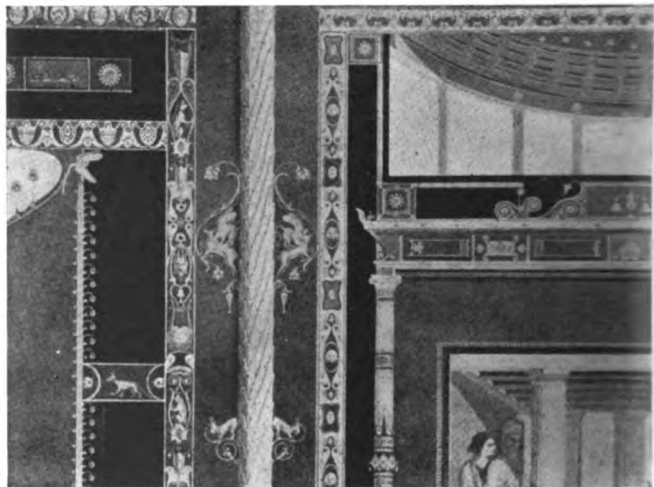

From House of Jucundus, Pompeii.



From House at Herculaneum.

# Pompeiiian.

Pompeii, Herculaneum and Stabia destroyed 79 A. D. Herculaneum re-discovered 1709, Pompeii 1748.



Scenic Masque in Marble.

**T**AKING its rise in Greek and Roman art or from the same sources, Pompeiiian ornament shows its origin at every turn. Done for the delight of an æsthetic, pleasure-loving people, their characteristics are clearly imprinted on frescoes, mosaics, household utensils and architecture. Light, full of grace and beautiful color, it

is not strange that similar art has attracted even the greatest masters. Raphael's frescoes in the Loggia of the Vatican, and other works of the Renaissance seem full of the spirit of the Pompeiiian artists, and we know that a similar vein in Roman remains, namely in the House of Livia and in the Baths of Titus and elsewhere, inspired them. Certainly the Renaissance began almost where Pompeiiian art ended. No art was ever developed wherein so little was made to do service for such great effects. A blank wall annoyed, and it was changed into a most graphic battlefield, or, was the houseowner of a more



Glass Vase,  
Blue and White.

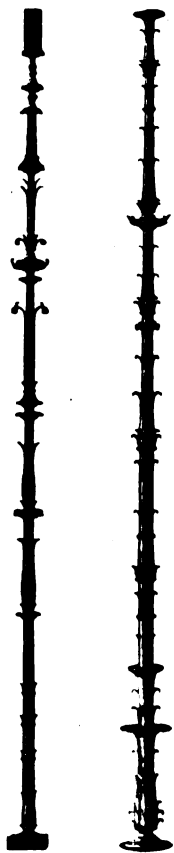

From Frescoes.

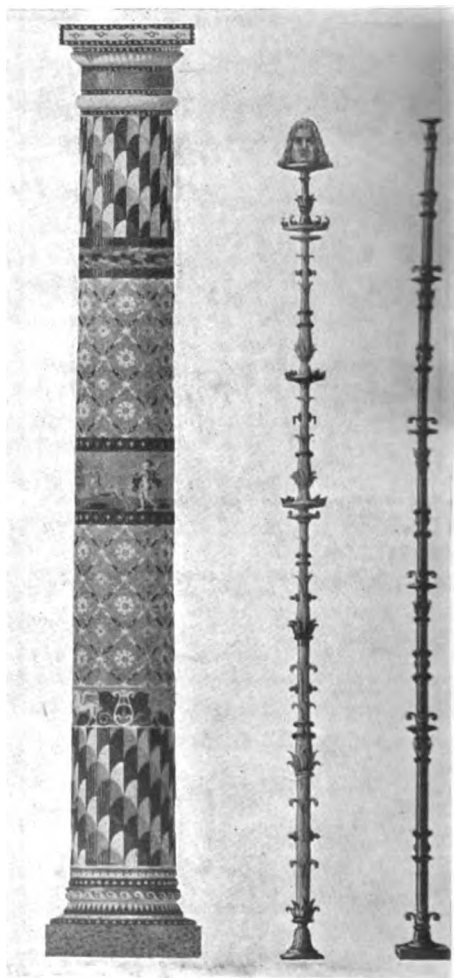
Mosaic Column,  
House in the Street of Tombs.

From Frescoes.



Bronze Tripod, Temple of Isis.

bucolic temperament, the loves of heroes and nymphs were depicted with wonderful skill. Theatrical often and scenic always, the mural art of Pompeii is to-day influencing French art, and through this the world. One of the most characteristic and interesting phases of this mural work is the representation of perspective effects in architectural forms, that are always light and graceful, and bring dimly to the mind's eye some Oriental suggestion, as music fills the imaginative with incomprehensible yet delightful inspirations. Slender and finely proportioned columns, or rather colonettes, with cherubs and graceful peri-like figures are often depicted on a flat field of beautiful color, bower-like structures suited to the birds, and children flitting through them, all deeply imbued with that spirit which open-air life breathes into any people. The sunlight is captive in the Pompeian frescoes, and all this wonderful skill subservient to fertile imaginations was at the service of even a comparatively humble clientage, as is seen by the fact that the most common utensils were not beneath the notice of a Pompeian designer.

In the frescoes, as in Egyptian, strong and glowing colors were used where few were necessary. Where many were employed and certain of them would otherwise seem out of harmony, pale tints were often put on. In brief, although in some cases the combinations are not pleasing to the modern eye, generally both designs and color effects are delightful.





Arabesques in Fresco. From the Naples Museum.



Lamps.

In all the arts that imperial Rome employed the lesser cities followed her, but Pompeii could not have been far behind if we compare known examples of the respective arts and crafts, and in some directions Pompeii had little to learn from Roman masters.

Indeed, as we examine the charming bronzes, mosaics and marbles in the Naples Museum, comparing them with what is to be seen in collections of Roman remains, there is a strong individuality about the Pompeiian that stamps it as a school apart, a style in which a sense of delicacy and the proportion of part to part is well studied and apparently done with an inherent knowledge of what is beautiful.

Out of the mass of Pompeiian art treasures the anatomical modeling of human and animal forms in statuettes and supports



Tripod Brazier.

and Roman stock resulted in the art-loving, pleasure-seeking and cultivated temperament of the man of the buried city.

Since the fearful events at Martinique and St. Vincent, the fate of Pompeii comes forcibly to mind, but no such art treasures will reward the excavator of the future at St. Pierre. It was a cataclysm of fearful nature which destroyed

of lamp, table, etc., stands conspicuous for its great beauty and for the revelation which it makes to the modern eye, of the old Greek sense of harmony of line, to which we feel Pompeii fell heir; not entirely through the influence of Greek artists who were imported by Rome, but through the Greek blood which flowed in the veins of so many of the inhabitants of Southern Italy. This, mingled with Etruscan



Marble Vase. Naples Museum.

each city, but a fortunate thing for art that, at Pompeii the less violent character of the eruption preserved perfectly so much that gives us instruction and delight in these days.

With these remains from the Italian city and our immediate knowledge of the destruction of St. Pierre we can look now on the man of Pompeii less as an ancient and more as a modern artist, for after all their wants, joys and sorrows and their consequent daily lives must have run much in the same channels except for art, and the last disaster brings Pompeii nearer.



**Marble Table Support,  
House of Cornelius Rufus.**

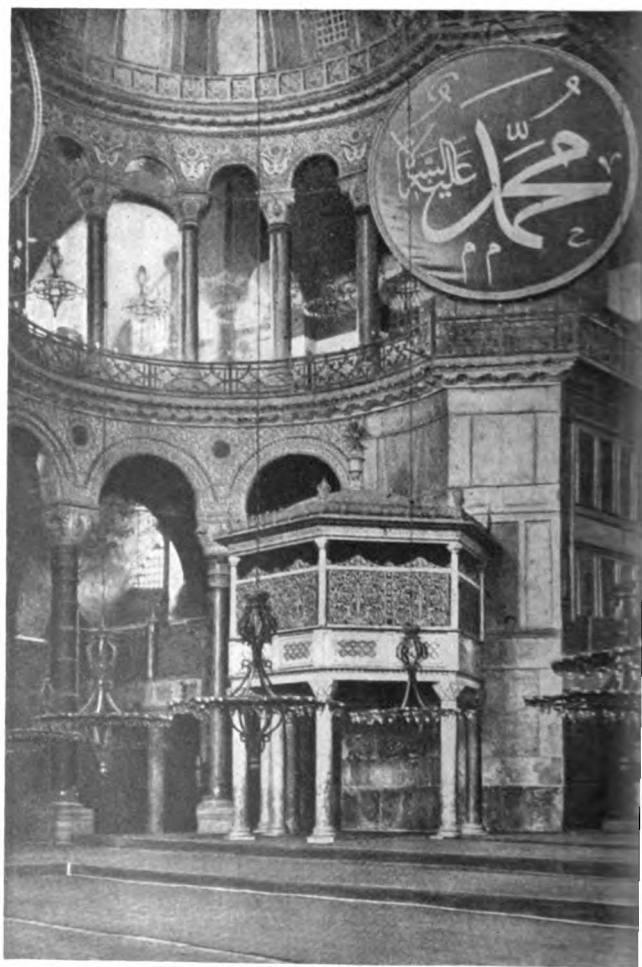

Interior, Aya Sofia (Santa Sophia), Constantinople.

## Byzantine.

330 A. D., 1453 A. D.    Fall of Constantinople.



**B**EFORE the seat of government was changed from Rome to Constantinople in 395 A. D., Byzantine art had already been born, but after this change great luxury and magnificence became the order of the day, and the arts of ancient Rome were mingled with the eastern and classic schools. This resulted in a hybrid but splendid style of design to which the name of Byzantine, Byzantium being the ancient city, properly attached itself. The influence of this Byzantine art was felt all over Europe, and especially in Russia, Italy, Germany and France. Hence we find in the Romanesque and the

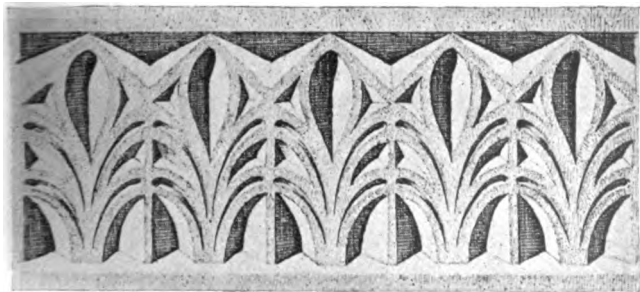

Ancient Fragment of Frieze, found at Toledo, Spain.



Manuscript Cover. Yellow, White, Blue and Green Enamels.



Carvings, Santa Sophia, Constantinople.

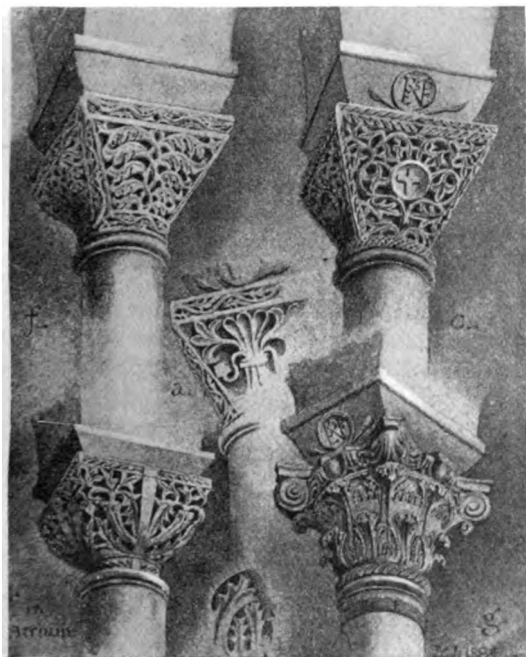

Capitals at Parenzo, Istria.

Renaissance work many traces of the Byzantine school. The crescent moon was originally a Byzantine emblem, afterward adopted by Constantine, and later still by the conquering Turks.

The characteristics are almost barbaric splendor united with a most effective disposition of plain surfaces, and of ornament thereon. A certain stiffness and crudeness in the outline of geometrical patterns is noticeable, with backgrounds of excessively conventional foliage, generally of the acanthus leaf. The most famous examples of Byzantine work may be seen in the churches





Frieze found at Toledo, Spain.

of Santa Sophia and others at Constantinople, and in the basilicas or early Christian Churches of Ravenna in Northern Italy, while the museums of almost all great cities of Europe contain fragments of Byzantine design in ivory carvings and mosaic or marble.

In many cases jewels were used as plain surfaces or as studs and bosses, surrounded with twisting stems of acanthus or winding stems of filigree work. The interlace was especially conspicuous and very ingeniously used. This descended to the Romanesque school where it is very often found, but often with a great deal of acanthus or other foliage forms attached. It is very difficult to distinguish properly the Byzantine from the Romanesque in many cases, so closely are they allied.

It is interesting to note how many designs in other schools are evident out-growths of Byzantine art, or at least have taken their most telling features from this source. Extreme richness seems to be the result of such borrowing, and if one will note the frequency with which the boss, in oval or round form, and the different interlaces occur in the German, Flemish, English and Italian Renaissance, he must admit their value when properly used.

Byzantine work of the best period teaches the value of contrast between

Capital, St. Mark's,  
Venice.



Carvings. St. Mark's, Venice.

plain and enriched surfaces, the strength of ornament applied to an already constructed or formed material in distinction to that which is part of the construction itself, also the value of "ornamented construction" in place of constructed ornamentation.

It is a great mistake to suppose that Byzantine art is hard and unfeeling in all its productions; certainly too many great examples prove the contrary.

We are apt, in the light of the effect which decadent work of Constantinople artists had on the early Italian painters to class it as one of the uninspired schools, but a style which could bring back, if indeed it did not excel, the ancient glory of Roman and Oriental mosaic, which successfully solved the roofing of great spaces by the arch on pendentives buttressed by semi-dome and pier, as in Santa Sophia and in the hundreds of other existing churches and mosques in the East, which influenced not only the Orient,

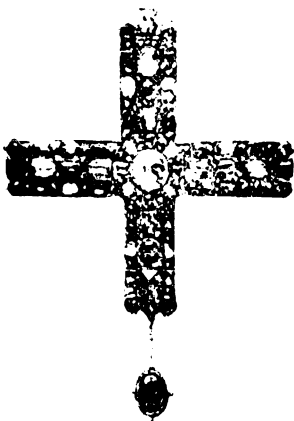
Cross of Berenger I.  
Gold and Jewels.

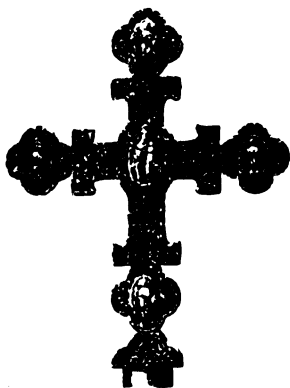

Cross in Silver Filigree.

but the Western nations also, and still continues to exert this influence, must stand among the most famous schools of ornament. Indeed, the single fact that the early Italian painters of the Renaissance were inspired by the Byzantine mosaics of Ravenna, Rome and elsewhere, alone makes it famous and enduring in the history of art.

If it were only by the great beauty of the mosaic wall decorations in Constantinople alone

that we knew Byzantine art, it would rank high, but when there is added the infinite wealth of carving which we find all through Italy, parts of the Orient and Northern Africa, full of variety and richness, we begin to realize what architects, painters, and all artists owe to Byzantium.

Bronze Gate,  
Santa Sophia.Part of Ivory Diptych,  
Beauvais Cathedral.



Yale & Towne  
Designs.

Byzantine.

*The Multipliers indicate the relative prices of the various Designs and finishes as compared with prices of corresponding pieces in the Cluny Design, Copper Finish (CX22), pages 734 and 735. For Explanation of Multipliers see page 34.*

*For Explanation of Finish Symbols see page 609.*

CONSAC—Figs. 2, 3 and 4, above . . . 4 pieces, including  
 Drawer Pulls, . . . p. 927      Key Plates, . . . p. 954  
 Appropriate Finishes: Copper (CX22) Mult'r 1.; Silver (SY52)  
 Mult'r 1.5; Gold (GY10) Mult'r 5.7

BOURNE—Fig. 5, above and Fig. 1, page 752, S. D. Handle only

ORCELLO—Fig. 1, above and Fig. 2, page 756, S. D. Handle only

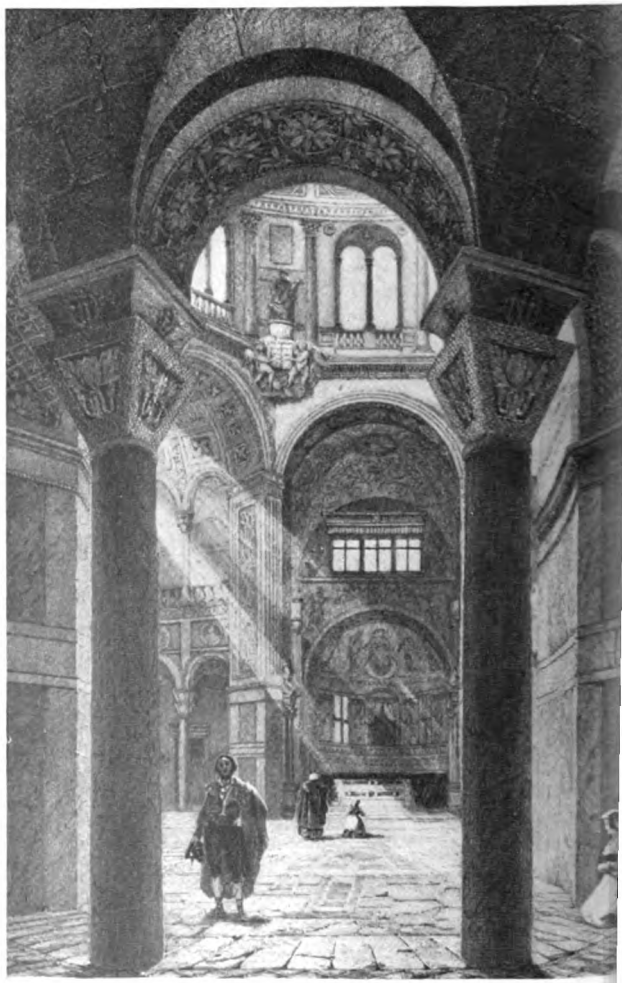

Church of St. Vital at Ravenna.

## Early Christian.

**Edict of Milan** by Constantine 313 A. D., proclaiming toleration of Christians.



EARLY Christian art partakes strongly of that of all the peoples with whom it was associated, yet it has certain phases which entitle it to a place among distinct schools.

In Italy it is strongly Roman in and about Rome, and Byzantine at Ravenna and the North of Italy, while in countries further North the Celtic vein crops out, considerably affected by Byzantine and other traditions.

The Irish priests are said to have carried their art of illumination, metal working, etc., to many of the Northern countries, Scandinavia, Germany, Switzerland, France, and even to Italy and other Southern localities, but in some places it died out, and in others the Roman and Byzantine merged with it into the Romanesque developed in Northern Italy, France, Germany, Spain and the British Isles after the fall of Rome and preceding the Gothic era.

Roman basilicas and their decorations were used by the Christians with and without alterations, and sarcophagi of classic Byzantine character, lamps, candlesticks, and other utensils were adapted to the changed religion. We find a common



Marble Cross at Torcello.



Detail from Bishop's Chair in Ivory, Ravenna.

decoration on the sarcophagi in the strigil form, possibly because the strigil being a flesh scraper, the classic marble bathing basin may have been decorated with it, and hence it possibly was copied on the sarcophagi, which were sometimes ancient bath tubs put to use for burial purposes, and, possibly, because of the wavy effect of reversed curves put side by side. In the lamps from the catacombs Christian art shows to advantage, some of them being beautiful in their simplicity and the correctness of the use of ornament, while the mosaic and marble candlesticks are often rich and harmonious in form and color.

The crosses, screens, panels, sarcophagi and marble mosaics



Detail from Bishop's Chair in Ivory, Ravenna.



Christian Sarcophagus, Lateran Museum.

and incrustations and ivory carvings of Ravenna are to-day of the greatest interest to the world, and in color the mosaics are not surpassed by any examples extant, unless it be by some of the Sicilian and Byzantine work of Southern Italy. It was from early Christian mosaics that the famous Cosmati family probably drew much of their inspiration, although the geometric patterns crowded out the reproduction of lovely imaginative designs such as are seen in the spandrels of the octagonal Baptistry at Ravenna. This is one of the finest specimens of mosaic left us, as to color and design, and a great monument of Early Christian art.

The art of this period is of great importance in that it is the bridge between Romano-Byzantine art, and that which sprang from its relics in Early Christian art, namely the art of the Renaissance. Had there been no cherishing of Byzantine and Roman work by the Early Christians, who



Capital at S. Apollinaris, Ravenna.





From the Tomb of Theodotus, Pavia, Italy.

can say how different the art of the Renaissance would have been. Certainly much of its unique quality would have been missing, and the pagan and spontaneous joyfulness in mere existence, which is so in evidence in Renaissance art, would possibly, if not entirely lost, have been so subdued as to pass unnoticed. In the Christian lamps, from the Catacombs alone, we see how Roman design was passed on down, while the adoption and adaptation of pagan divinities, (their attributes and festivals) by the Church, (although by re-naming and disguising), has preserved for us the significance of much that was liable to be forgotten. The very form of the cross antedates Christianity, and the symbols of fish, lamb, lion, grape, and much of the known flora and fauna were heirlooms which Early Christian art simply borrowed from antiquity and bequeathed to the modern world. Crude then, as we often find its manifestations, as at Torcello, Ravenna, Rome, and in other parts of Italy, besides in the Orient and on the east coast of the Adriatic, we cannot say that it was a lifeless impulse, but rather the noble struggle of untutored minds and unpracticed hands to keep alive the sacred light of learning and art for the civili-



Altar found at Ravenna.



Lamp from the Catacombs.

zation that was to come. For this reason alone we should study and honor it, and moreover from its vitality and strength we can learn simplicity, reserve, directness, and even richness in a decorative sense. The Romanesque was of course a child of Early Christian but differed from it as soon as influenced by other art in different localities. For instance, most countries had their Romanesque period, but it soon became French, Spanish, German,

English (Norman), Italian, etc., as the respective national characteristics were developed, and we can generally trace the Romanesque motives back to Early Christian ones in each case.

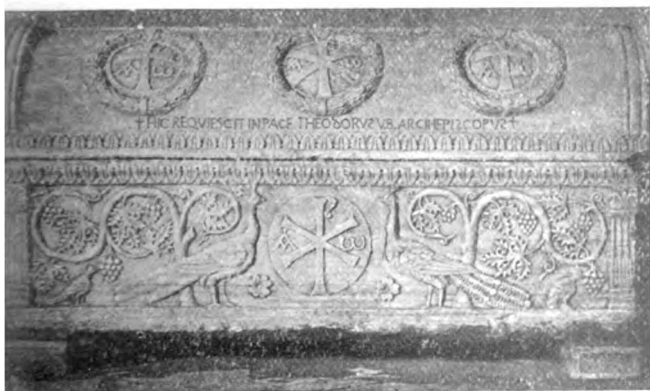

Sarcophagus of Archbishops, S. Teodoro.

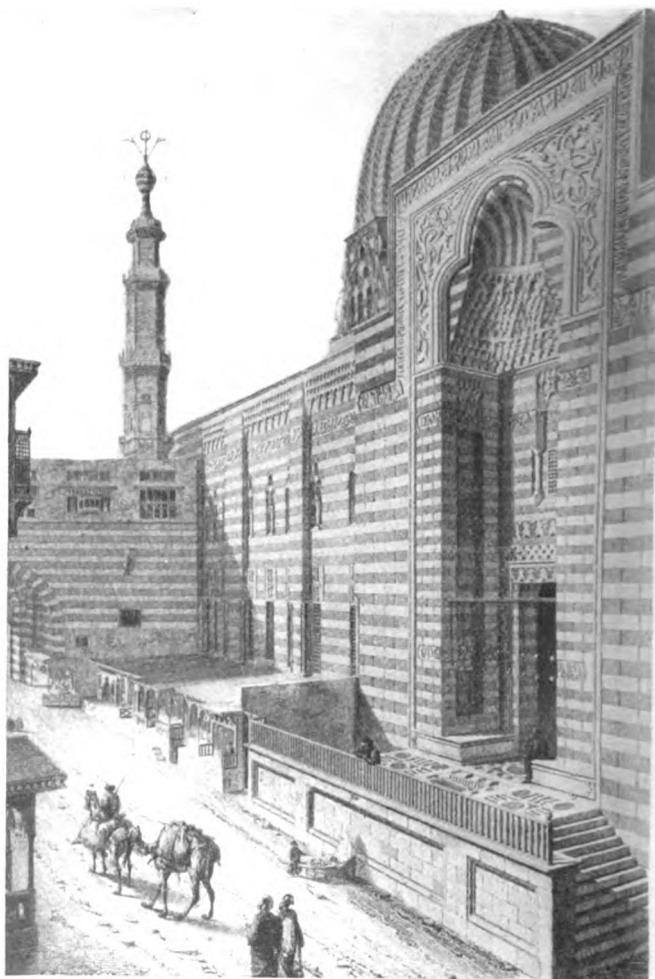

**Mosque of El-Moyed, at Cairo.**

## Saracenic.

878-1516 A. D. Mamluk period, 1250-1516 A. D.



**F** COURSE by the term Saracenic is meant that art which beginning under Mohammedan rulers in Bagdad and Damascus reached its highest development under the Mamluks and fell with the annihilation of their power by Selim in the sixteenth century. It is a generic term bestowed upon the nomads of Syria by the Romans, from which it has come to include Arab, Moor, Turk and other Mohammedans.

Hence the Saracenic school may be said to be a common source of the styles of ornament among all of these nations. The most interesting period of Saracenic art, and the most valuable to study, is that of the Mamluks from 1250 to 1516, and Stanley-Lane-Poole's works present it most fascinatingly.

To Saracenic art then we must indirectly attribute the Alhambra by the Moors and the mosques of Cairo and Damascus besides all other work which was produced through Saracenic Indian channels. We cannot in a brief description trace all its ramifications. Turkish palace and Cairene casket equally are its modern fruits though of a very inferior growth, and to know its ancient splendor, as far as we can from its remains, is to drink at a constant Pierian spring. The



Saracenic Arabesque.

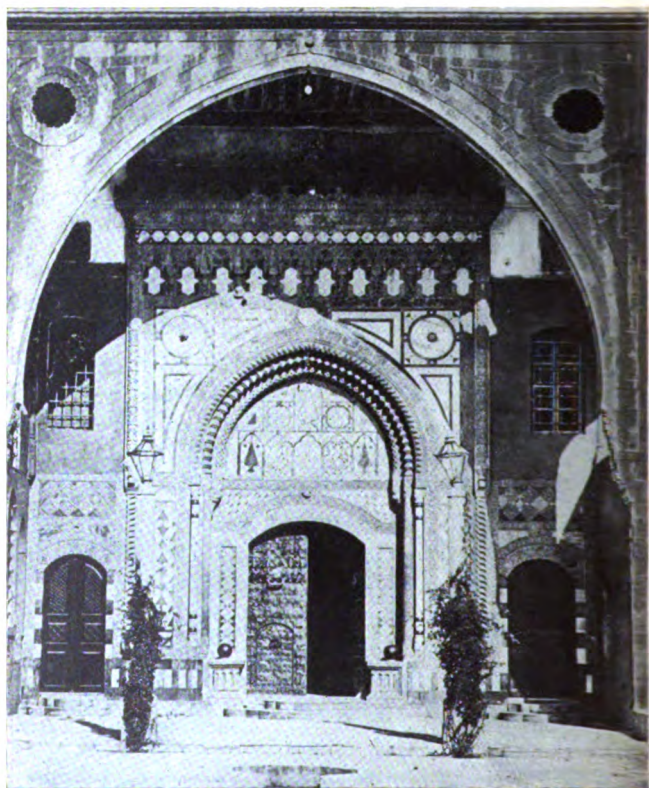

Door of Palace at Leban.

value of Saracenic art lies in the great and passionate love of beauty everywhere displayed in the imaginative creations of wonderfully gifted artists, who, working in the romantic period of Eastern art, had not yet showed signs of weakening powers, when the dynasty of the Mamluks fell. Oriental history, as



Rosette in Mosque of Sultan Hasan,  
XIVth Century.

Mr. Lane-Poole says, is a life study, and it is impossible here to tell of Saracenic art in perfect sequence, but to mention briefly its attributes and indices is enough to arouse interest in even the most careless student of art. In textile fabrics, pottery, glass-blowing, wood-turning and carvings, painting, metal-working, jewelry, mosaics, tiles, inlays

of all descriptions, stucco-modeling, stone and ivory carving, etc., etc., the Saracens were beyond rivalry, and specimens of their work, particularly of the Mamluk period are highly prized by connoisseurs and museums. Exceedingly instructive are the examples of the application of ornament and the idealization of ordinary utensils, while in the conventionalization of form, only the ancient Egyptian work can be compared to them.

The greatest possible use was made of geometrical patterns, as was natural among people who cherished the sciences, and venerated learning.

Geometry seemed to have almost a mystic symbolism in their work, and the combinations which they constantly employed were legion. This was indeed the golden age for designers, when rich men spent fortunes in beautiful objects, and the artist placed the name of the patron thereon, often to the exclusion of his own.

The Mamluk period is most valuable to the student, not only



Arabesque of Wckala of Kait Bey.  
XVth Century.



**Bronze Doors of the House of Count St. Maurice at Cairo.**

because of the great beauty of design and pattern, but also of form and color. It is, as already said, a veritable font of inspiration and to say that one is ignorant of it or is not interested



Marble Inlays, Mosque  
of the Omeyyades,  
Damascus.

in it betrays a most lamentable lack of appreciation of one of the really great periods in the history of art. There is no mistaking the joy with which these Orientals worked. Benvenuto Cellini did not labor with greater enthusiasm for Francis I than did these forgotten masters produce the exquisite works by which to-day we

recognize the unrivaled art of the Saracenic School. Honor to them and their patrons, for through their agency we see the art of an entire people raised to a sublime plane. It may be that in certain directions they have been excelled by other nations, but the wide range of their artistic triumphs is remarkable. Venice never knew more skillful glass-blowers, India no more imaginative designers and carvers, while as colorists they reached the foremost rank.

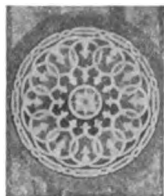

Marble Inlays, Mosque  
of the Omeyyades,  
Damascus.





**Stone Cross at Monasterboice, County Louth, Ireland.**

## Celtic.

350 to 1050 A. D. Developed by work of early Irish monks.



CHRISTIAN ornament in general partook largely of the character of the art of the people among whom Christian doctrines were spread.

Thus in northern Italy in the Early Christian period the decoration of ecclesiastical edifices was Byzantine, that being the tendency of art in that section.

In Ireland, however, where strong Celtic influences were felt, the early artists of the church worked along lines, which are so radically different from the classic, as to lead to the strong

belief that Celtic art was of independent origin or founded on Phoenician work introduced by early trading brought to high development under Christian influences, pagan as its beauty continued to be.

Here at length is a school in which the acanthus is ignored, or if suggested at all, only in such form that it cannot be definitely classed. In fact the almost total absence of



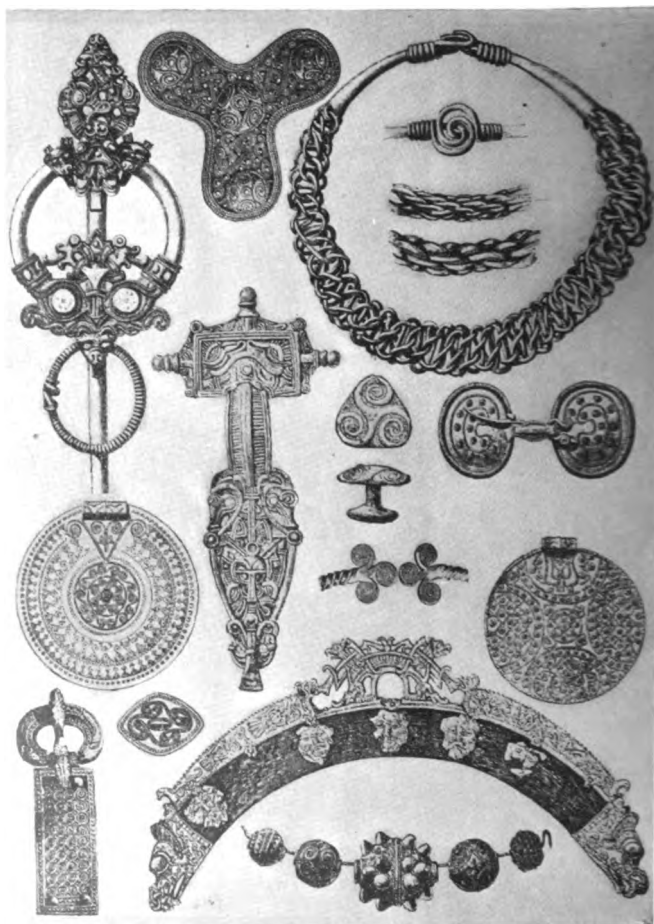

Scandinavian Jewelry, showing Celtic Character.

foliage is one of the most interesting phases of early Celtic art. As if to make up for the delicacy and intricacy of foliage the



Tara Brooch, Ireland.

is a Chinese quality to some examples, and in other patterns we trace a semblance to the gold work discovered at Mycenae, but of all the puzzling forms those based on the trumpet whorl (*i.e.* the old Irish trumpet form in the curves between the lines) are the most interesting. This ornament does not appear on MSS. after the ninth century. Another pattern is that of diagonal lines at regular distances apart, which do not interlace but give a strong Chinese effect. This has been called the Z pattern.

most beautifully minute interlaces of a geometrical character, diagonals and spirals are woven about or lead up to monstrous animal forms artistically conventionalized, or rather, invented for the very place, since they are nearer the beauties of the hobgoblin world than of our own. The knot is most tellingly introduced and is a very characteristic device. There

Frontispiece of Epistle of Jerome.  
"Book of Durrow."



Stone Cross on Slab.

It has been suggested that Celtic art was brought by very early voyagers from the East, but there is no actual proof of this. Scandinavian art was much governed by Celtic through the introduction of Christianity to the North, and even the designs of the French and the Lombards show strong Celtic influence, but there we find the acanthus introduced and the Celtic was

soon lost in the Italian and French Romanesque.

Celtic jewelry, brooches and pins, discovered in the Irish bogs, rival in intricacy and perfection of workmanship anything in fine metal-work that the world has ever known, and as for the specimens of inlaid enamel as in the chalice of Ardagh they are as beautiful as any oriental workman could have produced, and of very peculiar alloys.

In Egyptian decoration we find the rope whorl which may have suggested the trumpet whorl of Celtic art but

this is only a possibility.

Whatever its origin the beginning of Celtic ornament is remarkable in that it was developed while the rest of Europe, after the fall of Rome, was groping in a wilderness of material and intellectual ruin. As stated elsewhere, it may be that some day we shall know that the early Irish learned the secret of cloisonné from the Chinese directly or indirectly



At Kilchoman,  
Scotland.



At Kildalton,  
Scotland.

through traffic, or  
Certainly the chalice  
the world's master-

prehistoric voyages.  
of Ardagh is one of  
pieces in this art.

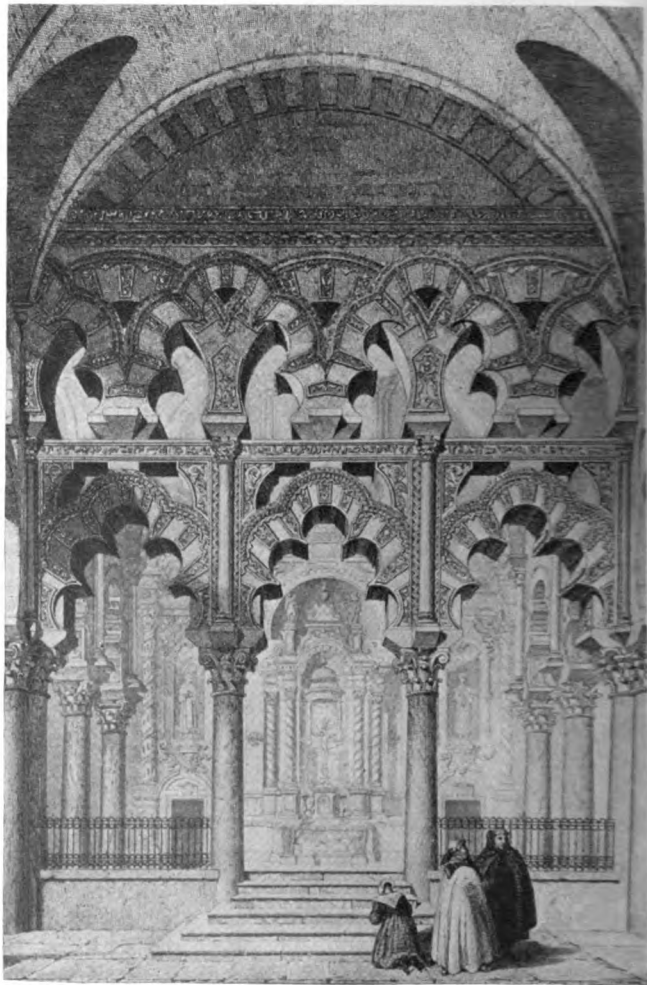

Shrine of St. Patrick's Bell, Ireland. Made 1091.

**Mosque of Cordova.**

## Moorish.

Ommiad Caliphate, 775 A. D., at Cordova. Fall of Grenada, 1492 A .D.



Capital, Alhambra.

**A**NTERIOR to the invasion by the Moors, there were in Spain, as in France, many Roman and Romanesque remains scattered through the country which had been up to that time the chief resources of inspiration for contemporary builders and designers.

Art had reached a low ebb and a few decades more might have practically killed it, when the Moors with invincible force

brought conquest in one hand and the arts of a luxurious, pleasure-loving people in the other, and taught the vanquished to produce works of which they had previously no conception.

The larger cities were speedily enriched with beautiful buildings, of which the Alhambra is to-day the best example. To be sure these were largely the handiwork of Moorish artisans, but the effect on Spanish art was far reaching.

Moorish ornament is like other branches of Saracenic design, full at times of the most intricate patterns, showing often a most delicately enriched background, upon which is displayed a heavier pattern with a flat surface.

Geometrical patterns play a most important part in it and on



Arabesque, Alhambra.





Triple Arch Ornament.

them and their variations continual changes are rung. The circle, triangle, pentagon, hexagon, etc., form the basis for outlines between which and the lines connecting them, exquisite patterns are introduced.

One of the noteworthy points of Moorish ornament lies in the skill with which the conventional treatment of the subjects was accomplished. In no case do we observe faithful transcriptions of Nature, and yet in nearly all this work the motives were derived from flowers, leaves, or other natural subjects, always conventionalized in the most effective manner.

Animal forms were excluded, being forbidden by religious prejudices, and hence the introduction of the human form, so often an inspiration to the designers of other lands, was

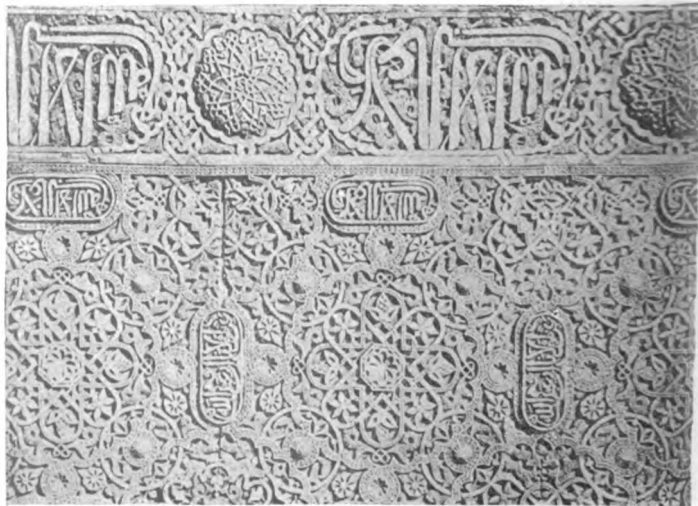

In Hall of Crowns, Alhambra.



From the Alhambra.

interesting in character and shows the possibilities of even further development. Had the Inquisition not killed Spain what greater legacies still could she have left us in architecture, painting and design in general! But such hot blood must perforce burn itself out and the Inquisition was probably the logical result of Spanish conquest and wealth.

Color plays such an important part in Moorish decoration that it cannot be painted in words; the Alhambra cannot be adequately described, it must be seen if one would take in all the beauties of this school in its best known example. Undoubtedly there is much Moorish decoration, particularly in coloring, which seems barbaric and crude, but it is never so crude and raw as many of our modern imitations.

withheld from Moorish artists.

It is hard in limited space to say what ultimate effect, the occupation of the Moors had later on Spanish ornament, but we can put it briefly that the Renaissance in Spain glows with Oriental fire, richness and color, all of which are Spanish traits largely derived from the South and East and largely due to Moorish blood.

The Mudejar style seems to be a blending of the Romanesque and the Moorish. This is very



Moorish Capital.

The Saracenic character is strong in many Moorish designs, but nowhere do we recall examples which equal the best of the creations of the Mamluk period of the Saracenic art further South and East.

What would have developed had the Moors used animal forms it is hard to say, but probably something of the nature of Persian art, but less refined, would have been the result.

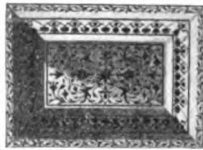

**Inlay on Beveled Surface showing Persian Influence.**

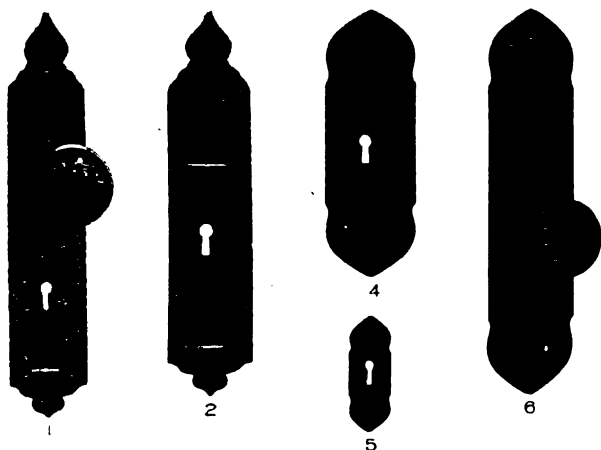

## Yale &amp; Towne Designs.

## Moorish.

The Multipliers indicate the relative prices of the various Designs and finishes, as compared with prices of corresponding pieces in the *Ciuny Design, Copper Finish (CX22)*, pages 734 and 735. For Explanation of Multipliers see Page 34.

For Explanation of Finish Symbols see page 609.

**CORDOVA**—Figs. 1 and 2, above, . . . 27 pieces, including  
 Esc'n Plates and Knobs, p. 385 . . . Flush Sash Lifts,  
 Cup Escutcheons, . . . " 905 . . . Fig. 11, . . . p. 916  
 Appropriate Finishes: Brass (AY22) Mult'r 2.2; Copper (CY22)  
 Mult'r 2.2; Silver (SX52) Mult'r 3.; Gold (GY10) Mult'r 10.2;  
 Iron (FX80) Mult'r 1.5

**TUNIS**—Figs. 4, 5 and 6 above, . . . 31 pieces, including  
 Esc'n Plates and Knobs, p. 385 . . . Push Plates, . . . p. 923\*  
 Cup Escutcheons, . . . " 906 . . . Door Pulls, . . . " 829  
 Store Door Handles, . . . " † . . . Shutter Knobs, . . . " 941  
 Flush Sash Lifts, . . . " 916\* . . . Cabinet Trim, . . . " 972n  
 Appropriate Finishes: Brass (AY22) Mult'r 2.2; Copper (CX22)  
 Mult'r 2.2; Silver (SX52) Mult'r 2.7; Gold (GY10) Mult'r 9.4

\*A few Designs only are shown as examples. \* Not illustrated.

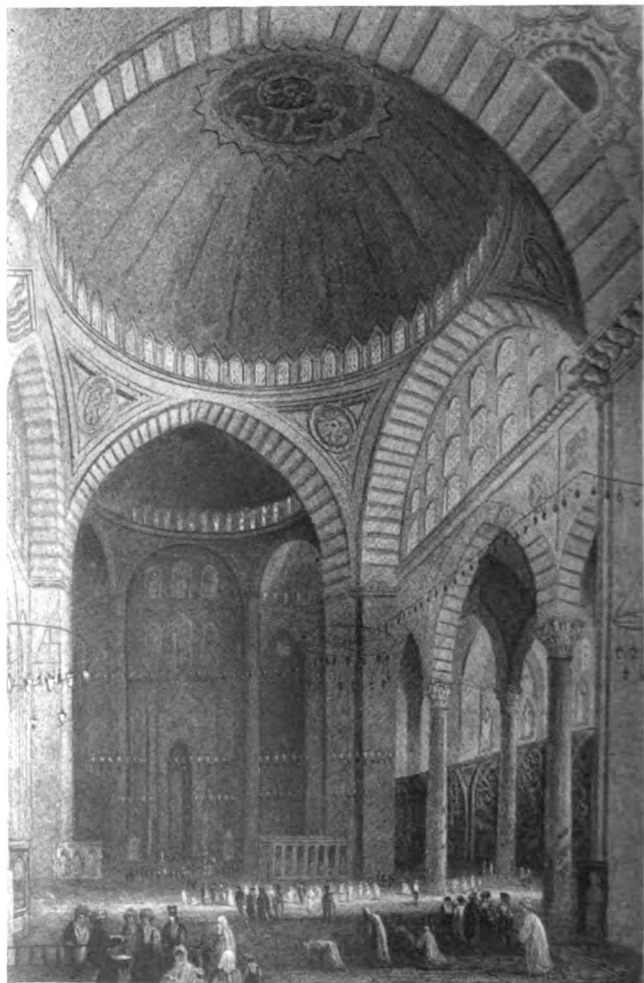

**Interior of Mosque of Süleymaniye, Constantinople.**

# Turkish.

Capture of Constantinople, 1453 A. D.



LIKE the Romans the Turks did not develop a strongly distinctive style of their own, but employing artists and artisans skilled in Arabian and Saracenic work generally, they grafted on this Oriental stock their own peculiar ideas which are not in the main those of an artistic people. The scent of barbarism hangs about their productions to-day, and their imitation of

European art, especially in architecture, has brought about the use of a hybrid style of which it is not profitable to treat.

Dealing then, rather with the earlier phases of Turkish ornament, we see in the best of it many familiar forms. The lotus has twisted itself into anthemions which but partially conceal the Saracenic influence, the interlace and the whorl take on different characters, as in most of the Saracenic design, mottoes and lettering are decoratively interspersed with the twining arabesques.

The patterns are interesting, but the colors are not blended with the skill of the Arabian, Persian, or of the Saracenic of the Mamluk period. In fact the Turk shows his fondness for gaudiness in much of his decoration. He is fond of good rugs, metal and armor, and a good judge of a beautiful object, although he prefers as most warriors do, that some one else should make it and he use it. He is certainly now a degenerate in art, though not in war. Turkish rugs as they are miscalled are largely the handiwork of the inhabitants of Asia Minor, Armenia, Persial and of other tribes which are still either nomadic or live in greater simplicity than the Turks, although they in many cases are

**Fountain at Scutari****Fountain at Galata.**



Incised Bronze.  
From the Door of the Ahmedyeh,  
Constantinople.

subject to them. This is seen by the very character of the designs, which are largely Arabian and Persian.

Turkish modeling is distinguished from the Arabian by the great use of what is called by Owen Jones the re-entering curve on the base of the anthemion, but here the Persian is somewhat like the Turkish and it is difficult to distinguish, except by reference to many examples.

The best period of Turkish art has much of the quality of the best Saracenic work of Northern Africa and Southern Spain. The fountains and some of the mosques in Constantinople are beautiful but cannot always safely be attributed to the Turks, who built over and added to existing buildings.

On the whole Turkish ornament comes lower in the scale of Oriental art than Persian, Moorish or Indian, owing to its frequent lack of imaginative quality, and the less harmonious combinations of color.





Doorway at Perrecy-Les-Forges, Allier, France.

## Romanesque.

1000 to 1150 A. D. Developed by master-builders and ecclesiastical institutions from Roman remains and Eastern suggestions introduced by traders and crusaders.



OME filled her provinces with beautiful amphitheatres, baths, basilicas or halls of justice, royal palaces, etc., and as a sequence there remained after the destruction of the Imperial City a great number of the most interesting and instructive ruins, which were converted to all sorts of uses as rapidly as the need

for new buildings was felt. Many of the most ancient structures were used as quarries whence materials for the new buildings were taken, and gradually the natural inclination was to make the new like the old, but especially in regard to ornament which was copied by the builders as well as could be, and often stolen and inserted in pieces as in the Temple St. Jean, Poitiers, France; San Michel, Pavia, Italy, and in many of the early churches and ancient dwellings. New arrangements of pattern were suggested by the old, and preserve more or less of the flavor of Roman art to this day.

In different parts of the world, however, different outside influences were brought to bear, and Romanesque was modified accordingly. Thus we have Norman, Southern France, German, Spanish and Lombard work, all of which comes properly under the general head of



Corbel Face, Angers, France.



Capitals at Elné, France.

Romanesque. It has been well defined as the school based on and preserving Roman forms, which was founded by the inhabitants of Roman colonies in Southern France, and this has generally been accepted by the foremost modern authors, M. du Caumont so christening it in 1825. Auvergne in France is filled with the best examples of French Romanesque. Here Richardson (H. H.) sought inspiration.

The wide extent of Romanesque work through Europe can be traced to the influence of conquest and colonization, notably in the cases of Norman invasions in England and Sicily, as well as in France.

The characteristics though numerous, are distinguishable but hard to define. In general massiveness, though frequently in



Capitals from Southern France, at Elné.



Storied Capital.



Leaf Forms.

later work delicacy is noticeable. The acanthus is used with sharp points as a rule, in patterns bounded with the interlace of acanthus stems and full of vigor. Rosettes of conventional form from natural sources, dentils used in rows, bulging forms in preference to receding, the convex in preference to the concave, all of them are stamps of the school. Conventionality is its strong point as in all good schools of ornament, and yet it gives the almost perfect suggestion of natural forms without ever becoming realistic.

Animal forms are largely used, birds, beasts and grotesques in profusion, and repetition of the general ideas with changed detail, but the very rudeness and crudeness of the animals makes these decorative and in keeping in the buildings of the time.



Capital showing Budding Fronds.  
H. H. Richardson's Favorite.



Interlace, Leaf and Flower  
with Animals.



In Church of  
St. Sauveur,  
Aix.

Although we have passed through a "Romanesque period" in America and are inclined to place some of Richardson's work and that of poor imitators in the same category, yet it is self-evident to the observer that to the real Romanesque and to our own experience with it, we owe much. It came at a time when there was special need of a return to simple dignity in design. Broad surfaces with simple window and door openings are better than the fussiness of the decadent German and French Renaissance from which we suffered, and to Richardson himself special praise is due that being a "Beaux Arts man" he had the strength of mind to become an eclectic and do more than to slavishly copy the school which he admired.

The effect of his work in the United States was almost as great on ornament as on architecture, and had he lived longer it is probable that through development of Byzantine motives of ornament combined with broad and more refined masses than those he had formerly used, we should have seen at least the beginning of a style applicable to a wide range of work.

Romanesque ornament in France and Italy is like the first faint notes of spring after the dismal winter of the dark ages following the fall of Rome. It is decidedly an awakening, because in spite of the temptation to continuously employ the



Cross at Clermont, Ferrand, France.



Capital of Engaged Column.  
Good example of Simple Flat Ornament  
effectively used.

classic fragments or copy them, we see constant evidences of a turning to nature for inspiration, which was later to lead to the realism of Gothic art. He who would deny to Romanesque art its proper place in the development of architecture and decoration, should first see the front of St. Gilles, in Southern France, with its triple entrance and its admirable use of bold, strong and telling, if crude ornament, and also the front of St. Trophimus at Arles, not far distant. Then let him visit in turn Elne, with its white marble cloister, and Moissac with its storied capitals, and possibly the directness, the simplicity and the meaning of it all will appeal to him as it never has before. Much of the ornament on our best modern buildings, is so utterly prosaic, meaningless and stupidly imitative of bad precedent, that the best Romanesque work is infinitely preferable.



Impost Blocks to Capitals. Southern France.



1



2



3



4



5



7



6



8



9



10



11



12

School—Romanesque.

## Yale &amp; Towne Designs. . . . . Romanesque.

The Multipliers indicate the relative prices of the various Designs and Pieces, as compared with prices of corresponding pieces in the Cluny Design, Copper Finish (CX22), pages 734 and 735. For Explanation of Multipliers see page 34.

For Explanation of Finish Symbols see page 609.

- ABBOTSFORD—Fig. 1, page 744, . . . . . 7 pieces, including  
 Esc'n Plates and Knobs, p. † Double Extension  
 Store Door Handles, . . " 745 Bolts, . . p. †  
 Appropriate Finishes: Copper (CX22) Mult'r 2.; Silver (SX52)  
 Mult'r 2.9, (SY55) Mult'r 3.6
- AGEN—Fig. 1, page 856, . . . . . Hinge Plates only.
- ALBI—Fig. 3, page 744, . . . . . Store Door Handle only.
- ASPREMONT—Fig. 16, page 857, . . . . . Hinge Plates only.
- AUMONT—Figs. 1 to 9, page 974, . . . . . Cabinet Trim only.
- AURILLAC—Fig. 2, page 831, . . . . . Door Pull only.
- AUVERGNE—Fig. 2, page 396, . . . . . 50 pieces, including  
 Esc'n Plates and Knobs, p. 396 Door Pulls, . . p. 823  
 Store Door Handles, . . " 747 Door Knockers, " 873  
 Cup Escutcheons, . . " 904 Hinge Straps, . . " 848  
 Flush Sash Lifts, . . " 916\* Push Buttons, . . " 895  
 Bar Sash Lifts, . . . . " † Push Plates, . . " 923\*  
 Letter Drop Plates, . . " 917\* Shutter Trim, . . " 922\*  
 Extension Bolts, . . . . " 894\* Cabinet Trim, . . " 965  
 Appropriate Finishes: Brass (AZ15) Mult'r 1.4; Copper (CX22)  
 Mult'r 1.4; Silver (SX52) Mult'r 1.9; Iron (FX80) Mult'r 1.
- BAYONNE—Fig. 12, page 857, . . . . . Hinge Plates only.
- BEAUCAIRE—Fig. 78, page 864, . . . . . Hinge Plates only.
- BEAUVOIR—Figs. 1 to 4, page 977,\* . . . . . Cabinet Trim only.

\* A few Designs only are shown as examples. † Not illustrated.



**BEAUMONT**—Fig. 28, page 908, . . . . . 44 pieces, including

Esc'n Plates and Knobs, p. †	Push Buttons, . p. 895
Cup Escutcheons, . . " 904	Push Plates, . . " 923*
Flush Sash Lifts, . . " 916*	Bell Pulls, . . " †
Appropriate Finishes: Copper (CX22) Mult'r 2.2; Brass (AX61) Mult'r 2.6; Silver (SY52) Mult'r 2.6; Iron (FX80) Mult'r 1.6	

**BELFORT**—Fig. 1 and 5, page 396, . . . . . 26 pieces, including

Esc'n Plates and Knobs, p. 396	Door Pulls, . . p. 824
Cup Escutcheons, . . " 904	Push Buttons, . . " 895
Flush Sash Lifts, . . " 916*	Push Plates, . . " 923*
Drawer Pulls, . . . " 925	Key Plates, . . . " 952
Appropriate Finishes: Copper (CX22) Mult'r 1.2; Silver (SX52) Mult'r 1.8; Iron (FX80) Mult'r .85	

**BERGERAC**—Fig. 9, page 831, . . . . . Door Pull only.

**BORDEAUX**—Fig. 3, page 396, . . . . . 19 pieces, including

Esc'n Plates and Knobs, p. †	Lever Handles, . p. 879
Store Door Handles, . . " 747	Door Pulls, . . . " 824
Cup Escutcheons, . . . " 904	Push Buttons, . . . " 895
Letter Drop Plates, . . . " 917*	Push Plates, . . . " 923*
Flush Sash Lifts, . . . " 916*	
Appropriate Finishes: Copper (CX22) Mult'r 3.8; Brass (AZ10) Mult'r 3.7, (AY22) Mult'r 3.8; Iron (FX80) Mult'r 1.8	

**BRIONDE**—Figs. 10 and 14, page 857, . . . . . Hinge Plates only.

**CHERBOURG**—Fig. 34, page 859, . . . . . Hinge Plate only.

**CLERMONT**—Figs. 1 to 4, page 979, . . . . . Cabinet Trim only.

**CLUNY**—Fig. 7, page 396, . . . . . 93 pieces, including

Esc'n Plates and Knobs, p. 734	Bell Pulls, . . . p. 734
Store Door Handles, . . " 735	Push Buttons, . . " 735
Cup Escutcheons, . . . " 734	Push Plates, . . . " 735
Flush Sash Lifts, . . . " 734	Hinge Straps, . . . " 734
Bar Sash Lifts, . . . . " 734	Sash Sockets, . . . " 735
Letter Drop Plates, . . . " 735	Shutter Trim, . . . " 735
Extension Bolts, . . . . " 734	Cabinet Trim, . . . " 963
Door Pulls, . . . . . " 734	

Appropriate Finishes: Copper (CX22), Base, see pages 734 and 735; Silver (SX52) Mult'r 1.79; Iron (FX80) Mult'r .75

\* A few Designs only are shown as examples. † Not illustrated.

- DAX—Figs. 1 to 4, page 978, . . . Cabinet Trim only.
- DONJON—Fig. 7, page 856, . . . Hinge Plate only.
- DOUVAINE—Fig. 5, p. 748, Door Pull and S. D. Handle only.
- DURANNO—Fig. 76, page 864, . . . Hinge Plates only.
- DURBAN—Fig. 91, page 865, . . . Hinge Plates only.
- DUXBURY—Fig. 3, page 856, . . . Hinge Plate only.
- EBRO—Fig. 4, page 396, . . . 16 pieces, including  
 Esc'n Plates and Knobs, p. 396 Push Buttons, . p. 896  
 Cup Escutcheons, . . " 905 Push Plates, . . " 923\*  
 Flush Sash Lifts, . . " 916\* Key Plates, . . " 953  
 Hook Sash Lifts, . . " †  
 Appropriate Finish: Iron (FCX22) Mult'r .25, (FX80) Mult'r .5
- ELNE—Figs. 1 to 4, page 980, . . . Cabinet Trim only.
- FOIX—Fig. 58, page 862, . . . Hinge Plates only.
- GUERET—Page 873, . . . Door Knocker only.
- JARNAC—Figs. 1 to 6, page 980, . . . Cabinet Trim only.
- LAGRASSE—Figs. 1 to 4, page 981 . . . Cabinet Trim only.
- LYONS—Fig. 6, page 396, . . . 45 pieces, including  
 Esc'n Plates and Knobs, p. † Push Buttons, . p. 896  
 Cup Escutcheons, . . " 905 Push Plates, Fig. 2 " 923  
 Flush Sash Lifts, . . " 916\* Hinge Straps, . . " 852  
 Bar Sash Lift, . . . " † Shutter Trim, . . " 922\*  
 Extension Bolts, Fig. 8, " 894 Sash Sockets, . . " †  
 Door Pulls, . . . . " 826 Cabinet Trim, . . " 971  
 Appropriate Finishes: Copper (CX22) Mult'r 1.4; Silver (SX52)  
 Mult'r 1.9; Gold (GX10) Mult'r 7.75
- MELUN—Fig. 38, page 860, . . . Hinge Plate only.

\* A few Designs only are shown as examples. † Not illustrated.

- MARGAUX**—Fig. 9, page 396, . . . 17 pieces, including  
 Esc'n Plates and Knobs, p. 396 . . . Push Plates, . . . p. 923\*  
 Cup Escutcheons, . . . " 905 . . . Hinge Straps, . . . " 852  
 Push Buttons, . . . p. 896  
 Appropriate Finishes: Copper (CX22) Mult'r 1.4; Silver (SX52)  
 Mult'r 2.; Gold (GX10) Mult'r 9.4; Iron (FX80) Mult'r 1.
- MONTAUBAN**—Figs. 1 to 4, page 981, . . . Cabinet Trim only.
- MONTINS**—Fig. 39, page 860, . . . Hinge Plate only.
- MURAT**—Fig. 98, page 866, . . . Hinge Plate only.
- NARBONNE**—Fig. 3, page 839, . . . Door Pull only.
- NEVERS**—Fig. 4, page 839, . . . Door Pull only.
- NIMES**—Fig. 10, page 396, . . . 43 pieces, including  
 Esc'n Plates and Knobs, p. 396 . . . Door Pulls, . . . p. 827  
 Store Door Handles, . . . " 753 . . . Push Buttons, . . . " 897  
 Cup Escutcheons, . . . " 906 . . . Push Plates, . . . " 923\*  
 Flush Sash Lifts, . . . " 916\* . . . Hinge Straps, . . . " †  
 Drawer Pulls, . . . " 927  
 Appropriate Finishes: Brass (AZ10) Mult'r 2.25; Copper (CX22)  
 Mult'r 2.4; Iron (FX80) Mult'r 4.4
- NOVARA**—Figs. 62 and 64, page 862, . . . Hinge Plates only.
- PAU**—Fig. 36, page 859, . . . Hinge Plate only.
- PRADES**—Fig. 96, page 866, . . . Hinge Plate only.
- REALMONT**—Fig. 8, page 396, . . . 55 pieces, including  
 Esc'n Plates and Knobs, p. 396 . . . Bar Sash Lift, . . . p. †  
 Store Door Handles, . . . " 755 . . . Door Pulls, . . . " 828  
 Cup Escutcheons, . . . " 906 . . . Push Buttons, . . . " 897  
 Flush Sash Lifts, . . . " 916\* . . . Push Plates, . . . " 923\*  
 Letter Drop Plates and . . . Shutter Trim, . . . " 922\*  
 Hood, Figs. 13 & 14 " 917 . . . Cabinet Trim, . . . " 972B  
 Extension Bolts, Fig. 2, " 894  
 Appropriate Finishes: Copper (CX22) Mult'r 1.3; Silver (SX52)  
 Mult'r 2.; Iron (FX80) Mult'r 1.

\* A few Designs only are shown as examples. † Not illustrated.

- RUDEZ—Fig. 44, page 860, . . . Hinge Plate only.
- ROKEBY—Fig. 11, page 396, . . . 29 pieces, including  
 Esc'n Plates and Knobs, p. 396 Bar Sash Lifts, . p. †  
 Store Door Handle, . " 760 Push Buttons, . " 897  
 Cup Escutcheon, . . " 906 Push Plates, . " 923\*  
 Letter Drop Plates . . " 917\* Shutter Knobs, . " 941  
 Extension Bolts, Fig 6, " 894 Key Plates, . . " 955  
 Flush Sash Lifts, . . . " 916\*
- Appropriate Finishes: Copper (CX22) Mult'r 1.4; Brass (AX61)  
 Mult'r 1.8; Iron (FX80) Mult'r 1.
- ROQUEFORT—Fig. 51, page 861, . . . Hinge Plate only.
- ROYAT—Fig. 41, page 860, . . . Hinge Plate only.
- SALIGNAC—Fig. 77, page 864, . . . Hinge Plate only.
- TARBES—Fig. 2, page 856, . . . Hinge Plate only.
- TOURAINÉ—Fig. 12, page 396, . . . 20 pieces, including  
 Esc'n Plates and Knobs, p. 396 Door Pulls, . . p. 829  
 Store Door Handles, . " 757 Push Buttons, . " 897  
 Cup Escutcheons, . . " 906 Push Plates, . " 923\*  
 Flush Sash Lifts, . . . " 916\*
- Appropriate Finishes: Copper (CX22) Mult'r 1.3; Silver (SX52)  
 Mult'r 1.8; Iron (FX80) Mult'r 1.
- TULLE—Fig. 11, page 857, . . . Hinge Plate only.
- VALENCE—Figs. 1 to 4, page 989, . . . Cabinet Trim only.

\* A few Designs only are shown as examples. † Not illustrated.

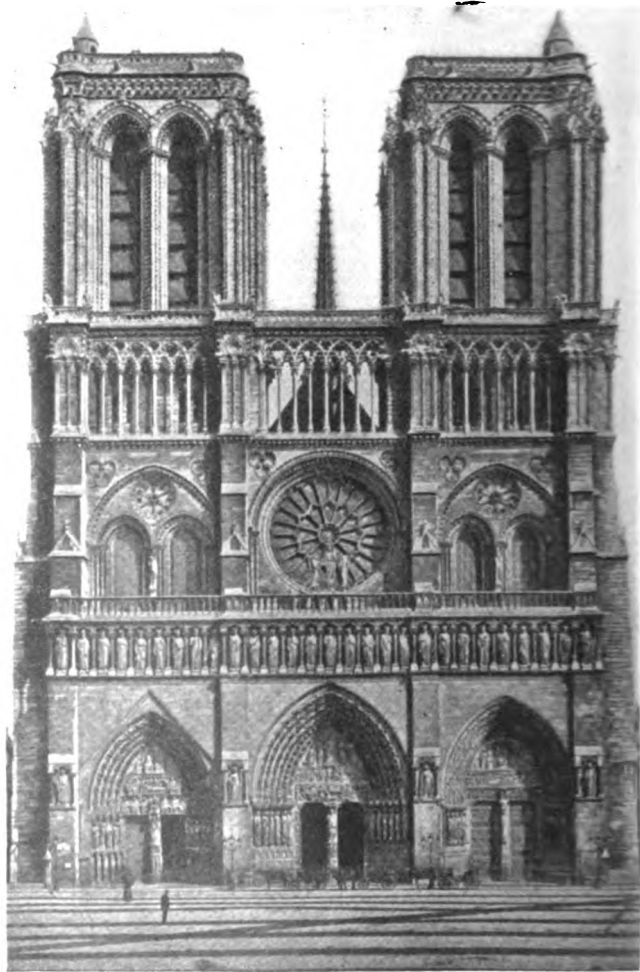

Facade of Cathedral of Notre Dame, Paris.

# Gothic.

1150 to 1450 A. D. Developed chiefly by ecclesiastical institutions, in cathedral and church building.

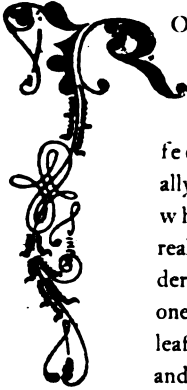

ROMANESQUE ornament had no general decline according to our standard, except in certain districts, where a transitional style is noticeable, which was hard, unfeeling and displeasing as a rule. Generally speaking, it passed into early Gothic which changed to the gradually increasing realism of later Gothic discernible in the rendering of natural forms. The classic acanthus one sees giving way to the natural types of leaf and stem, until oak, ivy, seaweed or kelp and other natural forms are represented, first conventionally and then in a very realistic way

which at last becomes tiresome in its decline and suggestive of the uselessness of man's competing with nature on her own ground, that is, of attempting to use natural forms with less and less conventionality.

The early Gothic ornament, however, is interesting and exceedingly vigorous. It possesses much of the life of the Romanesque conventionality and straightforwardness, is adaptable to many of our modern needs, and is more refined than Romanesque.



In brief then, we may say of the

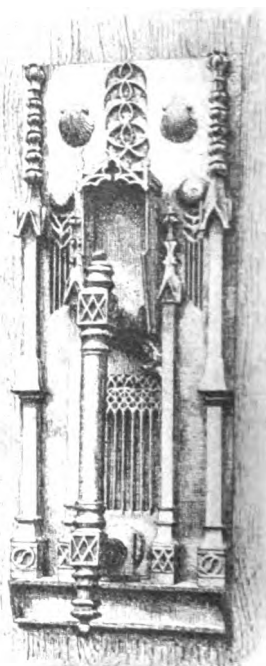
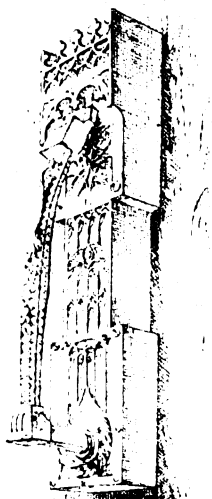

Knockers.  
From Houses in Zurich, Beaune, Cluny and Bourges.



Lockplate.

Gothic that its later characteristics are greater freedom, than in its predecessors, from conventionality and a greater leaning towards realism until its decay and the dawn of the Renaissance.

The trefoil, quatrefoil, etc., are distinguishing marks of the style, also a certain roundness or convexity of the ends of leaves in trefoils, etc.

In England Gothic went through the periods of Early English; Lancet, 1189-1307; Decorated, 1307-1377; Perpendicular, 1377-1485; Tudor, 1485-1546.

It is strange that while Gothic architecture went further and further into geometrical niceties of form and construction, its attendant ornament should, in spite of the frequent restraint of geometrical designs, be tending in its use of foliage and stems

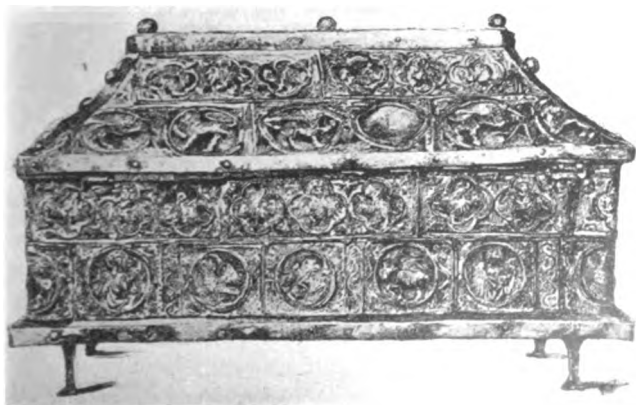

Reliquary. XIII Century. German Museum Nuremberg.





Fire-Dog,  
Vergenay, France.

more and more toward freedom from conventionality or realism, *i. e.* close imitation of nature which in every school proves disastrous. In Germany the workers of metal became finally such copyists of natural forms as to represent the bark of trees, and sections where the axe had supposedly lopped off the branch. Pure and simple copying acts on the imagination of the designer like opium, killing in the end all traces of life, originality or inspiration. Design cannot live without the proper use of conventionality which demands of the designer that he must use nature not as a copy book, but study her as a means of filling his mind with her suggestions. An ounce of suggestion in design is worth a pound of realism. While realism demands in its execution a high degree of technical skill it is quite possible for that skill to be acquired merely



Candlestick,  
St. Germain des Pres,  
XIII. Century

by practice and in spite of an almost entire absence of true artistic feeling. Of course in each century as in the growth of the Renaissance, we find national characteristics changing



Knocker at Troyes

the style from its early formality and simplicity. In Spain it acquires a romantic and graceful freedom, and similarly in France, while in England the several periods which we have alluded to were developed. Germany and the neighboring lands produced wonderfully beautiful

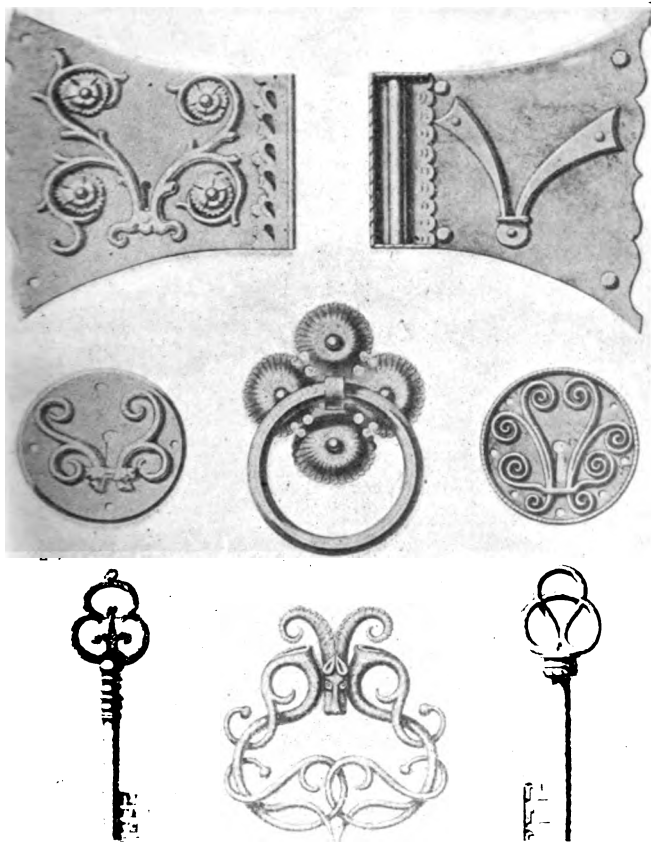

Medieval Hardware.

Gothic ornament in the woodwork of the day, examples of which have come down to us in chests, chairs, wainscots, etc., in the old chateaux and the national museums.

France perhaps more than any other country made Gothic

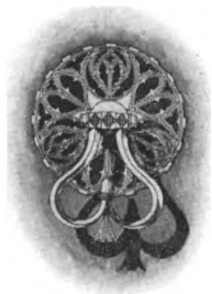

Door Ring, XV Century, French.

and no better plea for the logic of both could be made than the interpretation of Gothic which his language and drawings afford. A style which has vitality shows



Knocker, XV Century, French.

the truest vehicle of national expression, due no doubt to the great admixture of Gothic blood in her people.

Viollet-le-Duc in his *Dictionnaire* has made of Gothic one of the most remarkable monographs of French architecture and ornament,

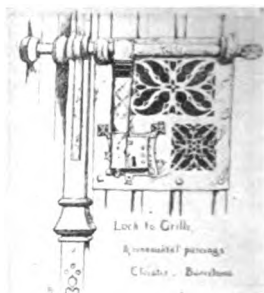

In Cloister, Barcelona.

when it has reached its highest plane it must necessarily give way, and the true spirit of Gothic art is dead and has been ever since the Middle Ages. Mysticism produced it, science killed it.

But although the old Gothic spirit died after the invention of printing, and most of the work done as Gothic since then, was designed really in reminiscence and love of the departed school, yet we still see it affecting the art of

our own day. In *l'Art Nouveau* we find a very decided Gothic treatment in the most noteworthy examples, in fact so strong is the Gothic suggestion that we are inclined to believe that in this direction lies the greater possibilities of this new school. It seems as if the long swerving lines suggestive of stem growth were common to both. If this is

true it  
bears

at what we notice in German Renaissance that if the efforts of the early artists to follow the best and most imaginative of the Gothic ornaments had been followed up by the later designers, a stronger school than the Renaissance would have arisen. Of course this is mere speculation, but, perhaps, not wholly idle.



Door Ring.



Knocker.



1



2



3



4



5



6



9



10



7



8



11



12

## Yale &amp; Towne Designs. . . Gothic.

The Multipliers indicate the relative prices of the various Designs and finishes as compared with prices of corresponding pieces in the Cluny Design, Copper Finish (CX22), pages 734 and 735. For Explanation of Multipliers see page 34.

For Explanation of Finish Symbols see page 609.

ALENCON—Figs. 1, 5 and 6, page 410, . . . 36 pieces, including

Esc'n Plates and Knobs, p. 410	Letter Drop Plates p. 917*
Store Door Handles, . . " 745	Door Knockers, " 873
Cup Escutcheons, . . " 904	Door Pulls, . . " 823
Drawer Pulls, . . . " 925	Push Buttons, . . " 895
Flush Sash Lifts, . . . " 916*	Push Plates, . . " 923*
Bar Sash Lifts, . . . " †	Key Plates, . . . " 952

Appropriate Finishes: Copper (CX22) Mult'r 1.75; Silver (SX52) Mult'r 2.5; Iron (FX80) Mult'r 1.25

AMIENS—Fig. 2, page 410, . . . . . 14 pieces, including

Esc'n Plates and Knobs, p. 410	Push Buttons, . p. 895
Cup Escutcheons, . . " 904	Hinge Straps, . . " 847
Flush Sash Lifts, . . . " 916*	

Appropriate Finishes: Copper (CX22) Mult'r 12.; Silver (SX52) Mult'r 14.; Iron (FX80) Mult'r 11.

AUBIGNY—Fig. 23, page 858, . . . . . Hinge Strap only.

BEAUVAIS—Figs. 3 and 8, page 410, . . . 18 pieces, including

Esc'n Plates and Knobs, p. 410	Push Buttons, . p. 895
Store Door Handles, . . " 747	Push Plates, . . " 923*
Cup Escutcheons, . . " 904	Kick Plates, . . " 870*
Flush Sash Lifts, . . . " 916*	Hinge Straps, . . " 848
Door Pulls, . . . . . " 824	Key Plates, . . . " 952

Appropriate Finishes: Brass (AZ10) Mult'r 2., (AY22) Mult'r 2.1; Bronze (BY14) Mult'r 2.1; Silver (SY52) Mult'r 2.7; Iron (FX80) Mult'r 1.5

BELLAS—Fig. 11, page 874, . . . . . Door Knocker only.

BENNINGTON—Fig. 71, page 863, . . . . . Hinge Strap only.

BERNAY—Fig. 32, page 859, . . . . . Hinge Plate only.

\* A few Designs only are shown as examples. † Not illustrated.

- BREST**—Fig. 79, page 864, . . . . Hinge Plates only.
- CAEN**—Figs. 1 to 3, page 979, . . . . Cabinet Trim only.
- CANTERBURY**—Fig. 1, page 748, . . . . 4 pieces, including  
 Store Door Handles, . . p. 749                      Push Plates, . . p. 923\*  
 Door Pulls, . . . . , 824  
 Appropriate Finishes: Copper (CX22) Mult'r 3.1; Brass (AY22) Mult'r 3.1; Silver (SX52) Mult'r 4.2; Green Bronze (BX67) Mult'r 4.2; Iron (FX80) Mult'r 2.3
- CHALONS**—Fig. 81, page 864, . . . . Hinge Plates only.
- COBURG**—Fig. 4, page 410, . . . . 26 pieces, including  
 Esc'n Plates and Knobs, p. 410                      Door Pulls, . . p. 824  
 Cup Escutcheons, . . " 904                      Push Buttons, . . " 895  
 Flush Sash Lifts, Fig. 5, " 916                      Push Plates, . . " 923\*  
 Appropriate Finishes: Brass (AY22) Mult'r 2.; Silver (SX52) Mult'r 2.8; Iron (FX80) Mult'r 1.5
- DIEPPE**—Fig. 4, page 856, . . . . Hinge Plate only.
- EPERNAY**—Figs. 1 to 4, page 978, . . . . Cabinet Trim only.
- EVEREUX**—Fig. 3, page 874, . . . . Door Knocker only.
- FLAVIGNY**—Fig. 90, page 865, . . . . Hinge Plate only.
- FLORENSAC**—Fig. 9, page 410, . . . . 8 pieces, including  
 Esc'n Plates and Knobs, p. 410                      Push Buttons, . . p. 896  
 Store Door Handles, . . " 751                      Push Plates, . . " 923\*  
 Door Pulls, . . . . " 825  
 Appropriate Finishes: Copper (CX22) Mult'r 3.; Silver (SX52) Mult'r 3.8; Iron (FX80) Mult'r 2.3
- GIRONDE**—Fig. 43, page 860, . . . . Hinge Plates only.

- GRANVILLE—Fig. 31, page 859, . . . Hinge Plate only.
- GREENFIELD—Fig. 92, page 866, . . . Hinge Strap only.
- LIRY—Figs. 1 to 8, page 985, . . . Cabinet Trim only.
- KELP—Fig. 10, page 410, . . . 56 pieces, including
- |                                |                          |
|--------------------------------|--------------------------|
| Esc'n Plates and Knobs, p. 410 | Door Pulls, . . p. 826   |
| Store Door Handles, . . " 751  | Bell Pulls, . . " †      |
| Cup Escutcheons, . . " 905     | Hinge Straps, . . " 851  |
| Flush Sash Lifts, . . " 916*   | Push Buttons, . . " 896  |
| Bar Sash Lifts, . . . " †      | Push Plates, . . " 923*  |
| Letter Drop Plates, . . " 917* | Shutter Trim, . . " 922* |
| Chain Door Fasteners. . . " †  | Sash Sockets, . . " †    |
| Butts, Fig. 1, . . . " 919     | Cabinet Trim, . . " 970  |
| Extension Bolts, . . . " 894*  |                          |
- Appropriate Finishes: Copper (CX22) Mult'r 1.3; Iron (FX80) Mult'r 1.
- MURANO—Figs. 11 and 12, page 410, . . . 9 pieces, including
- |                                |                           |
|--------------------------------|---------------------------|
| Esc'n Plates and Knobs, p. 410 | Flush Sash Lifts, p. 916* |
| Cup Escutcheons, . . " 906     | Push Plates, . . " 923*   |
- Appropriate Finishes: Copper (CX22) Mult'r 2.1; Silver (SX52) Mult'r 2.75, (SY55) Mult'r 3.5; Gold (GY10) Mult'r 11.5
- NANTES—Fig. 22, page 858, . . . Hinge Plates only.
- PESARO—Fig. 84, page 865, . . . Hinge Plate only.
- PISA—Fig. 82, page 865, . . . Hinge Strap only.
- RIVA—Fig. 40, page 860, . . . Hinge Plate only.
- SAARBRUCK—Fig. 7, page 410, . . . 31 pieces, including
- |                                |                           |
|--------------------------------|---------------------------|
| Esc'n Plates and Knobs, p. 410 | Hinge Straps, . . p. 854  |
| Cup Escutcheons, . . " 906     | Push Plates, Fig. 4 " 923 |
| Flush Sash Lifts, . . " 916*   | Cabinet Trim, . . " 972B  |
| Door Pulls, . . . " 828        |                           |
- Appropriate Finishes: Copper (CX22) Mult'r 2.6; Silver (SX52) Mult'r 3.3; Gold (GX12) Mult'r 11.; Iron (FX80) Mult'r 1.9
- TOURS—Figs. 1 to 4, page 989, . . . Cabinet Trim only.

\*A few Designs only are shown as examples. † Not illustrated.



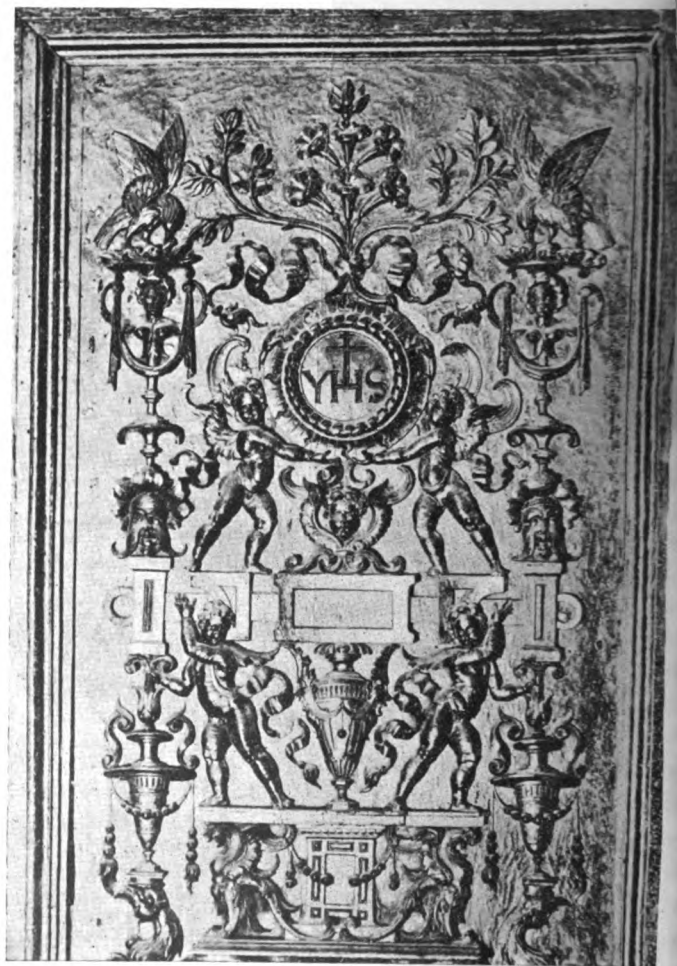

Carved Panel in Choir, S. Agostino Perugia.

Palace Ugucioni, Florence.

## Italian Renaissance.

Quattrocento, 1300-1400; Early Renaissance or Quattrocento, 1400-1500; Brunelleschi, 1377-1446; Donatello, Ghiberti, Michelozzi, San Gallo, Luca della Robbia, Alberti, 1404-72; Pietro Lombardo, Fra Giocondo.  
Renaissance or Cinquecento, 1500-1600; Bramante, Primaticcio, Ballesarre, Peruzzi, Raphael, Giulio Romano, Sansovino, Scamozzi, Sanmichele, Michelangelo, Vignola, Vasari, Palladio, Galeazzo Alessi;  
Baroque, 1600-1800; Martino Lunghi, Richini, Lorenzo Bernini, Borromini, Vanvitelli.



LOSELY after the Gothic came the Renaissance school, which was the result of the return of the world of art and science to classic precedent; a new-born appreciation of the beauties of Greek art and letters which swept over Europe, and particularly over Italy and

France like a tidal wave of new conceptions. It produced many beautiful and finally many frightful results. Society was led into great excesses, and even the heathen deities set again on their pedestals, but arts and letters and civilization were advanced. Possibly the French Revolution was the greatest product of the Italian Renaissance. Hence, we see in the ornament of that age great liberties taken with stem, foliage and animal forms. Satyrs, cherubs, beasts, birds and fish were often used indiscriminately as the vehicles of inspiration.



Design by Agostino Veneziano  
Uffizi, Florence.



Vase from old French Lithograph.



Frescoes in Ducal Palace, Mantua.



CANTHUS, lily, palm, and all the classic forms are repeated often with shields, coats of arms, garlands of fruit or flowers tied with waving ribbons, and great care taken as a rule, with the modeling of all of them, the relief often being slight, and the modeling most delicate.

Nymphs are represented with their bodies growing into acanthus forms which in turn become slender, and often beautifully graceful stems, only to swell out again into fresh exuberance of leaf or flower curling constantly into circular or spiral growths, to end probably in a rosette or central flower.

All this partakes of the art of Rome and the East. It is like a Bacchic revel of design, and the thyrsus is frequently not wanting, nor Bacchus himself and his crew with the vine and its products represented.

Once in a while there is a pause in the procession, and some one turning to the Byzantine school produces an interlace singly or repeated, but it is handled so differently with a certain delicate treatment that we recognize at once that it is not Byzantine, or even Romanesque, but a Renaissance adaptation.

To distinguish French, German and Italian Renaissance, a knowledge



Vase of 16th Century.



Bellows in Carved Wood,  
South Kensington.

of the national characteristics is a great aid. In the Italian, there is suggested sentiment, poetry and luxury; in the French, beauty and vivacity; and in the German, a round, easy-going curve to the constantly twisting leaves with their fleshy, round ends that suggest no great originality, but easy good-nature; all three national sub-divisions to pass soon into all the horrors of Baroque design without thought or end, until extinction.

To appreciate the full beauty of the ornament of this period it is necessary to study in detail the mural decorations of the palaces and villas. Much has been destroyed, but so much remains that it is not only of great value to modern art, but tells truthfully the story of the impetuous impulse to design and decorate, which



Ancient Nutwood Chest.



Wrought-Iron Knocker,  
Siena.

the Renaissance constantly manifests. The creative force must have been stronger than moderns can easily gauge, and the further we search the more the evidences multiply not merely of the great art inherent in the Italian temperament, but of the mere nervous strength and mental and bodily vigor which was required to complete such works. It is the old Gothic, Vandal and Teutonic blood of the early invaders which joined to the latent Etruscan, Greek and Roman strain produced such results. We see its physical evidence in the endurance of the Italian laborer

who to-day can probably work more hours a day and live on less than any other nationality, except possibly the Chinese or tireless Japanese.

The effect of the fall of Constantinople and the consequent dissemination of arts and letters upon a field so fertile as Italy in the fifteenth century, can be compared to the effect which Egyptian and Eastern Art had previously had upon the Greeks. It was the result to be expected; prince and subject, noble and citizen took up the pursuit of knowledge with eagerness, and minds starved by the barrenness of mediæval learning in Europe were full-fed; for then at length from this sowing came



Bronze Knocker,  
by Gian Bologna.



Ornamental Base of  
Standard.

houses of the orient were emptied by their enthusiastic researches and unremitting zeal.

If one can visit, or study from books, prints and photographs, such examples as are in the Vatican, and the best of the Roman Florentine, Venetian and other palaces and also the villas in and about the principal Italian cities, all that has been said is more forcibly presented, than can be conveyed by description or print.

It may be safely said that there is nothing to take the place of personal observation. Its value to a designer is great, and although the usefulness of prints and photographs is not to be disputed, yet no one can feel well

flower and fruit such as few nations have produced and the reign of intellect gradually succeeded to the rule of absolute physical force, not but what there was still blood-letting enough to gratify even the mediæval mind, but hand in hand with the wars and petty broils went learning, art and the æsthetic enjoyment which these brought, so that in his leisure at least, the prince, duke or other tyrant, heaped favors on his court architect or painter, and bettered the daily life of his subjects. The Italians became great worshippers of the antique in all forms, and the libraries and treasure



Arabesque on  
Pilaster.



Keyless Lock, opened  
by turning finial  
knobs.

the architect to see how certain sizes of mouldings appear in certain places on actual structures. The drawing alone is not enough; we must see the effect of contrasts between plain and ornamented surfaces, of light and shade, and of stated distance from the average spectator's eye. All these are problems, which personal inspection alone can solve.

trained either for the practical application of his knowledge or for mere enjoyment, who has not enjoyed the advantage both of personal observation and of sketches from the real object itself, while architectural students should go farther and use the lead strip and tape line. It is moreover of great value to those who are studying the use of ornament on buildings to see the ornament full size on the building itself just as it is of value to



Carved Arabesque Panel.



ADRIA  
Fig. 1ADRIA  
Fig. 2BERGAMO  
Fig. 3CERTOSA  
Fig. 4FLORENCE  
Fig. 5GENOVA  
Fig. 6FLORENCE  
Fig. 7FLORENCE  
Fig. 8FLORENCE  
Fig. 9FLORENCE  
Fig. 10



SENNA  
Fig. 11



MEDICI  
Fig. 12



MILAN  
Fig. 13



PALERMO  
Fig. 14



RIALTO  
Fig. 16



SENA  
Fig. 15



TOSCA  
Fig. 17



TREVISO  
Fig. 18



URBINO  
Fig. 19

School—Italian Renaissance.

## Yale & Towne Designs. Italian Renaissance.

The Multipliers indicate the relative prices of the various Designs and finishes, as compared with prices of corresponding pieces in the Cluny Design, Copper Finish (CX22), pages 734 and 735. For Explanation of Multipliers see page 54.

For Explanation of Finish Symbols see page 607.

### ADRIA—Fig. 1, page 422, . . . . . 15 pieces, including

Esc'n Plates and Knobs, p. 422	Cylinder Faces, Fig. 5, . . . p. 924
Store Door Handles, . . . " 759	Door Pulls, . . . . . " 823
Cup Escutcheons, . . . " 904	Push Buttons, . . . . . " 895
Letter Drop Plates, . . . " 917*	Push Plates, . . . . . " 923*
Flush Sash Lifts, . . . . " 916*	

Appropriate Finishes: Copper (CX22) Mult'r 3.2; Silver (SX52) Mult'r 9.1; Gold (GY10) Mult'r 13.; Iron (FX80) Mult'r 2.4

### ANCONA—Fig. 8, page 744, . . . . . Store Door Handle only.

### ARNO—Fig. 2, page 422, . . . . . 17 pieces, including

Esc'n Plates and Knobs, p. 422	Extension Bolts . . . . . p. 894*
Store Door Handles, . . . " 745	Push Buttons, . . . . . " 895
Cup Escutcheons, . . . " 904	Push Plates, . . . . . " 923*
Flush Sash Lifts, . . . . " 916*	Cabinet Trim, . . . . . " 904
Hook Sash Lifts, . . . . " †	

Appropriate Finish: Copper Plated on Iron (FC17) Mult'r .25

### BERGAMO—Fig. 3, page 422, . . . . . 39 pieces, including

Esc'n Plates and Knobs, p. 422	Door Pulls, . . . . . p. 824
Store Door Handles, . . . " 747	Push Buttons, . . . . . " 895
Cup Escutcheons, . . . " 904	Push Plates, . . . . . " 923*
Flush Sash Lifts, . . . . " 916*	Hinge Plates, . . . . . " 848

Appropriate Finishes: Copper (CX22) Mult'r 2.75; Bronze (BX67) Mult'r 3.5; Silver (SX52) Mult'r 3.5; (SY55) Mult'r 4.2; Gold (GY10) Mult'r 11.2

### CARRARA—Fig. 16, page 930, . . . . . Drawer Pull only.

### CASALE—Fig. 9, page 818, . . . . . Lever Handle only.

### CATANIA—Fig. 2, page 748, . . . . . 3 pieces, including

Store Door Handles, . . . p. 749	Push Plates, . . . . . p. 923*
Door Pulls, . . . . . " 824	

Appropriate Finishes: Copper (CX22) Mult'r 3.2; Brass (AY22) Mult'r 3.2; Silver (SX52) Mult'r 4.3; Green Bronze (BX67) Mult'r 4.3; Iron (FX80) Mult'r 2.4

### CERTOSA—Fig. 4, page 422, . . . . . 11 pieces, including

Esc'n Plates and Knobs, p. 422	Push Buttons, . . . . . p. 895
Cylinder Faces, Fig. 10, " 924	Push Plates, . . . . . " 921*
Lever Handles, . . . . . " 879	

Appropriate Finishes: Copper (CY22) Mult'r 2.8; Silver (SX52) Mult'r 3.5; (SY55) Mult'r 4.2; Green Bronze (BX67) Mult'r 3.5; Gold (GZ10) Mult'r 9.6

\*A few Designs only are shown as examples. † Not illustrated.

**CEVA**—Fig. 3, page 748, . . . . . 3 pieces, including  
 Store Door Handle, . . . p. 749      Push Plates, . . . . . p. 923\*  
 Door Pulls, . . . . . " 824

Appropriate Finishes: Copper (CX22) Mult'r 3.5; Silver (S52) Mult'r 4.2,  
 Iron (FX80) Mult'r 2.

**DOLPHIN**—Figs. 2 and 3, page 834, . . . Pull Handle only.

**ETRURIAN**—Fig. 5, page 422, . . . . . 13 pieces, including

Esc'n Plates and Knobs, . . . p. 422	Push Buttons, . . . . . p. 896
Cup Escutcheons, . . . " 905	Push Plates, . . . . . " 923*
Flush Sash Lifts, . . . . . " 916*	Key Plates, . . . . . " 953

Appropriate Finishes: Bronze (BZ37) Mult'r .5; Copper (CZ17) Mult'r .5

**FASSANO**—Fig. 41, page 958, . . . . . Key Plate only.

**FERRARA**—Fig. 7, page 422, . . . . . 41 pieces, including

Esc'n Plates and Knobs, . . . p. 422	Butts, Figs. 6 and 7, . . . p. 919
Cup Escutcheons, . . . " 905	Bell Pulls, . . . . . " †
Cylinder Faces, Fig. 2, " 924	Hinge Plates, . . . . . " 850
Flush Sash Lifts, Fig. 9, " 916	Push Buttons, . . . . . " 896
Bar Sash Lifts, . . . . . " †	Push Plates, . . . . . " 923*
Extension Bolts, . . . . . " 894*	Shutter Trim, Figs. 1 and
Flush Bolts, . . . . . " †	4, . . . . . " 922
Door Pulls, . . . . . " 825	Cabinet Trim, . . . . . " 968

Appropriate Finishes: Copper (CY22) Mult'r 3.25; Silver (SX52) Mult'r 3.75;  
 Gold (GZ10) Mult'r 10.; Hand Chasing, Mult'r 2.6 additional.

**FLORENTINE**—Fig. 8, page 422, . . . . . 20 pieces, including

Esc'n Plates and Knobs, . . . p. 422	Bell Pulls, . . . . . p. †
Cup Escutcheons, . . . " 905	Push Buttons, . . . . . " 896
Flush Sash Lifts, . . . . . " 916*	Push Plates, Fig. 6, . . . " 923
Hook Sash Lifts, . . . . . " †	Shutter Knobs, . . . . . " 940
Extension Bolts, . . . . . " 894*	Key Plates, . . . . . " 954

Appropriate Finish: Iron (FX80) Mult'r .52

**FIRENZE**—Fig. 10, page 422, . . . . . 31 pieces, including

Esc'n Plates and Knobs, . . . p. 422	Lever Handles, . . . . . p. 879
Cup Escutcheons, . . . " 905	Door Pulls, . . . . . " 825
Cylinder Faces, Fig. 9, " 924	Push Buttons, . . . . . " 896
Flush Sash Lifts, Fig. 1, " 916	Push Plates, . . . . . " 923*
Bar Sash Lifts, . . . . . " †	Shutter Knobs, . . . . . " 940
Letter Drop Plates, . . . " 917*	Cabinet Trim, . . . . . " 968
Extension Bolts, Fig. 3, " 894	

Appropriate Finishes: Brass (AY22) Mult'r 2.2; Copper (CY22) Mult'r .2;  
 Silver (SX52) Mult'r 2.9, (SY55) Mult'r 3.7; Gold (GZ10) Mult'r 11.; Iron  
 (FX80) Mult'r 1.6

**GENOA**—Fig. 9, page 422, . . . . . 58 pieces, including

Esc'n Plates and Knobs, . . . p. †	Drawer Pulls, . . . . . p. 927
Store Door Handles, . . . " 751	Door Pulls, . . . . . " 825
Cup Escutcheons, . . . . . " 905	Push Buttons, . . . . . " 896
Flush Sash Lifts, . . . . . " 916*	Push Plates, Fig. 3, . . . " 923
Letter Drop Plates, . . . " 917*	

Appropriate Finishes: Bronze (BZ10) Mult'r 1.; Brass (AY22) Mult'r 1.1  
 Copper (CX22) Mult'r 1.1; Gold (GY10) Mult'r 8.4; Iron (FX80) Mult'r .75

\*A few Designs only are shown as examples. † Not illustrated.

LEGHORN—Fig. 9, page 874, . . . Door Knocker only.

LODI—Fig. 11, page 423, . . . 44 pieces, including

Esc'n Plates and Knobs, p. 423	Door Pulls, . . . . . p. 826
Store Door Handles, . . . " 753	Push Buttons, . . . . . " 896
Cup Escutcheons, . . . " 905	Push Plates, . . . . . " 923*
Flush Sash Lifts, . . . . " 916*	Shutter Knobs, . . . . . " 941
Bar Sash Lifts, . . . . . " †	Cabinet Trim, . . . . . " 971
Extension Bolts, Fig. 3, " 894	

Appropriate Finishes: Copper (CY22) Mult'r 2.2; Silver (SY52) Mult'r 2.9;  
Gold (GY10) Mult'r 11.; Iron (FX80) Mult'r 1.5

MEDICI—Fig. 12, page 423, . . . 37 pieces, including

Esc'n Plates and Knobs, p. 423	Extension Bolts, . . . . . p. 894*
Store Door Handles, . . . " 753	Door Pulls, . . . . . " 826
Cup Escutcheons, . . . " 905	Push Buttons, . . . . . " 896
Flush Sash Lifts, Fig. 12, " 916	Push Plates, . . . . . " 923*
Bar Sash Lifts, . . . . . " †	Shutter Knobs, . . . . . " 941
Letter Drop Plates, Figs. 9 and 10, . . . . . " 917	Cabinet Trim, . . . . . " 972

Appropriate Finishes: Brass (AZ15) Mult'r 2.; Copper (CX22) Mult'r 2.; Silver  
(SY52) Mult'r 2.2; Gold (GY10) Mult'r 10.5; Iron (FX20) Mult'r 1.5

MILAN—Fig. 13, page 423, . . . 48 pieces, including

Esc'n Plates and Knobs, p. 423	Push Buttons, . . . . . " 896
Store Door Handles, . . . " 753	Push Plates, . . . . . " 923*
Cup Escutcheons, . . . " 906	Hinge Straps, . . . . . " 852
Flush Sash Lifts . . . . . " 916*	Sash Sockets, . . . . . " †
Letter Drop Plates, . . . . " 917*	Shutter Knobs, . . . . . " 941
Extension Bolts, . . . . . " 894*	Cabinet Trim, . . . . . " 972
Door Pulls, . . . . . p. 827	

Appropriate Finishes: Copper (CY22) Mult'r 2.6; Silver (SX52) Mult'r 3.2;  
Gold (GZ10) Mult'r 11.5. Hand Chasing, Mult'r 1.6 additional.

MIL0—Fig. 8, page 752, S. D. Handles and Door Pulls only.

MESSINA—Fig. 22, page 875, . . . Door Knocker only.

MODENA—Fig. 21, page 875, . . . Door Knocker only.

MONACO—Fig. 13, page 594<sup>B</sup>, . . . 36 pieces, including

Esc'n Plates and Knobs, p. 594 <sup>B</sup>	Letter Drop Plates, . . . p. 917*
Store Door Handles, . . . " 760	Extension Bolts, . . . . . " 894*
Cup Escutcheons, . . . " 906	Cupboard Trim, . . . . . " †
Flush Sash Lifts, . . . . . " 916*	Door Pulls, . . . . . " 827
Hook Sash Lifts, . . . . . " †	Push Buttons, . . . . . " 896
Bar Sash Lifts, . . . . . " †	Push Plates, . . . . . " 923*
Drawer Pulls, . . . . . " 927	Key Plates, . . . . . " 955

Appropriate Finishes: Iron, Copper Plated (FCZ17) Mult'r .25, (FCX17) Mult'r  
.25; Brass Plated (FAZ17) Mult'r .25, FAX17) Mult'r .25; Iron (FX80) Mult'r .6

\*A few Designs only are shown as examples. †Not illustrated.

**ALERMO**—Fig. 14, page 423, . . . . . 38 pieces, including

Esc'n Plates and Knobs, . . . . . p. 423	Door Pulls, . . . . . p. 827
Cup Escutcheons, . . . . . " 906	Push Plates, . . . . . " 923*
Flush Sash Lifts, . . . . . " 916*	Shutter Knobs, . . . . . " 941
Lever Handles, . . . . . " 879	Drawer Pulls, . . . . . " 927

Appropriate Finishes: Copper (CX22) Mult'r 3.; Silver (SX52) Mult'r 3.7; Gold (GX12) Mult'r 11.8; Iron (FX80) Mult'r 1.8; Hand Chasing, Mult'r 1.6 additional.

**ASCO**—Figs. 5 and 10, page 594A, . . . . . 31 pieces, including

Esc'n Plates and Knobs, . . . . . p. 594A	Letter Drop Plates, . . . . . p. 917*
Store Door Handles, . . . . . " †	Door Pulls, . . . . . " 827
Cup Escutcheons, . . . . . " 906	Push Buttons, . . . . . " 897
Flush Sash Lifts, . . . . . " 916*	Push Plates, . . . . . " 923*
Hook Sash Lifts, . . . . . " †	Cabinet Trim, . . . . . " 972A

Appropriate Finishes: Brass Plated (FAX17) Mult'r .25; Copper Plated (FCX17) Mult'r .25; Iron (FX80) Mult'r .6

**EGGIO**—Page 873, . . . . . Door Knocker only.

**UALTO**—Fig. 16, page 423, . . . . . 10 pieces, including

Esc'n Plate and Knobs, . . . . . p. 423	Door Pulls, . . . . . p. 828
Flush Sash Lifts, . . . . . " 916*	Push Plates, . . . . . " 923*
Hook Sash Lifts, . . . . . " †	Kick Plates, . . . . . " 870*
Extension Bolts, . . . . . " 894*	Corner Plates, . . . . . " 853
Flush Bolts, . . . . . " †	

Appropriate Finishes: (Copper CX22) Mult'r 2.8; Brass (AX61) 3.5; Silver (SX52) Mult'r 3.5

**IVOLI**—Fig. 5, page 754, . . . . . 4 pieces, including

Store Door Handles, . . . . . p. 755	Push Buttons, . . . . . p. 897
Door Pulls, . . . . . " 828	Push Plates, . . . . . " 923*

Appropriate Finishes: Copper (CX22) Mult'r 4.6; Silver (SX52) Mult'r 5.6; Iron (FX80) Mult'r 3.25

**AVONA**—Page 972B . . . . . Cabinet Trim only

**BIENA**—Fig. 15, page 423, . . . . . 20 pieces, including

Esc'n Plates and Knobs, . . . . . p. 423	Push Buttons, . . . . . p. 897
Store Door Handles, . . . . . " 757	Push Plates, . . . . . " 923*
Door Pulls, . . . . . " 829	

Appropriate Finishes: Copper (CX22) Mult'r 2.4; Bronze (BY65) Mult'r 2.4; Silver (SX52) Mult'r 3.25, (SY55) Mult'r 4.3

**ARANTO**—Fig. 23, page 875, . . . . . Door Knocker only.

**ERNI**—Fig. 5, page 874, . . . . . Door Knocker only.

**IVOLI**—Fig. 15, page 875, . . . . . Door Knocker only.

\*A few Designs only are shown as examples. †Not illustrated.

## TOSCA—Fig. 17, page 423, . . . . . 31 pieces, including

Esc'n Plates and Knobs, . . . p. †	Door Pulls, . . . . . p. 829
Cup Escutcheons, . . . " 906	Push Buttons, . . . . . " 897
Store Door Handles, . . . " 757	Push Plates, . . . . . " 923*
Cylinder Faces, Fig. 1, . . . " 924	Key Plates, . . . . . " 965
Flush Sash Lifts, . . . . . " 916*	

Appropriate Finishes: Copper (CY22) Mult'r 2.25; Silver (SY52) Mult'r 2.9;  
Gold (GY12) Mult'r 9.5; Iron (FX80) Mult'r 1.7

## TREVISO—Fig. 18, page 423, . . . . . 32 pieces, including

Esc'n Plates and Knobs, . . . p. 423	Push Buttons, . . . . . p. 897
Store Door Handles, . . . " 757	Push Plates, . . . . . " 923*
Cup Escutcheons, . . . " 906	Hinge Plates, . . . . . " 855
Flush Sash Lifts, Fig. 6, . . . " 916	Shutter Knobs, . . . . . " 941
Door Pulls, . . . . . " 829	

Appropriate Finishes: Copper (CY22) Mult'r 4.5; Silver (SY52) Mult'r 5.1;  
Gold (GY10) Mult'r 13.; Iron (FX80) Mult'r 3.2; Hand Chasing, Mult'r 2.5  
additional.

## TURIN—Fig. 14, page 875, . . . . . Door Knocker only.

## URBINO—Fig. 19, page 423, . . . . . 69 pieces, including

Esc'n Plates and Knobs, . . . p. 423	Bell Pulls, . . . . . †
Store Door Handles, . . . " 757	Push Buttons, . . . . . " 897
Cup Escutcheons, . . . " 906	Push Plates, . . . . . " 923
Flush Sash Lifts, . . . . . " 916*	Hinge Plates, . . . . . " 855
Letter Drop Plates, . . . . . " 917*	Sash Sockets, . . . . . †
Extension Bolts, . . . . . " 894*	Shutter Knobs, . . . . . " 941
Door Pulls, . . . . . " 829	Cabinet Trim, . . . . . " 972†

Appropriate Finishes: Copper (CX22) Mult'r 2.; Silver (SX52) Mult'r 2.8;  
Gold (GX10) Mult'r 11.; Iron (FX80) Mult'r 1.4

\* A few Designs only are shown as examples. † Not illustrated

# Francis I.

born at Cognac, 1494, died at Rambouillet, 1547. Imprisoned by Charles V. of Spain, 1525-1526. Grolier, the Bibliophile, was treasurer under Francis I, and designed and supervised many of the beautiful bindings by which his name became famous. (1479-1565). Etienne de Laulne most famous French designer of this period.



ALOIS and Valois-Orleans (1328-1589) were the two houses which gave the glories of the Renaissance to France. Charles, the younger son of Philip the Bold, received the territory of Valois from his father and was the ancestor of the Valois kings.

Early in life Francis showed a remarkable fondness for the fine arts, and chiefly to his later efforts to gratify it, must be attributed the great works of French Renaissance. He was the son of Charles, Count of Angouleme, and became king in 1515.

France was then a fallow field and the influence of the famous Italians whom Francis attracted by his patronage was quickly felt. The works at Chambord, Amboise, Blois, Azay-le-Rideau, Chenonceau, Fontainebleau and other sites are examples of the vigorous and fruitful growth from such sowing. It is therefore natural that the ornament of this period savors strongly of the Italian Renaissance, full of grace, vigor and beauty so characteristic of that school. There is, however, a quality in it, which, whether it came from the efforts of Francis himself and his French



Medallion in private collection at Troyes.





Entrance Doorway.

architects, Dubreuil, Sanson, le Breton, de Chambiges and others to stamp it as French, or from the influence exerted by their constant association with French ornament, marks it as a distinct departure, in fact a new school. Certain characteristics of this school are easily recognized. Paneled pilasters intersected by the rosette or diamond, the use of a pattern as the background or enrichment of a surface, perforated carved tracery in railings and walls suggested possible by a similar disposition in Gothic



Medallion,  
Amiens Cathedral.

art, irregular quoins at corners, the shell, the salamander (Francis' own symbol) delicate arabesques in panels, cherubs' heads and children and Satyrs, the S form of console used as a bracket without solid backing, are all characteristic. The effect of perforated ornament was carefully studied, and it was used most lavishly in the volutes of capitals and in balustrades and openings, thus obtaining deep rich relief and considerable delicacy. Both in design and execution the carvings of this school are the works of a robust and refined art imported though it was. There is a gaiety about it, a vigor and go that mark it as the work of enthusiasts. Such Francis was and such were those, whose genius so fascinated him, Leonardo, Primaticcio, Cellini, del Abbate, Serlio, Vignola, Il Rosso, and others to whom his purse and heart were opened. During the reign of Francis and through the influence of the artists of the Fontainebleau school the cartouche as a decoration received much attention, and was extensively used during the whole of the Fifteenth or Sixteenth century. It is said that it had its origin in the leather scrolls or placards placed outside the respective owners' tents or marquees, or on trees or other supports at tournaments. These placards curling on the edges under the influence of the sun and rain gave a hint which designers were quick to take.



Panel, Cathedral at Limoges.

Another story has it that in



Fireplace, Chateau de Blois.

the freely curled edges we only see a degenerate form of the Ionic volute and the latter Mr. Goodyear attributes to the lotus through Egyptian and Greek modifications.

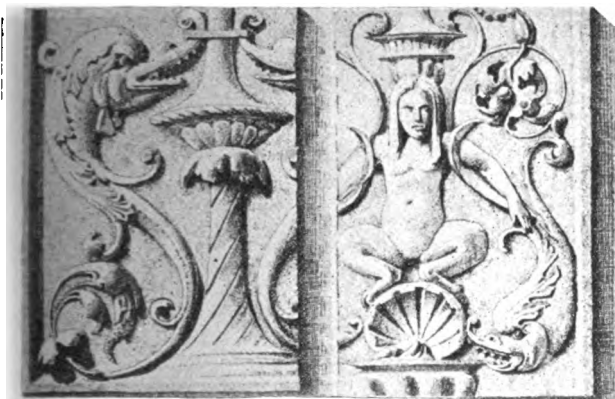

Arabesques, Chateau de Blois. Collection of Mr. Morand.

Francis built at Moret near Fontainebleau a hunting lodge in 1523, a gem of the period. This was moved and set up in Paris in 1826, and is well known to students. The medallions on this facade are attributed to Jean Goujon.

In the autobiography of Benvenuto Cellini the character of

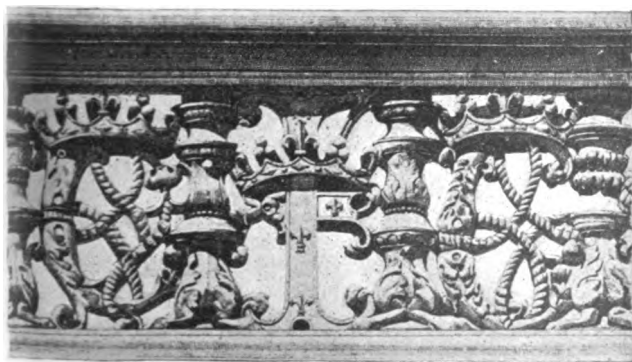

Balustrade of Great Staircase, Chateau de Blois.

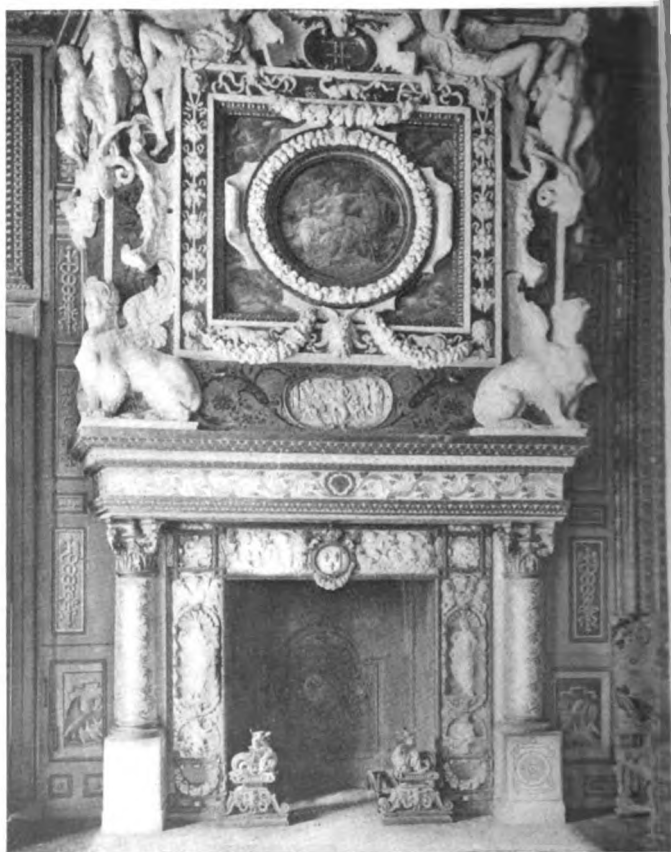

Fireplace at Fontainebleau.

Francis is well portrayed and the encouragement which he lavished on all the arts is exemplified in his orders to and his dealings with Cellini.

Few kings have had the privilege of encouraging such an



Ceiling Medallion.  
Staircase, Chateau Azay-le-Rideau.

artist and few artists have known such kingly encouragement. The effect upon French art was far reaching, and the world of arts and letters soon forgave Francis I his sins of omission for what he did for France and mankind in general, in the ennoblement of the individual artist and artisan.

As in all such times, the effect of the improvement in architecture spread through all the arts and sciences, and even furniture and utensils of daily life soon showed the individual inspiration and skill which the royal master so much loved to discover.

A most charming bit of architecture embellished with exquisite medallions heads and Latin mottoes is the Tour des Gensdarmes and its wall and brother tower at Caen, built evidently just previously to the reign of Francis, during the rule of Louis XII. It is strongly imbued with the spirit of this period and shows how even a rich man's amusement may, when done with appre-





Medallion at Blois.

ciation, become the means of pleasure and positive instruction to the public. It consists now of only two towers connected by a garden wall. But such a wall and such towers. They stamp their creator as at least a patron of talent, if not himself a connoisseur, although living in such times he probably also was the latter. Originally there was a dwelling

or villa surrounded by the walls which extended about its rear in a curve forming in their entirety a little more than a semi-circle with four towers, the other two being directly back of the present ones and forming also parts of the walls. But however charming the plan, the ornament is the attractive portion of the design to-day, and few architectural medallions are more charming than those built into the tower and the crenellations of the wall.

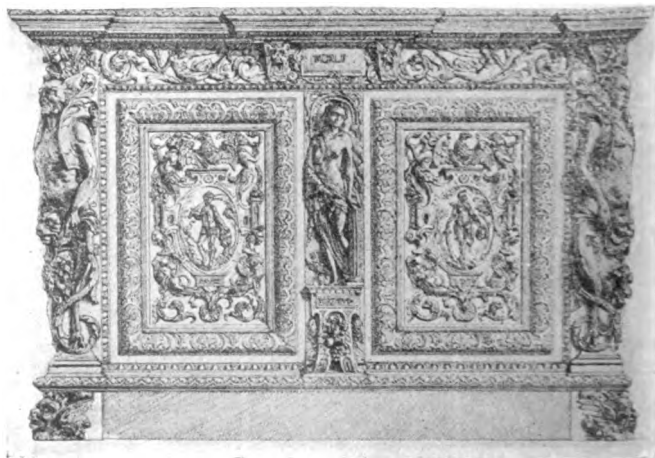

Front of Wooden Chest.

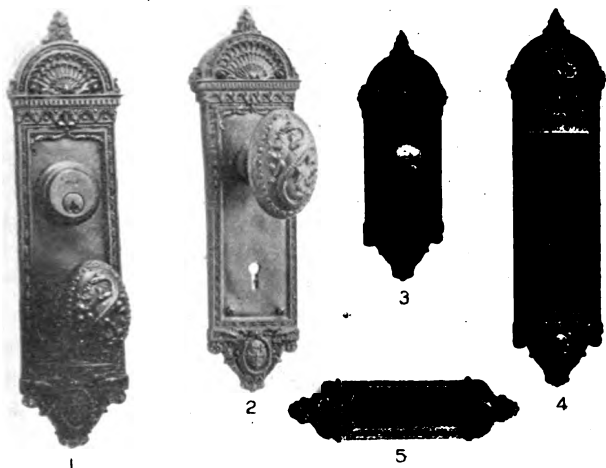

Yale & Towne Designs.

Francis I.

The Multipliers indicate the relative prices of the various finishes, as compared with prices of corresponding pieces in the Cluny Design, Copper Finish (CX22), pages 734 and 735. For Explanation of Multipliers see page 34. For Explanation of Finish Symbols see page 609.

CHAMBORD—Figs. 1 to 5, above, . . . 38 pieces, including

Esc'n Plates & Knobs, p. 437	Push Buttons, . . . p. 895
Cup Escutcheons, . . . " 904	Push Plates, . . . " 923*
Flush Sash Lifts, . . . " 916*	Shutter Knobs, . . . " 940
Appropriate Finishes: Copper (CY22) Mult'r 3.7; Brass (AZ15) Mult'r 3.7; Silver (SX52) Mult'r 4.3, (SY55) Mult'r 5.; Gold (GY10) Mult'r 12.7	

\*A few Designs only are shown as examples.





Mirror in Carved Wood.

## Henry II.

Born 1519, died 1559. Goujon, de l'Orme, Bullant, Pilon, Lescot.



SON of Francis I, Henry II was King of France from 1547 to 1559. Catharine de Medici became his wife in 1531. Upon designs of this period the attributes of Diana of Poitiers, his mistress, occur, together with the king's monogram and the royal coat of arms. The crescents are attributes of Diana the goddess, and in this triple intertwining, of her of Poitiers, while D and H are often intertwined in the familiar monogram of Diana and Henry.

The cartouche in this school is often used in a formal manner, while the foliage, and in fact all other ornament has, at times, a hard and classic character rather than any great delicacy. It seems to be generally in excellent scale, one piece in good proportion to another.

Trophies, weapons, masques, fruit, ribbons are arranged cleverly to cover the panel spaces, and the interlace in many places is introduced with the male and female torso. Beautiful



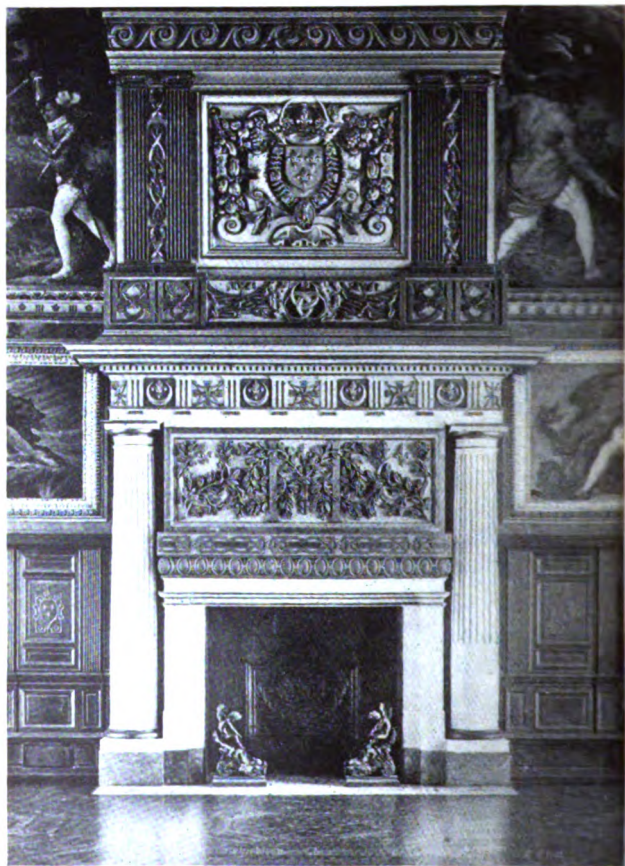

Mantel at End of Gallery of Henry II, Fontainebleau.

interlaced borders are found on the pages of books of this time, and the embroideries on stuffs are of a rich and elegant character.

Jean Goujon, Philibert de l'Orme, Jean Bullant, Germain

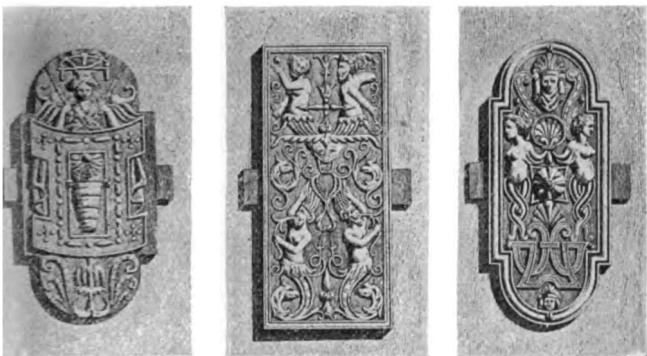

Wrought Iron Bolts from Various Sources.

lon and Pierre Lescot are names which show that the arts flourished in these days in spite of the religious feuds which led to the Massacre of St. Bartholomew. Goujon became famous by his nymphs on the Fontaine des Innocentes and other rural carvings, his work on the Louvre and by the staircase of Henry II in the Louvre. He also worked on the chateau at

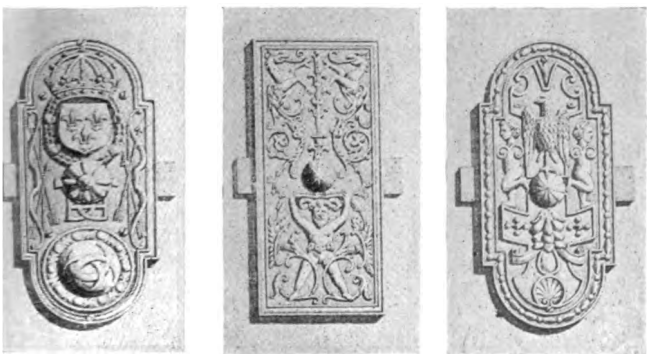

Wrought Iron Bolts from Various Sources.



Mantel in Dining Hall, Chateau of Anet.

Anet under de l'Orme, who was Court Architect, and made Anet rather French than Italian to please Diana who opposed

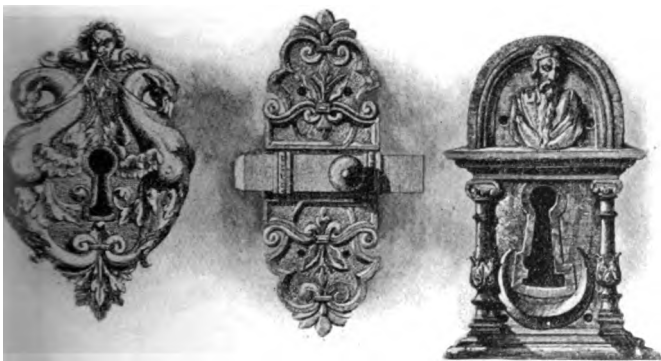

Hardware from Different Sources.

the Italian taste of Catharine. It is to Goujon, however, that we owe much of the best sculpture both in figures and ornament. His composition is excellent and in conventionalization he is always a master to study. The carvings at the Cha-

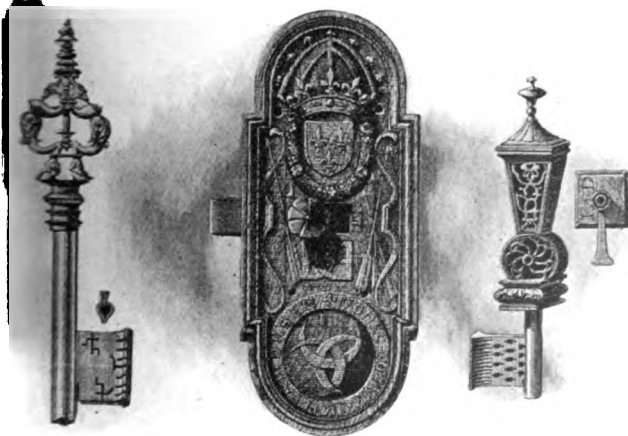

Hardware from Different Sources.



Carved Wooden Panel—Collection of M. Bonaffe.



teau d' Ecoeuen and at the Hotel Carnavalet give evidence of his great talent.

It is said that only in the chateau of Anet which runs the gamut of the style of Henry II, the residence of Diana of Poitiers, did Henry show the monogram of D and H. Elsewhere it was C and H.

This is a very fruitful period and brings out emphatically the peculiar and national characteristics of the French designers, as opposed to the Italians who com-

Urn Containing the Heart of Francis I.

peted constantly for Court favor. It is a style which deserves much study on account of the excellence of its composition, and the proportions of the units which make up the masses.

The work of Bernard Pallissy during these disturbed years was of great importance to art, and the single example given shows how carefully the detail of even ordinary household objects was studied and how beautiful



Ceramic Candlestick, School of Pallissy.





Capital by de l'Orme at the Tuileries.

display have in no school been more frequently shown, and, in fact, the French Renaissance reached under Henry II its highest plane.

they were made. In this particular piece the interlace is most effectively employed.

Ceramics of this period are rare and valued highly by collectors, some pieces bringing great prices.

It is seldom one finds more interesting examples of design in metal than the iron masques and bolts given on the first few pages of this article. Evidences of great taste and lavish

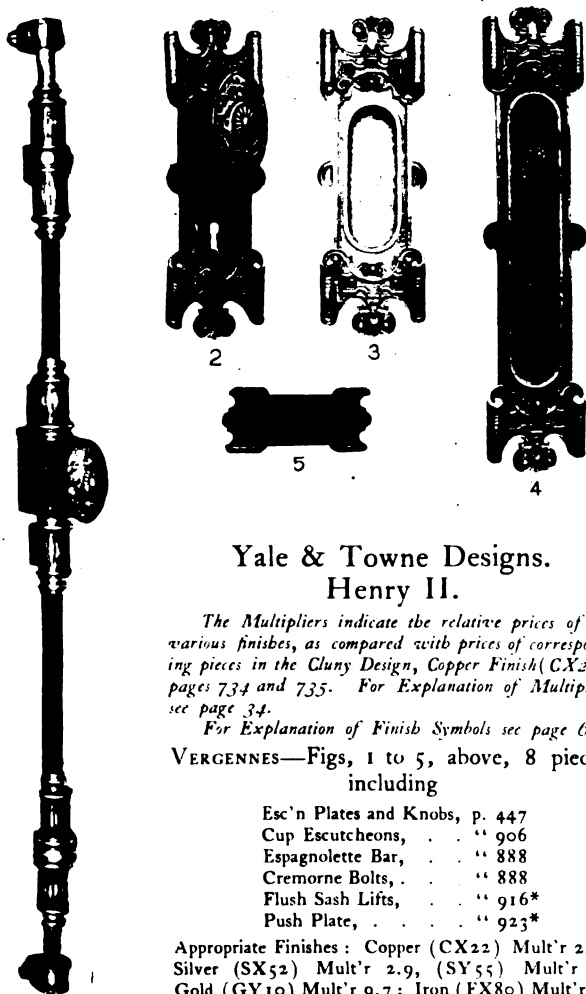

### Yale & Towne Designs. Henry II.

The Multipliers indicate the relative prices of the various finishes, as compared with prices of corresponding pieces in the Cluny Design, Copper Finish (CX22), pages 734 and 735. For Explanation of Multipliers see page 34.

For Explanation of Finish Symbols see page 609.

VERGENNES—Figs, 1 to 5, above, 8 pieces, including

Esc'n Plates and Knobs,	p. 447
Cup Escutcheons,	“ 906
Espagnolette Bar,	“ 888
Cremorne Bolts,	“ 888
Flush Sash Lifts,	“ 916*
Push Plate,	“ 923*

Appropriate Finishes : Copper (CX22) Mult'r 2.25; Silver (SX52) Mult'r 2.9, (SY55) Mult'r 3.6 Gold (GY10) Mult'r 9.7; Iron (FX80) Mult'r 1.6

\* A few Designs only are shown as examples.

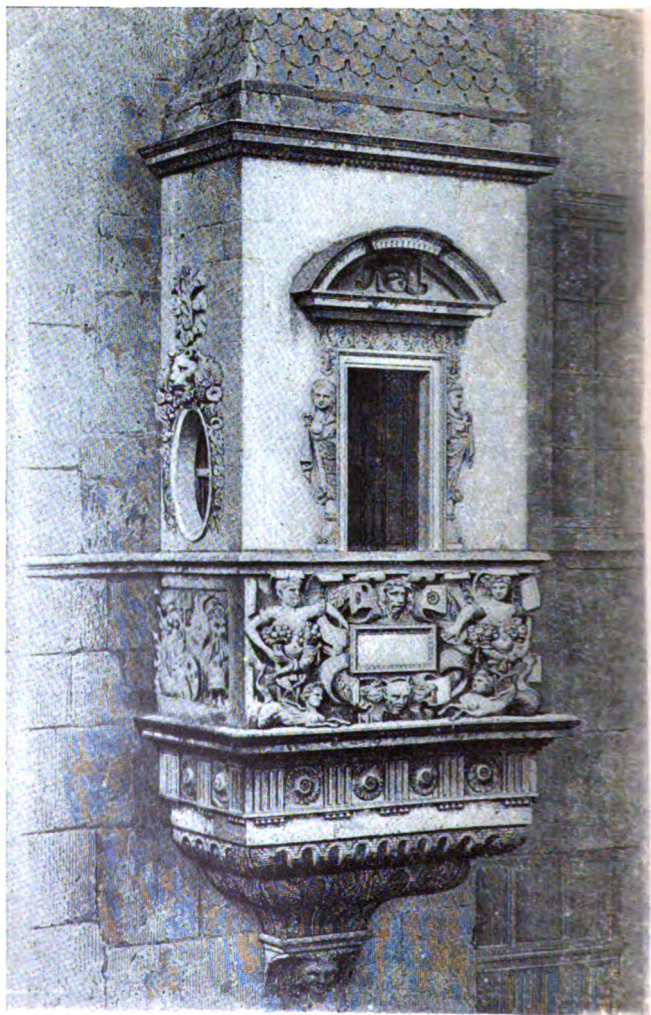

Oriel, Rue de la Vannerie, at Dijon.

## Henry III.

Born at Fontainebleau 1551, died at St. Cloud 1589, Goujon, Du Cerceau.  
François Briot.



ALTHOUGH son of Catharine de Medici and Henry II, Henry III would hardly seem to have been able to give personal encouragement to the arts in such troubled times. The style during his reign 1574-89 is, however, indicative that knowledge of ornament and decoration had not departed with the death of the father. He was the last of his branch of the Valois kings.

Jean Goujon's influence is still apparent in the masques of the Pont-Neuf and in other pieces done in his manner though not always by him. Jacques Androuet Du Cerceau, although the equal of Goujon in neither taste nor execution, nevertheless left interesting examples of his work in the reign of Henry III. He frequently introduced human and allegorical figures, roses, birds, grotesques and arabesques. In a Book of Friezes collected by Jombert, numerous good examples of this master's talent may be found. His ornament is rich, but at times overbalanced by its ponderous griffins and its rather gross and exceedingly muscular male genii. Masques with varying designs of crowns over the foreheads



Bed by Du Cerceau.

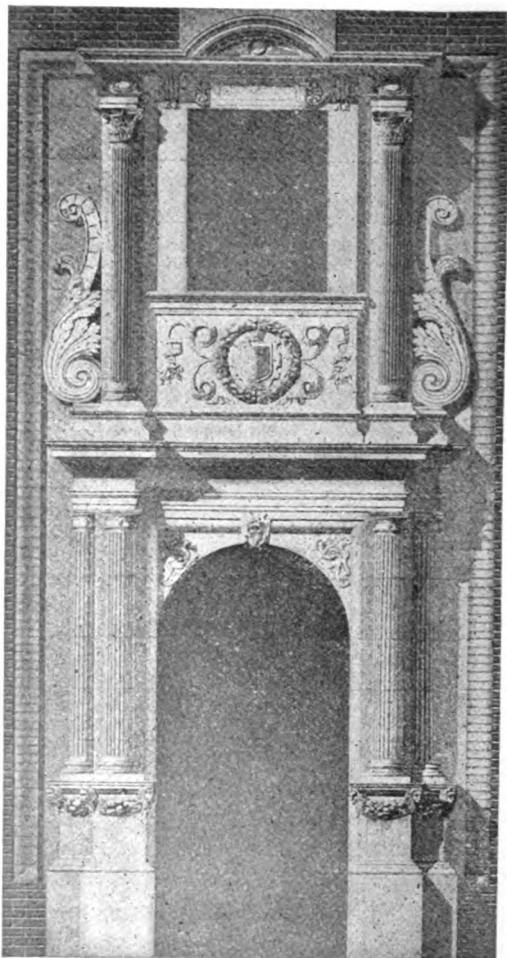

Door and Window at Toulouse.

distinguish the work of the reigns of the Henrys should refer to

are presented in various and foliated attenuated the inter are heavy which gives a peculiar contrast that is characteristic of the style. Du Cerceau also worked during the reign of Charles IX.

There was more interesting work than Du Cerceau's done during this time, of which the accompanying arabesques give a hint.

One who wishes to



Frieze by Du Cerceau.

special works on the different periods. Even then it is difficult in each case to name the exact date of the ornament, the end of one period closely approaching in character the beginning of the next, as in all schools.

Certain arabesques of this school are most effective both in their composition and the scale of the ornament. The panel is well filled, and the ornament, while rich, is so varied as not to tire the eye. It is, perhaps, asking too much of the student to try to emphasize this period of Henry III as producing a decided school in style; but while no great originality is shown, the skill with which ornament is handled and the traditions thereof handed down, would seem to make it imperative that the chain should not be broken by the omission of the age of Henry III from these articles.

Here, for instance, are four arabesques, and while the work



Frieze by Du Cerceau.

is heavy and not an improvement upon the Italian art, which evidently inspired it, yet the concavity of the carouches is charmingly used to set off the quaint figures intermingled with them, and the masques, fruit and flowers and grotesques are certainly done by no bungling hand.

The effect sought is obtained; this is apparent at a glance, and a high plane of decoration is attained by very simple means, which fact argues talent of a considerable degree.

Du Cerceau's tables and other furniture show decided appreciation of the value of ornament, and pave the way for those later masters of French carving, who eclectically drawing from not only these but other sources, such as the work



Carved Wooden Panel.



Carved Wooden Panel.

of the peasants, have left examples of design in the collections of Europe full of rich significance, telling most pointedly what a man can do with a chisel and talent. The French are the legitimate heirs of the Italian Renaissance, and that the inheritance fell into worthy hands nothing tells better than the work of the lesser masters in carving in wood and stone. Where can be found more beautiful examples of ornament than are seen on the historic buildings of France and on the exquisite tables, chairs, coffers and cabinets with which these buildings were usually furnished. Into the designs of mantels especially, the French designer seemed to put his best thought, and they are excelled by the Italians alone, in the



Carved Wooden Panel.



Carved Wooden Panel.





Carved Wooden Panel. Henry III as King of Poland.

magnificent results so familiar to the student of the interior architecture of dwelling, chateau or public building from the XV<sup>th</sup>



Table, Du Cerceau.

to the XVIIIth Century. Perhaps no collection gives a better idea of all this than the Cluny Museum in Paris. There may be traced the rise of Renaissance art from mediæval times to its degeneracy, and in the most interesting way through the excellence of the examples exhibited.

François Briot, about the date of whose birth there is some confusion, probably worked in this period. He was an excellent designer in silver and gold, a goldsmith in fact, and is represented at thirty years old in a costume of the time of Henry III, according to documents in the Cluny Museum, which possesses one of the rare examples of this master.

Without study one is apt to confuse ornament of this period with that of Henry IV.



Table, Du Cerceau.

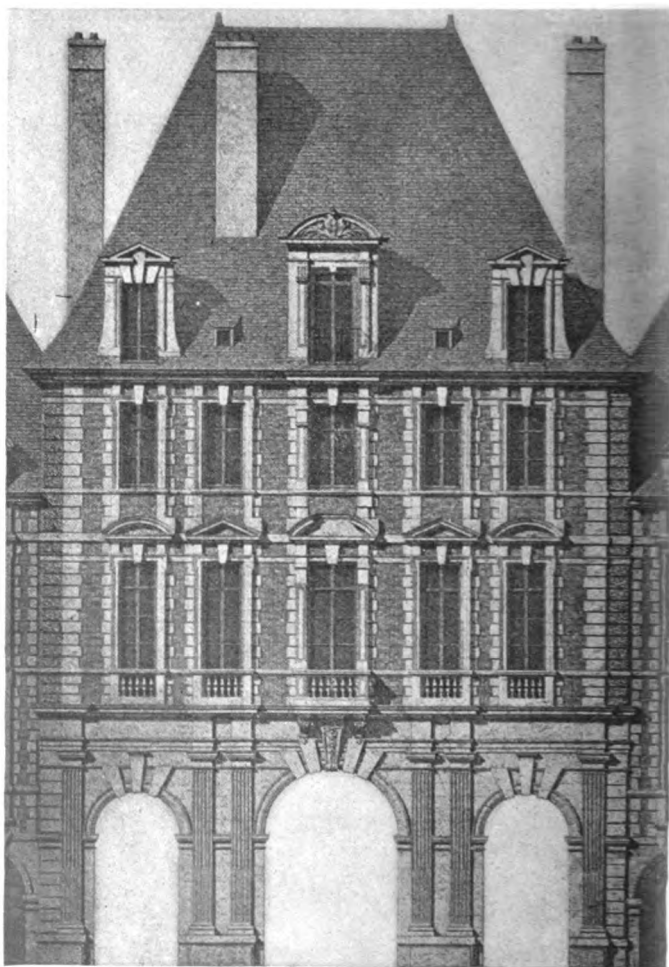

**Pavillon du Midi, Place Royale, Paris.**

## Henry IV.

Born at Pau 1553, Died at Paris 1610.

BOURBON "Henry of Navarre" reigned from 1589 to 1610, and in spite of the bloody days which came to France before and after his accession, it is not possible to see any reflection thereof in the arts of the day.

There is, however, a certain grimness and hardness in the clean cut lines of the

modeling of the interlace and in the carving of the leaf forms which sometimes have the character of work hastily or rudely done to save time or to obtain an effect of primitiveness.

The garland and encarpus of the Greek and Roman period is still to be distinguished in the vignettes, tailpieces and carvings of this date, and the human form fills many a niche and opening, while on bracket and cartouche and pediment, the grotesque greets one in the form of grinning masque and conventionalized satyr.

A free use of leaf ornament is to be seen in the columns on the stair balustrade in the church of St. Etienne-du-mont, Paris, where the general interior of the church also shows an interesting employment of the ornament of this period.

In speaking of the hardness and primitiveness evident in certain examples of this school it is not to



Carved Panel.



Vignette.

taken as an entirely derogative criticism. Many schools have qualities of this kind which, when the ornament is shown in certain places, are rather valuable than otherwise.

Some of the best decorative carving, as we all know, is rough work, and in the Elizabethan and Flemish schools the coarseness of scale in different parts is strikingly good and engages our interest before we recognize the cause. Herein much of our modern design is at fault; we see, or try to see, intricate lace-like foliage put on a facade one or two hundred feet above the street, and we can-

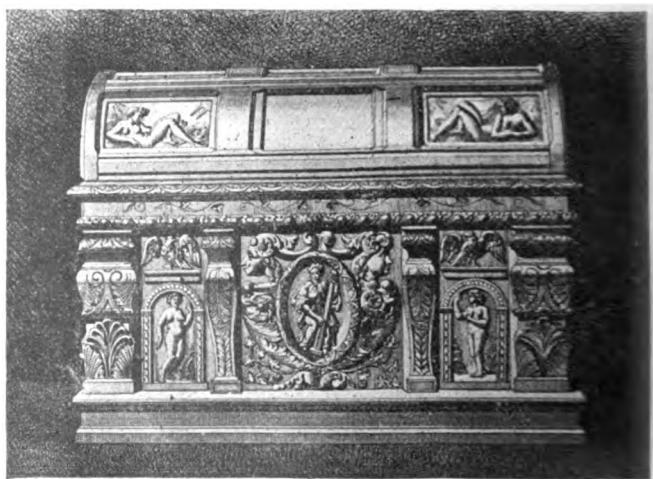



Carved Pediment.

not bring ourselves to any thought of it except that it is there and was, perhaps, put there because it was in terra-cotta and cheaply duplicated, or perhaps in stone because the client knew no better way to let his architect spend money.



Vignette.

Even in interiors where ornament is much nearer the eye, it is often miscalculated in its relation to the space it fills and its distance from the eye. That this is often the case is proved by the fact that few educated people are displeased with the coarseness of scale in Elizabethan ornament, which is characteristically bold and at times coarse. The beautiful staircase of the Cluny Museum is of the style of Henry IV.

That delicate and refined designs were also designed in this period is shown by the vignettes here given.



Panel Ornament.



## German Renaissance.

Maximilian I, 1493-1519. Durer, Holbein, Hans Burgmair, Cranach, Erasmus, Benedikt Von Laun, Peter Flötner, Gabriel Seidl, Jost Amman, Stimmer, Candid, de Voues, Dietterlin, Elias Holl, Rubens, Hollar, Bosse, 1500-1650.



GERMAN Renaissance is divided into Early, in which the Gothic and Romanesque influence is still manifest, Late, and Baroque, which last term is used frequently to indicate the Rococo outside of France.

It is a question whether on the whole the Renaissance found such interpretation at the hands of German designers as to entitle their work to a high place in the history of art. It cannot be denied that during the best years of its development there was excellent and interesting work done, but the nameless, unclassifiable horrors of its decadence are not yet forgotten, and when we see what beauty Gothic ornament had taken on, not only in palace but in cottage also, one is apt to question whether the injury of the Renaissance was not greater than its benefits to German art. Certainly the German Renaissance had a most disastrous effect on art in the United States and we have not yet freed ourselves from its decadent spirit.

However, it is more profitable to praise the good in any school than to search for the bad, and instructive and interesting examples of German Re-



Silver-gilt Candlestick.  
Late XVI Century.





Ceramic Bottle.

Germany, by the carvings on the churches and other Romanesque and Gothic buildings, on tapestries and stuffs from the Orient, etc.

Take also any examples of Gothic chest and cabinet and you will see what vigorous, imaginative qualities the designs possess. Perhaps it was impossible to develop Gothic or Romanesque ornament beyond the

naissance are numerous. Had Germany followed the spirit which had already declared itself in the Romanesque and Gothic woodwork of the peasant woodworkers preceding the Renaissance, her ornament would not now be in competition with, but excelling that of many other countries. This spirit is seen also in France in the Normandy and Brittany chests and other pieces of woodwork and is prompted, as it probably was in



Goldsmith's Hammer.

bounds reached before the Renaissance came in, but inasmuch as there is to-day in Germany a slight reaction and return to certain Gothic traditions in design, it seems as if the Renaissance had buried this spirit for years only to see it revive again.

It seems also as if the best ornament of the German Renaissance aimed at what was better expressed by Elizabethan and Jacobean ornament, and whatever the debt which these styles owe to German influence, it is probable that had the latter never been developed the English schools would have suffered little. The Flemish, Elizabethan and German Renaissance employ the same motifs for certain effects, among which are the min-

Table-knife.  
From engraving  
by Sadeler.

ute arch and pilaster in wainscoting with strap work emphasized by bosses, scallop shells galore, the jig-saw in constant evidence, and good turnings, but not equaling the Spanish and French. The Germans have used with great appreciation the grotesque, and in satyr and griffin and masque there is often revealed so much power



Silver Hanging Clock,  
Late Renaissance.



Door Knocker.

of expression as to make us regret that the early Teutonic symbolism expressed in the rough representation of monsters and elves, etc., on their wrought iron, was not developed into a national style.

Hans Holbein and Albert Durer did indeed exhibit most thoroughly this national tendency, and the world has ever since recognized the master's hand in all their work, but in spite of their numerous disciples the real significance of their art in this direction was lost before it had its due effect on German ornament. Wagner has preserved the mysticism and spirit of it in the music of his *Nibelungen Ring*,



Chairs Showing Italian Influence.

and German literature shows constant traces of it in Fairy Tales and Folk-lore, and in such ballads and poems as the Erl King, but architecture and painting to a great degree are free from the vein except in those modern carved grotesques which bear little or no resemblance to their mediæval forebears.

Possibly the new art movement of which a later article treats more fully, may be in German art the beginning of a strong and virile style, which shall save the Fatherland from its



Tyrolese Hanging Candelabrum in the Rathhaus at Sterzing.



Chair, Late XVI Century, Royal National Museum, Munich.



Wine Cabinet, Castle Rosenberg on the Moldau.

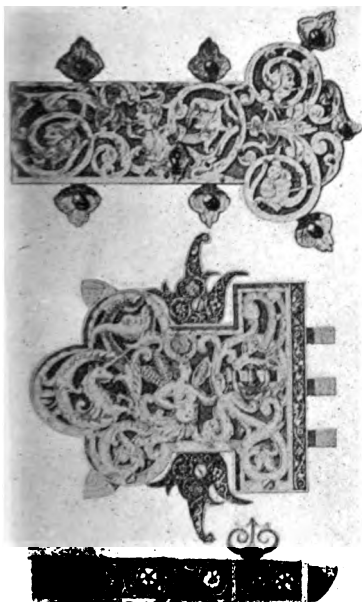

Door Lock, Late Renaissance.

modern tendencies pursued to their logical end. Certainly there is the germ of a strong design in the best of the examples of the new style, and if it is cultivated it will develop beautifully if the right men take it up, but if in the hands of mere exploiters it will become a growth more rank than that which Germany has already seen. If it only approaches in strength and quality the early Tyrolese and Swiss art, it will surely bear good fruit. Indeed it is almost a certainty that improvement in German art must come from without. The effect of the Renaissance seems to have been paralyzing to all new inspiration. There is no real national flavor to modern German design, and moreover there seems to be no spirit in the people, which promises any Teutonic art for the future. Uninspired classic repetition is all we can look for unless some great outside school arises, as did the Renaissance and the Rococo, and lead Germany out of the present maze wherein she hopelessly wanders. Of course the best that could happen would be to have an independent and vigorous Teutonic school arise, and this we hope may come.



1



2



3



4

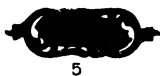

5



6



7



8



9



10



11



12

School—German Renaissance.

## Yale &amp; Towne Designs. German Renaissance.

The Multipliers indicate the relative prices of the various Designs and finishes, as compared with prices of corresponding pieces in the Cluny Design, Copper Finish (CX22), pages 734 and 735. For Explanation of Multipliers see page 34.

For Explanation of Finish Symbols see page 609.

## Bonn—Figs. 1 and 2, page 468, . 58 pieces, including

Esc'n Plates and Knobs, p. 468	Door Pulls, . . p. 824
Store Door Handles, . . " 747	Push Buttons, . . " 895
Cup Escutcheons, . . " 904	Push Plates, . . " 923*
Flush Sash Lifts, . . " 916*	Shutter Trim, . . " 922*
Letter Drop Plates, . . " 917*	Cabinet Trim, . . " 965
Appropriate Finishes: Brass (AX10) Mult'r 1.4; Copper (CX22) Mult'r 1.4; Silver (SX52) Mult'r 2.; Iron (FX80) Mult'r .85	

## DRESDEN—Figs. 3, 4 and 5, page 468, 18 pieces, including

Esc'n Plates and Knobs, p. 468	Door Pulls, . . p. 825
Store Door Handles, . . " 749	Bell Pulls, . . " †
Cup Escutcheons, . . " 905	Hinge Straps, . . " 850
Flush Sash Lifts, . . " 916*	Push Buttons, . . " 896
Extension Bolts, . . . " 894*	
Appropriate Finishes: Copper (CX22) Mult'r 2.6; Iron (FX80) Mult'r 2	

## HAMBURG—Fig. 53, page 861, . Hinge Plates only.

## HEIDELBERG—Figs. 7, 8 and 12, page 468, 13 pieces, including

Esc'n Plates and Knobs, p. 468	Push Plates, . . p. 923*
Cup Escutcheons, . . " 905	Shutter Trim, . . " 922*
Flush Sash Lifts, . . " 916*	Cabinet Trim, . . " 969
Door Pulls, . . . . " 825	
Appropriate Finishes: Copper (CY22) Mult'r 2.8; Silver (SX52) Mult'r 3.6; Gold (GY10) Mult'r 13.3; Iron (FX80) Mult'r 2	

## HONDO—Figs. 6, 9, 10 and 11, page 468, 46 pieces, including

Esc'n Plates and Knobs, p. 468	Door Pulls, . . p. 826
Store Door Handles, . . " 751	Hinge Straps, . . " 851
Cup Escutcheons, . . " 905	Push Buttons, . . " 896
Flush Sash Lifts, . . " 916*	Push Plates, . . " 923*
Hook Sash Lifts, . . . " †	Cabinet Trim, . . " 969
Letter Drop Plates, . . " 917*	

Appropriate Finishes: Bronze (BZ10) Mult'r .85; Copper (CX22) Mult'r .85; Silver (SX52) Mult'r 1.5

\* A few Designs only are shown as examples. † Not illustrated.





Entrance to Convent of San Marco at León, Spain. Plateresque Period, 1514-1549.

## Spanish Renaissance.

Grenada taken from the Moors 1492. Charles V born at Ghent, 1500, died at Yuste, Spain, 1558. Emperor of Holy Roman Empire. Pietro Perez XIII Century, de Houtanon, de Gainza, Machuca, Covarrubias, Juan de Badajos, Doucel, Berruquette, Diegode Siloe, Cespedes, de Egas, Roderigo Gil, de Segrera, Herrera.



ANKIND in literature, painting, architecture and sculpture was deeply affected by the Renaissance, but of all the races who were influenced, probably none worked with greater appreciation of its meaning than the Spanish. The fertility and refinement manifested in their interpretation of Renaissance architec-

ture are still the delight of scholars and amateurs. The Italians themselves were not more successful, and as for ornament, it was only to be expected that a nation which was half oriental in blood and tradition should rival the best that Italy had done. Certainly there is in the Spanish Renaissance a deeper vein of originality than is discovered in much of the Italian.

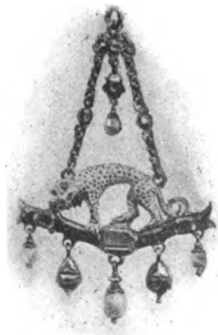

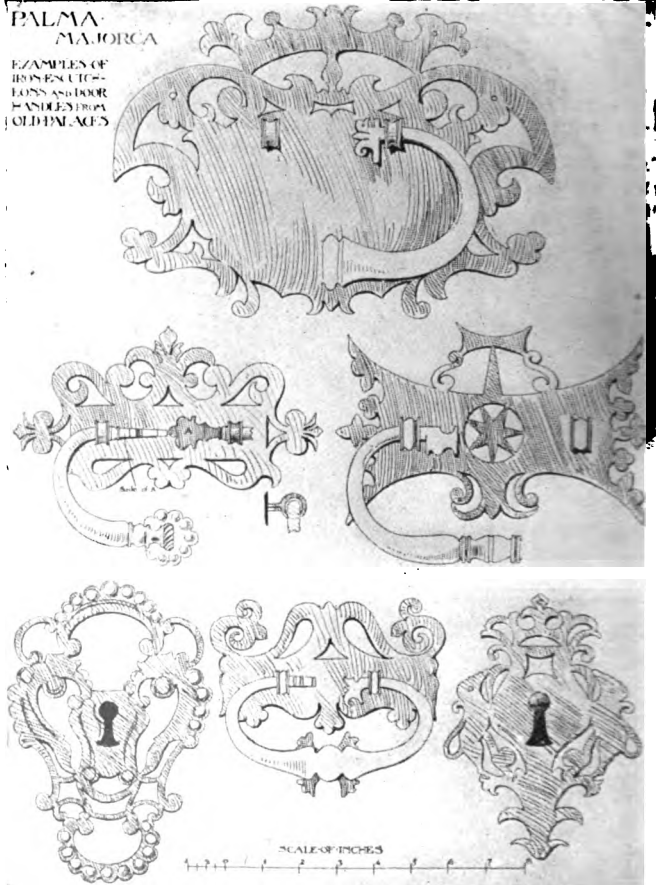

Iron Escutcheons and Handles from Old Palaces.

We might, with reason, expect that it would be almost Moorish in character as far as Italian Renaissance is Roman, yet

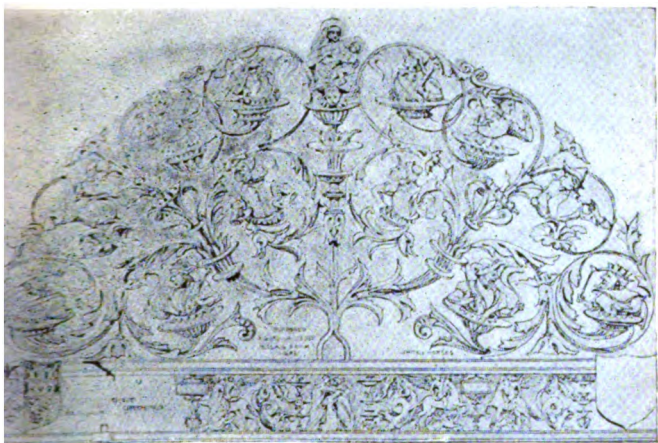

Wrought Iron Screen, Cuenca Cathedral.

It is neither strongly this nor is it Italian, but keeping the warmth of life of Eastern art, it shakes off all tendency to mere imitation of either school and becomes a style more distinct from the Italian than did that of Francis I. One reason for this might be found in the greater romanticism and creative power of the Spanish race at this period and its distance from the source of inspiration, and the consequently weaker impression received from the work of the great Italian masters. Whatever the cause, the fact remains that Spain gave the world a more living, glowing and vigorous art than the more volatile French produced, an art which left even in her colonies delightful



Pendant, XVI Century.

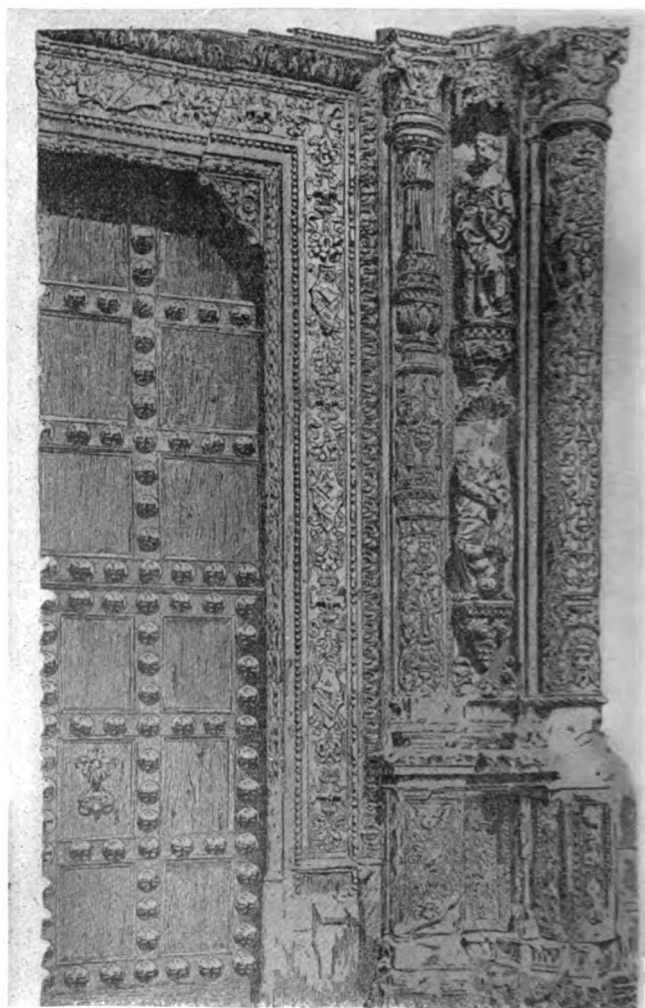

Doorway, Hospital of Santa Cruz, Toledo.

examples both of architecture and ornament, which, while founded on classic precedent, are yet not slavishly classic, but fascinating reminders of the great genius of Spanish designers of the period. In America the beauty of the style is well known, illustrated as it is by the churches and missions of Mexico and the early settlements of California, for although these may not rank among the best examples yet they show wonderful imagination, boldness and originality, all of them enduring qualities.



Pendant, XVI Century.

The characteristics of the ornament of this school are a charming liveliness and

grace in raised ornament, a frequent employment of the scallop shell, often used as a diaper pattern over a background, pinnacles or finials similar to, but more varied than the Italian, and often in turned forms. In fact the influence of the lathe is seen in many Spanish finials, balusters and grilles in stone and iron. The medallion or disc with heads in relief thereon, and deeply paneled pilasters and richly bracketed capitals, are all of frequent occurrence.

Spanish iron work is noted for the great beauty of its design and the perfection of its workmanship, the most delicate spindles flaring out in graceful contrast with the shaft in which the alternating of twisted with plain members



Silver-Gilt Wine Fountain, taken from the Admiral's ship, Spanish Armada; height 2 ft., 9 in.

gives to the entire gate or grille a varying play of lights, and a vivacity unexcelled in metal work of any age and period. As in Italian ironwork a great respect is shown for delicacy in the members of a design, and such a thing as clumsiness is rarely ever met. This is one of the best indications of keen appreciation of the laws of design, that is to know, and show that one knows, his material.



From the House of the Shells, Salamanca.



Yale & Towne Designs. Spanish Renaissance.

The Multipliers indicate the relative prices of the various finishes, as compared with prices of corresponding pieces in the Ciuny Design, Copper Finish (CY22), pages 734 and 735. For Explanation of Multipliers see page 34. For Explanation of Finish Symbols see page 609.

- ALCAZAR—Figs. 1 to 7, above, . . . . . 11 pieces, including
- |                                     |                          |
|-------------------------------------|--------------------------|
| Esc'n Plates and Knobs, p. 477      | Push Buttons, . . p. 895 |
| Cup Escutcheons, . . . 904          | Push Plates, . . . 923*  |
| Flush Sash Lifts, . . . 916, Fig. 3 | Cabinet Trim, . . . 963  |
- Appropriate Finishes : Copper (CY22) Mult'r 2. ; Silver (SX52) Mult'r 2.6 ; Gold (GY10) Mult'r 10. ; Iron (FX80) Mult'r 1.4

\*A few Designs only are shown as examples.





Flemish Interior, showing the usual richness of detail in Carved Wood.

## Flemish Renaissance.

1500-1600. The name comes from the ancient countship of Flanders, now partitioned among Holland, Belgium and France. The inhabitants were nearly allied to the Dutch in origin and speech.

Cornelius and Francis Floris, Peter Neef and other architects, painters and sculptors.



THE Renaissance was taken up in Flanders with evident delight, if we can judge of the excellent work produced there by the masters of design. There is much in it like the Elizabethan, but a greater delicacy and appreciation of refined lines and curves, emphasized by a sudden enlargement into a leaf or flower of a relief much increased over that of the stem. The result is a glittering succession of varying high lights, which at once attracts attention, and charms the eye by the wonderful skill shown in the execution. There is in the designs of Hans Holbein a pronounced Flemish quality, as also in some of the carvings of the period of Francis I. Its coarser characteristics are seen in Elizabethan cartouches and panels where the faucetted faces of round or square projections



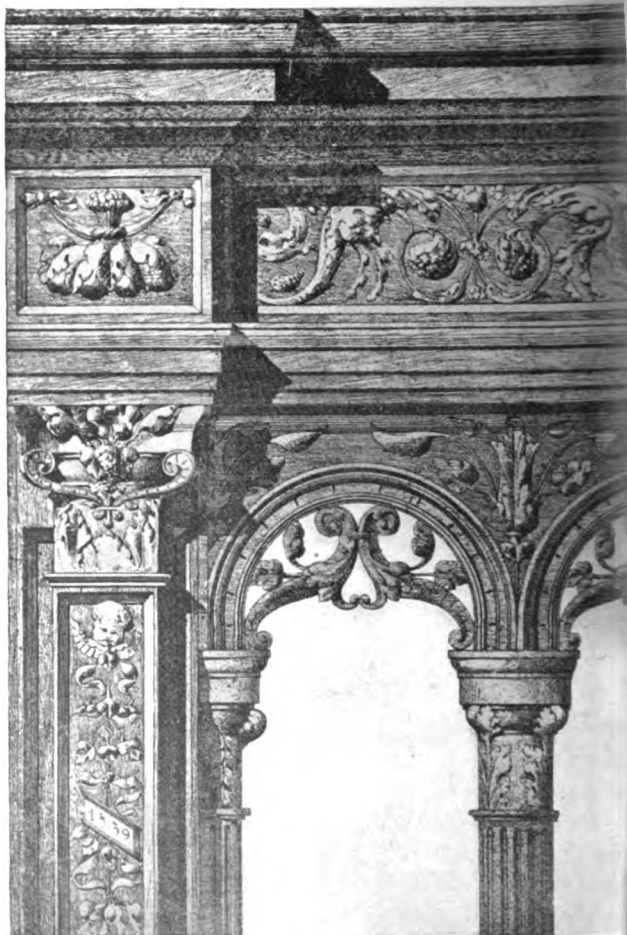

Detail of Screen, Dortrecht.

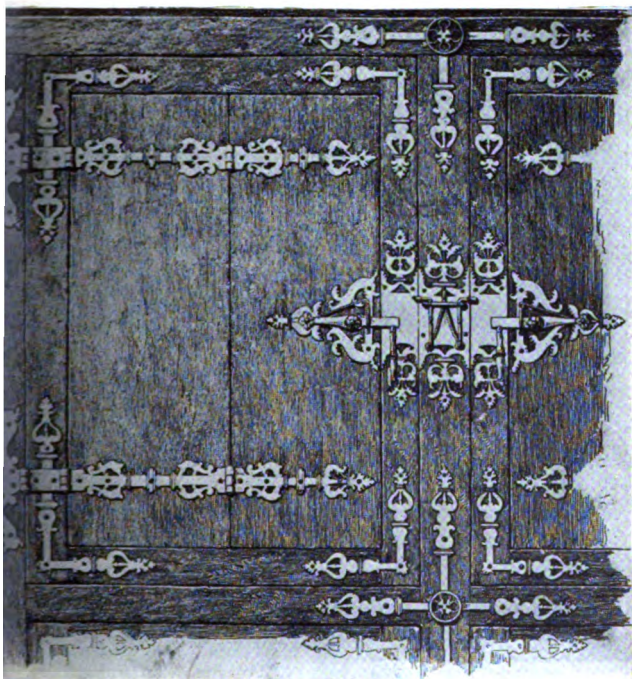

Detail of Shutters at Bruxelles.

most effectively come into play. Boldness of contrast is the quality which it most constantly preaches, and in the choice of ornament the school, like many others, is at times eclectic.

We note helmeted heads often in profile, and grotesques on console and cartouche and arabesque. Paneling is much relied upon, and upon pilasters the split colonette is applied, emphasized by bosses in various forms. Spanish art is to be likened to Flemish in the great and skillful use of the lathe everywhere apparent. Fret work, enriched with bosses and faceted forms, is

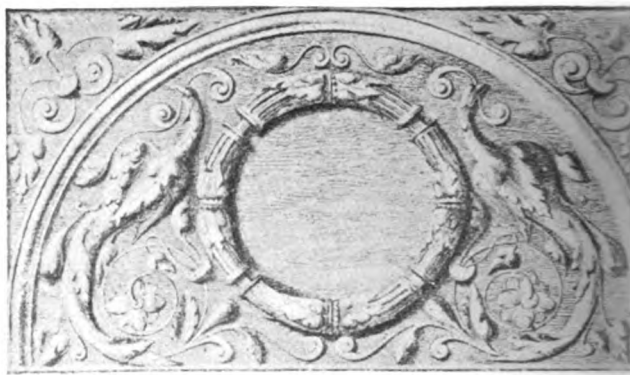

Spandrel at Kampen.

applied to the faces of plain colonettes and pilasters with carving on or accessory to it, put in such places as to command admiration rather than criticism, while the carvings themselves are full a sense of the round. In early work Gothic influence is appa



Chest at Nymque.

ent in cabinet, chair and interior woodwork most powerfully carved.

Cornelius Floris built the town hall at Antwerp in 1576, one of the best examples of Flemish, and his brother Francis, the Raphael of Flanders, designed the memorial arches upon the entry of Charles V into that city.

Flemish designers worked with an evident appreciation of the beauty of Italian art, and as we have already said, a strong Spanish influence derived through the Dutch association with Spanish rule or misrule is noticeable, the turned balusters, columns and colonettes in particular showing the abrupt and emphatic flare at frequent intervals, which is so telling in the designs of the best period in Spain. But one of the most noticeable and beautiful characteristics of Flemish carving is the delicacy and contrast



Details of Choir stalls at Dortrecht.



Details of Choir Stalls at Dortrecht.

so skillfully dwelt upon in the work of the leading craftsmen in the golden age of Flemish art. It is like Jean Goujon's work



**Spandrel at Kampen.**

on chest and coffer as we see it in Azay-le-Rideau, and in other private and public collections. It irresistibly attracts attention and commands admiration, and is a most instructive style for the wood carver to study, inasmuch as the Flemish carvers have never been surpassed in the telling brilliancy of the high lights in most of their work.



**Hercules Strangling Antaeus.  
Medallion in Wood, XVI Century.**

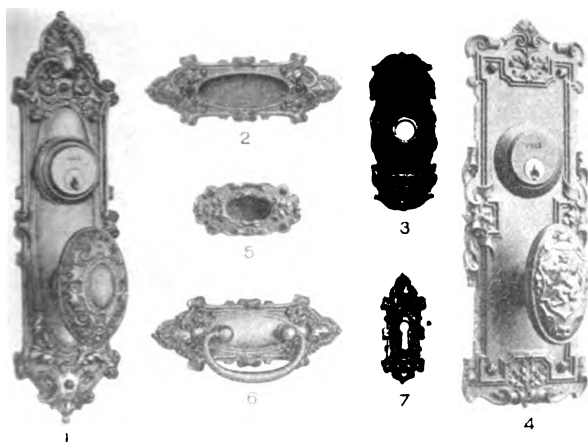

## Yale & Towne Designs. . . . Flemish.

The Multipliers indicate the relative prices of the various Designs and Finishes as compared with prices of corresponding pieces in the Cluny Design, Copper Finish (CX22), pages 734 and 735. For Explanation of Multipliers see page 34. For Explanation of Finish Symbols see page 609.

**BRABANT**—Figs. 3, 4 and 5, above, . . . 29 pieces, including  
 Esc'n Plates and Knobs, p. 485  
 Store Door Handles, . . . " 747  
 Cup Escutcheons, . . . " 904  
 Flush Sash Lifts, Fig. 7, " 916  
 Letter Drop Plates, . . . " 917\*  
 Appropriate Finishes: Copper (CX22) Mult'r 2.2; Silver (SY55) Mult'r 3.5; Green Bronze (BX67) Mult'r 2.8; Iron (FX80) Mult'r 1.5

**LARGO**—Figs. 1, 2, 6 and 7, above, . . . 71 pieces, including  
 Esc'n Plates and Knobs, p. 485  
 Store Door Handles, . . . " 759  
 Cup Escutcheons, . . . " 905  
 Flush Sash Lifts, Fig. 14, " 916  
 Extension Bolts, . . . " 894\*  
 Appropriate Finishes: Copper (CX22) Mult'r .8; Brass (AX17) Mult'r .8

\* A few Designs only are shown as examples.





Hall and Chamber, Stockton House, Wiltshire.

## Elizabethan.

Elizabeth born at Greenwich 1533, died at Richmond 1603.



THE reign of Queen Elizabeth from 1558 to 1603, followed by that of James I, was productive of a school, or rather adaptation of other schools, of ornament which, however, did not reach as high an artistic plane as did Elizabethan literature, but, nevertheless, formed a strong transitional style between Gothic and Renaissance art.

There is a great deal of flat, unmodeled, but symmetrically disposed ornament in Elizabethan woodwork. Old forms, such as the guilloche and different interlaces, and the volute and other curves are much used, connected by bands terminating in volutes and placed back to back with the frequent introduction of the boss or smaller studs.

This strap work much resembles and was influenced by that of the German and Flemish Renaissance, and many of the motives are not unlike those found in the style of Francis I, while its elaboration and richness suggest the indirect influence of Oriental ornament.

The Elizabethan style never wholly freed itself





**An Ancient House, Ipswich.**

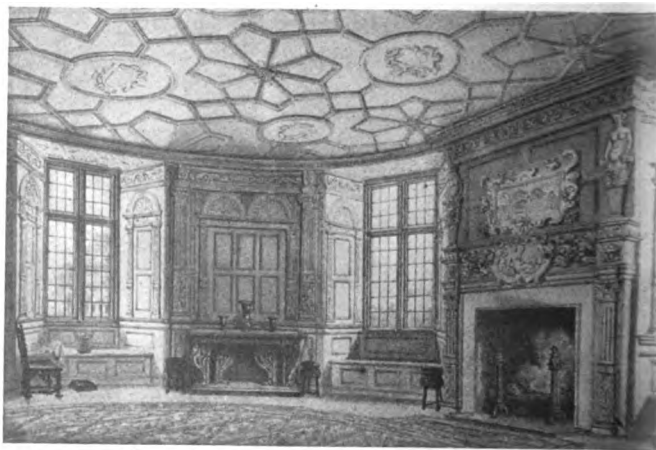

**The Circular Dining Room, Longford Castle, Wiltshire.**



Plaster Frieze, Crewe Hall, Cheshire.

from the character which was imposed on it by the preceding stages of English Gothic noticeable in certain mouldings and the occasional realism of foliage, nor can it always readily be distinguished from kindred forms in the Renaissance of the Continent, particularly German and Flemish.



Iron Tankard.

pression upon succeeding work, although to-day we, in America,



Plaster Frieze, Crewe Hall, Cheshire.



Plaster Frieze, Little Charlton.

are seeing its revival in a very healthy and constantly growing fondness for the Elizabethan country house.

Toward the close of the reign of Queen Elizabeth the stiffness and formality of style produced by the preceding Gothic had settled into the school distinctively known as Elizabethan, but it can scarcely be considered as more than a transitional stage and soon after the death of James I, English ornament, as expressed decidedly in Jacobean work, felt more strongly the powerful influence of the Italian Renaissance as the works of Inigo Jones and Sir Christopher Wren plainly indicate.



Ceiling to one of the Triangular Windows, Little Charlton.

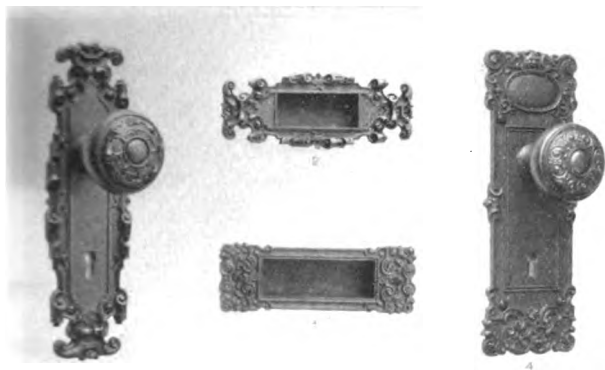

Yale & Towne Designs. . . Elizabethan

The Multipliers indicate the relative prices of the various Designs and Finishes as compared with prices of corresponding pieces in the Cluny Design, Copper Finish (CX22), pages 734 and 735. For Explanation of Multipliers see page 34.

For Explanation of Finish Symbols see page 609.

LEICESTER—Fig. 33, page 859, . . . Hinge Plates only.

RALEIGH—Figs. 1 and 2, above, . . . 14 pieces, including

- |                                |                                |
|--------------------------------|--------------------------------|
| Esc'n Plates and Knobs, p. 491 | Flush Sash Lifts, . . . p. 491 |
| Cup Escutcheons, . . . " 906   |                                |

Appropriate Finishes: Copper (CX22) Mult'r 2.3; Bronze (BX67) Mult'r 3.; Silver (SX52) Mult'r 3., (SY55) Mult'r 3.6; Gold (GX10) Mult'r 10.7; Iron (FX80) Mult'r 1.6

STRATFORD—Figs. 3 and 4, above, . . . 30 pieces, including

- |                                 |                              |
|---------------------------------|------------------------------|
| Esc'n Plates and Knobs, p. 491  | Door Pulls, . . . . p. 829   |
| Store Door Handles, . . . " 760 | Push Buttons, . . . . " 897  |
| Cup Escutcheons, . . . " 906    | Push Plates, . . . . " 923*  |
| Flush Sash Lifts, . . . . " 491 | Cabinet Trim, . . . . " 972† |
| Bar Sash Lifts, . . . . " †     |                              |

Appropriate Finishes: Copper (CX22) Mult'r 3.2; Bronze (BX67) Mult'r 3.75; Silver (SX52) Mult'r 3.75, (SY55) Mult'r 4.5; Iron (FX80) Mult'r 2.3

WENTWORTH—Fig. 10, page 756 . . . , 5 pieces, including

- |                                |                              |
|--------------------------------|------------------------------|
| Esc'n Plates and Knobs, p. 491 | Push Buttons, . . . . p. 897 |
| Store Door Handles, . . . 757  |                              |

Appropriate Finishes: Copper (CX22) Mult'r 3.5; Silver (SX52) Mult'r 4.7; Iron (FX80) Mult'r 2.75

\* A few Designs only are shown as examples. † Not illustrated.

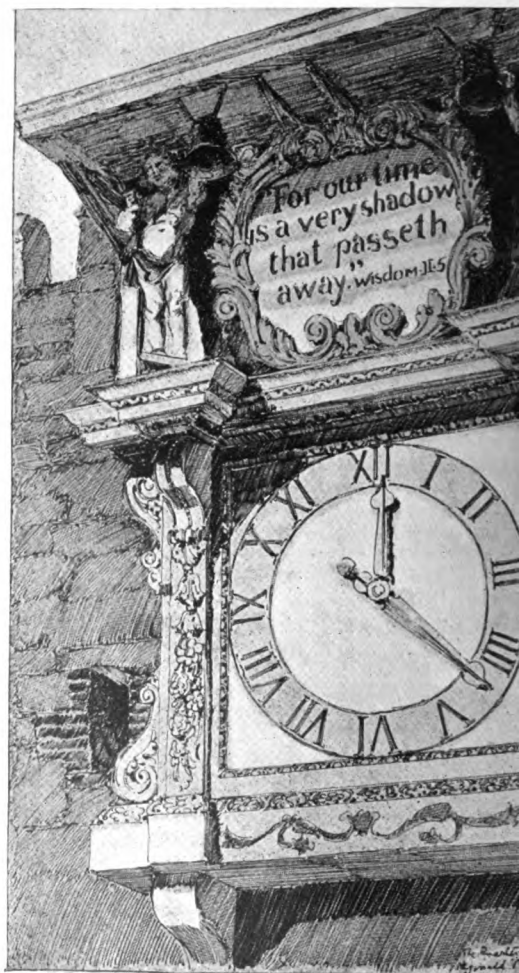

Clock Case and "Quarter-Boys," Rye Church, Sussex

## English Renaissance.

1500 to 1800. Inigo Jones, Gibbs, Wren, Gibbons, Burlington, Chambers, Sheraton, Hepplewhite, Chippendale, Cipriani, Mathias Lock, Copeland, Gillow, Bloomfield, Loftie.



**I**NDIRECTLY quoting Mr. Loftie in "Inigo Jones and Christopher Wren," Jacobean architecture came in gradually toward the end of Elizabeth's reign and through the reign of James I. John of Padua, and other Italian architects and designers, brought about the change, which becoming more pronounced, was helped by the influence of Torregiano, who came to England in 1503, he to whom Michel Angelo owed his broken nose. Torregiano built several mortuary monuments, of which the most noted is the tomb of Henry VII. From this time

on the Italian Renaissance, as interpreted by Palladio, held full sway. Palladio's famous book on architecture was published in Venice in 1570, and was often translated into English, Isaac Ware's four books of Palladio being published through the kindness of Lord Burlington. Largely by these translations and the influence of foreign travel, such men as Inigo Jones, Christopher Wren, James Gibbs, Burlington, Chambers and others, were schooled in the beauties of the Italian master, and were inspired by his spirit.



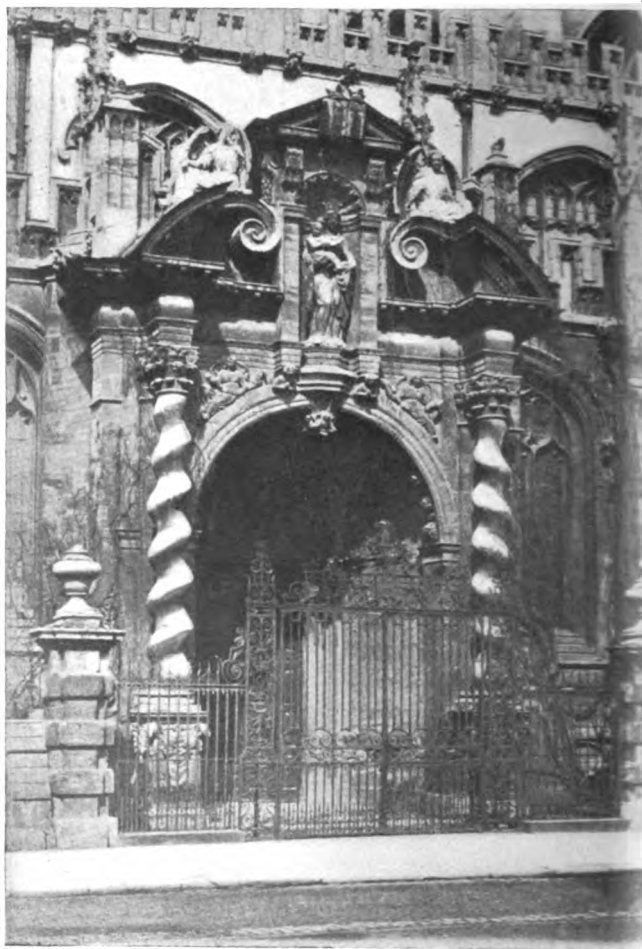

St. Mary's Church Doorway, Oxford.



Casement Fastener, Guilford.

Inigo Jones, born 1573, is the man to whom modern designers of the English-speaking race owe much. He first broke away from the old customs of Elizabeth's time, and instead of leaving details to the master masons and carpenters and carvers, made his own drawings and saw that they were executed. This certainly was a purely professional method, and was followed by Wren also, whose breadth of mind was seen when he allowed Grinling Gibbons full sway, and did not grudge him the fame which this great carver so fairly deserved. Gibbons was born at Rotterdam in 1648, and died in London in 1720. He was a noted sculptor as well as a carver of architectural ornament, in which branch he is the most famous carver of the English Renaissance.

Although Jones gained in precision, rapidity of execution and personality in his buildings, his method, of course, resulted in the loss of the charm which always attracts one to Elizabethan ornament, as executed by master builders and carvers in the mediæval way, which, undoubtedly, in all lands and

Inigo Jones, born 1573, is the man to whom modern designers of the English-speaking race owe much. He first broke away from the old customs of Elizabeth's time, and instead of leaving details to the master masons and carpenters and carvers,



Detail of Gates, All Souls, Oxford.



Gable Ornament, St. Martin's-in-the-Fields.

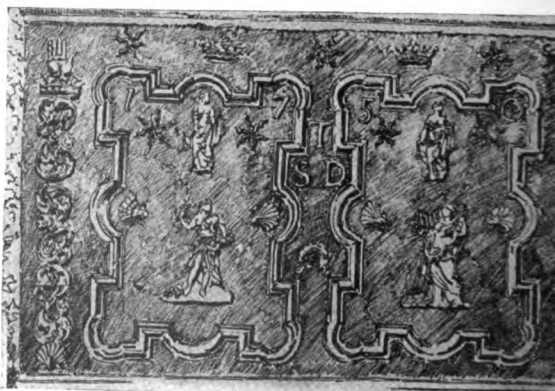

Lead Cistern, East Grinstead.

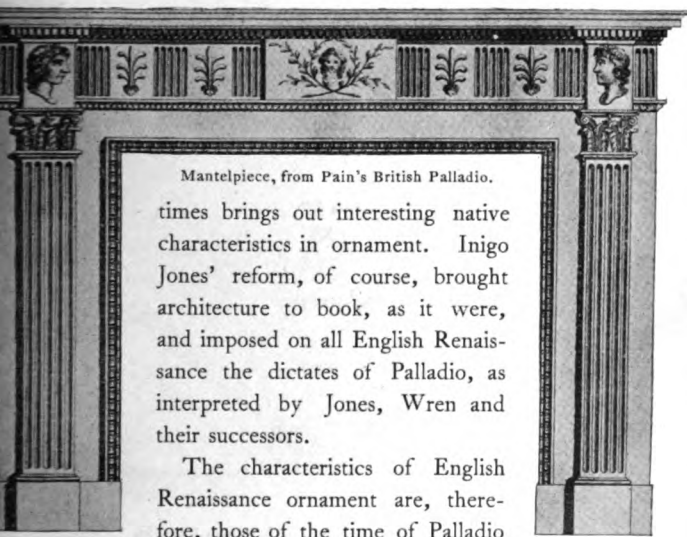

Mantelpiece, from Pain's British Palladio.

times brings out interesting native characteristics in ornament. Inigo Jones' reform, of course, brought architecture to book, as it were, and imposed on all English Renaissance the dictates of Palladio, as interpreted by Jones, Wren and their successors.

The characteristics of English Renaissance ornament are, therefore, those of the time of Palladio

as transformed by English hands, and Gibbons, undoubtedly, was the most potent English interpreter.

Encarpa of flowers and fruit, panels of game and shell and other Italian motifs are found in profusion.

The brothers Adam about 1760 began to exercise a considerable, and sometimes questionable, influence on English architecture and ornament, of which our own Colonial gives evidence at times.

To cite all the names of noted English architects during the Palladian Period, would be beyond the scope of this article, but it is impossible to close without speaking of three great furniture designers of the epoch, namely Sheraton, Hepplewhite and Chippendale. The latter published his *Cabinet Maker's Directory* in 1754, one of the earliest books on furniture in England. Rococo is Chippendale's best vein. Hepplewhite

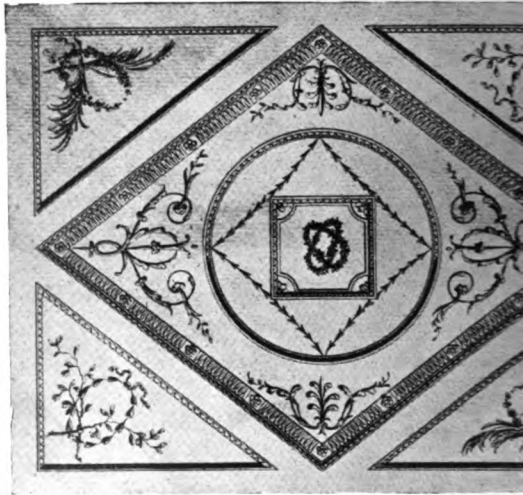

Ceiling in Adam's Style, from Pain's *British Palladio*.

& Co. published a book in 1787-91, and Thomas S in 1791-93. The ornament which all these men influenced our Colonial ornament considerably, and this is in form the best that Anglo-Saxon designers have yet. Among other designers were Cipriani, Mathias Lock and Gillow.

However far the work of the brothers Adam fell from the standard which contemporary critics set up for the true that the style now known as theirs was the most valuable, if not the only work, of this epoch in England showed very strong individuality influenced by precedents much like the ornament of the First Empire in character.

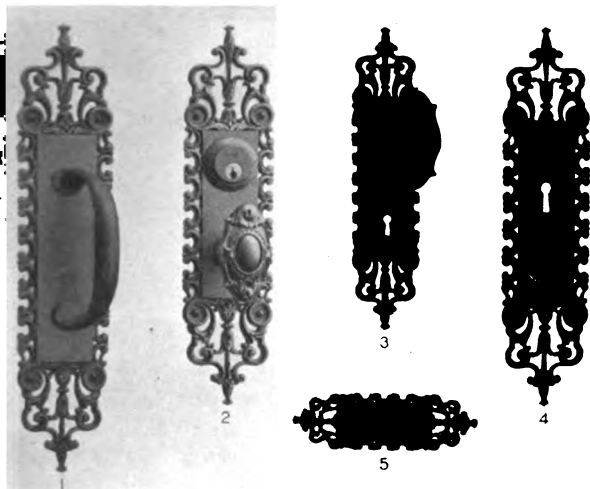

Yale & Towne Designs. English Renaissance.

The Multipliers indicate the relative prices of the various finishes, as compared with prices of corresponding pieces in the Cluny Design, Copper Finish (CX22), pages 734 and 735. For Explanation of Multipliers see page 34. For Explanation of Finish Symbols see page 609.

MANCHESTER—Figs. 1 to 5, above, . . . 34 pieces, including

- |   |                        |
|---|------------------------|
| Esc'n Plates and Knobs, p. 499  | Push Buttons, . p. 896 |
| Cup Escutcheons, . . " 905  | Push Plates, . " 923*  |
| Flush Sash Lifts, Fig.4, " 916  | Hinge Plates, . " 852  |
| Door Pulls, . . . . " 826   | Cabinet Trim, . " 971  |
| Appropriate Finishes: Copper (CY22) Mult'r 2.3; Silver (SY52) Mult'r 3.2; Green Bronze (BX67) Mult'r 3.2; Iron (FX80) 1.6 |                        |

\*A few Designs only are shown as samples.

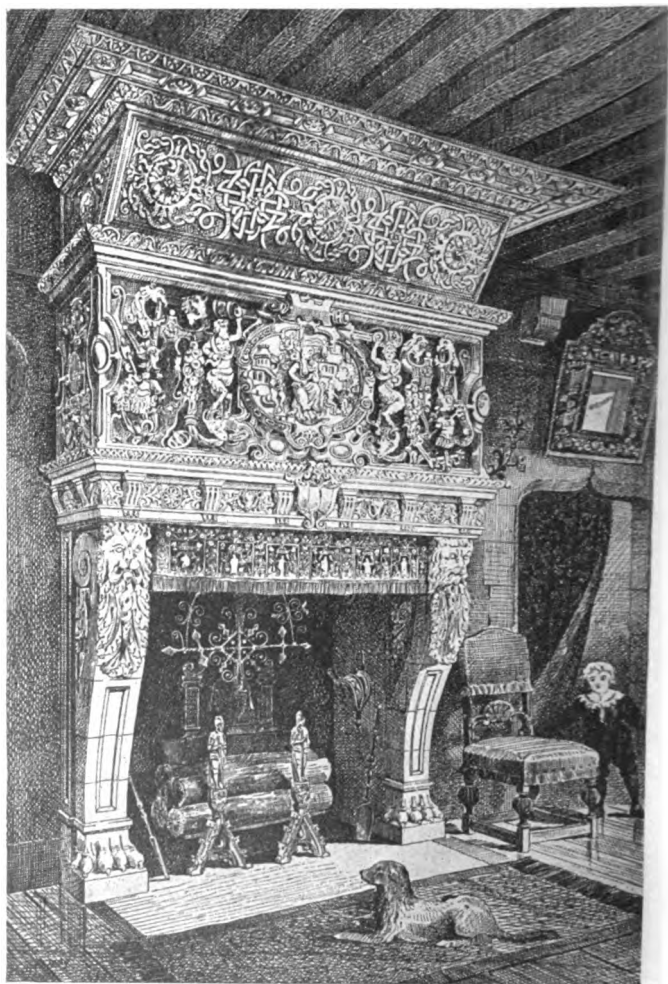

**Chimney Piece in Cluny Museum, Paris. From a house at Troyes.**

## French Renaissance.



HE history of the architecture of any period is to a certain extent the history of its ornament.

As in Italy, the Renaissance in France was a gradual growth fostered by numerous occurrences. The fall of Constantinople in 1453 dispersed thence the most famous Greek scholars who were attracted to those European courts wherein their attainments were most appreciated.

Printing by movable types was discovered by Gutenberg in 1438, and the publication of the recently discovered manuscripts of classic authors disseminated learning and the attendant desire for improvement. Early French painters and sculptors began to draw public attention to the revival of classic art, and the intercourse which Charles VIII, by his wars, opened with Italy, soon bore fruit in the development of the Renaissance spirit in all branches of art. At Orleans we see the Hotel de Ville as finished by Charles Viart in 1498, with Renaissance proportions and much Gothic detail, and a most important and fruitful work was the Chateau de Gaillon, by Senault, Fain and Delome; a transitional building between Gothic and Renaissance. Fragments now in the court of the Ecole des Beaux Arts show how great was the effect which this building had on architecture in the years following.



Detail of Door of Saint Maclou, Normandy.





Cabinet, Avignon, France.

Another cause of the Renaissance in France may have been the fact that Louis XII invited Fra Giocondo to his court, and while the King's personal interest in architecture was, perhaps,



Normandy. Wood Carving from the Atelier of Saint-Andre de l' Eure.

slight, new buildings were gradually erected which carried on the movement of the new art until the time of Francis I.

The characteristics of French Renaissance are not to be fully described in a few words. They vary as the times change and are indicated under the headings of the various reigns separately described, but in spite of change of king and court there were isolated schools, which cannot always be classed with the style in vogue at Paris, and this was particularly true of the ornament and shapes of furniture.

Hence, it will, perhaps, be interesting to give examples of some of the better known work in different parts of France during the Renaissance period, without special reference to the court styles.

The wide range of ornament expressed in these brings clearly to the mind the rich fertility of invention and composition possessed by the cabinet-work designers of the epoch, and illustrates how difficult it is to exactly determine the school or maker without a long and close study of French art.

The vigor and originality displayed in design through the dif-



Normandy. Wood Carving from the Atelier of Saint-Andre de l' Eure,



Panel.

ferent reigns shows that the influence of Romanesque and Gothic work was powerful, and that the beautiful early peasant carvings were especially noted and appreciated by the best craftsmen, even as they are to-day. As, in the same epoch, in Germany, so in France, Switzerland, and even England, we find in these early peasant carvings much that must have inspired the designers of the Renaissance, and but for the Italian Renaissance there might have grown from this work a school in each country much closer to national ideals in art. But the French Renaissance was un-



Arabesques from Chateau Gaillon



Carvings from Chateau Gaillon.

doubtedly the best school which sprang from the Italian, and yet it is from some of the smaller towns that some of the most beautiful examples came, and where the most original and exquisite work was constantly done. Single workshops set the pace for certain districts and masters arose whose fame to-day is cherished by the French, as was that of the little masters of German engraving.

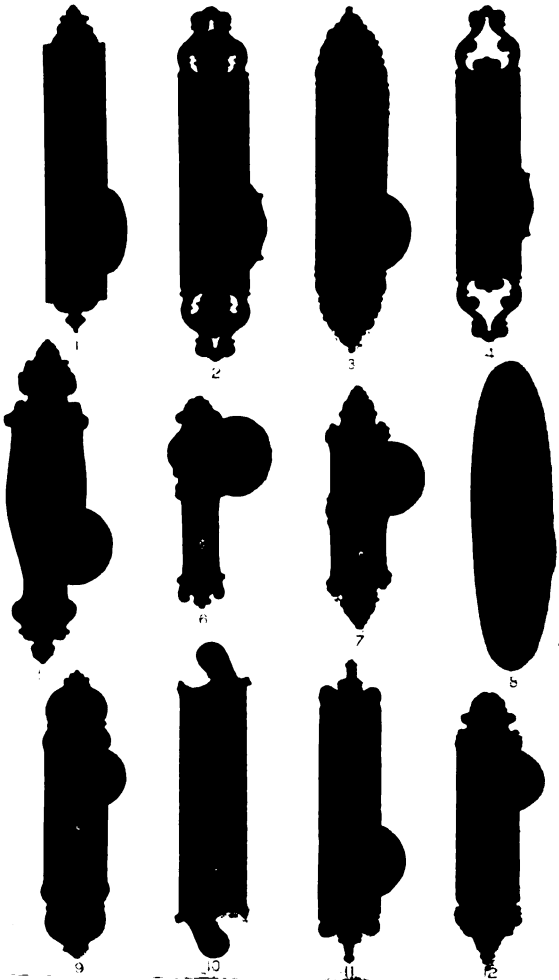

## Yale &amp; Towne Designs. French Renaissance.

The Multipliers indicate the relative prices of the various Designs and Finishes as compared with prices of corresponding pieces in the Cluny Design, Upper Finish (CX22), pages 734 and 735. For Explanation of Multipliers see page 54.

For Explanation of Finish Symbols see page 100.

AMBOISE—Fig. 11, page 506, . . . . 46 pieces, including

Esc'n Plates and Knobs, p. 506	Drawer Pulls, . . p. 925
Store Door Handles, . . " 745	Door Pulls, . . " 823
Cup Escutcheons, . . " 904	Push Buttons, . . " 895
Flush Sash Lifts, . . " 916*	Push Plates, . . " 923*
Letter Drop Plates, . . " 917*	

Appropriate Finishes: Copper (CX22) Mult'r 1.4; Silver (SX52) Mult'r 2.2; Gold (GY10) Mult'r 8.25; Iron (FX80) Mult'r 1.

ANET—Fig. 12, page 506 . . . . 10 pieces, including

Esc'n Plates and Knobs, p. 506	Drawer Pulls, . . p. 925
Cup Escutcheons, . . " 904	Shutter Knobs, . . " 940
Flush Sash Lifts, Fig. 2, " 916	

Appropriate Finishes: Copper (CY22) Mult'r 3.; Silver (SY52) Mult'r 3.7, (SY55) Mult'r 4.5; Gold (GY10) Mult'r 11.8; Iron (FX80) Mult'r 2.2; Hand Chasing, Mult'r 1.8 additional.

ANGOULEME—Figs. 1 to 4, page 976, . . Cabinet Trim only.

ARGONNE—Fig. 9, page 830, . . . . Door Pull only.

BIARRITZ—Fig. 2, page 506, . . . . 41 pieces, including

Esc'n Plates and Knobs, p. 506	Lever Handles, . . p. 879
Cup Escutcheons, . . " 904	Door Pulls, . . " 824
Flush Sash Lifts, Fig. 8, " 916	Push Buttons, . . " 895
Letter Drop Plates, . . " 917*	Push Plates, . . " 923*

Appropriate Finishes: Copper (CX22) Mult'r 2.2; Silver (SX52) Mult'r 3.; Gold (GX12) Mult'r 11.7; Iron (FX80) Mult'r 1.5

CHANTILLY—Fig. 4, page 506, . . . . 40 pieces, including

Esc'n Plates and Knobs, p. 506	Door Pulls, . . p. 804
Cup Escutcheons, . . " 904	Push Buttons, . . " 895
Flush Sash Lifts, . . " 916*	Push Plates, . . " 823*

Appropriate Finishes: Copper (CX22) Mult'r 2.2; Silver (SX52) Mult'r 3.; Gold (GX12) Mult'r 11.7

\* A few Designs only are shown as examples.

- COMO**—Fig. 5, page 506, . . . . . 46 pieces, including
- |                                |                         |
|--------------------------------|-------------------------|
| Esc'n Plates and Knobs, p. 506 | Push Plates, . . p. 923 |
| Cup Escutcheons, . . " 904     | Shutter Knobs, . " 940  |
| Flush Sash Lifts, . . " 916*   | Cabinet Trim, . " 966   |
| Push Buttons, . . . " 895      |                         |
- Appropriate Finish: Copper (CX22) Mult'r .85
- CONDE**—Fig. 64, page 936, . . . . . Drawer Pull only.
- DORMANS**—Fig. 8, page 506, . . . . . 41 pieces, including
- |                                |                          |
|--------------------------------|--------------------------|
| Esc'n Plates and Knobs, p. 506 | Push Buttons, . . p. 896 |
| Cup Escutcheons, . . " 905     | Push Plates, . . " 923*  |
| Flush Sash Lifts, . . " 916*   | Shutter Knobs, . " 940   |
| Drawer Pulls, . . . " 926      | Key Plates, . . . " 953  |
| Door Pulls, . . . . " 825      |                          |
- Appropriate Finishes: Brass (AY10) Mult'r 1.4, (AY22) Mult'r 1.4, (AZ15) Mult'r 1.4; Copper (CY22) Mult'r 1.4; Silver (SY52) Mult'r 2.; Gold (GY10) Mult'r 7.4
- DREUX**—Fig. 1, page 506, . . . . . 42 pieces, including
- |                                |                           |
|--------------------------------|---------------------------|
| Esc'n Plates and Knobs, p. 506 | Door Pulls, . . . p. 825  |
| Cup Escutcheons, . . " 905     | Push Buttons, . . " 896   |
| Flush Sash Lifts, . . " 916*   | Push Plates, . . . " 923* |
| Cremorne Bolts, . . . " 887    | Shutter Knobs, " 940†     |
- Appropriate Finishes: Copper (CY22) Mult'r 1.6; Silver (SY52) Mult'r 2.25; Gold (GZ10) Mult'r 9.5; Iron (FX80) Mult'r 1.
- DUNKIRK**—Fig. 1 page 874, . . . . . Door Knocker only.
- DURO**—Fig. 7, page 506, . . . . . 17 pieces, including
- |                                |                           |
|--------------------------------|---------------------------|
| Esc'n Plates and Knobs, p. 506 | Hook Sash Lifts, p. †     |
| Store Door Handle, . . " 749   | Push Buttons, . . " 896   |
| Cup Escutcheons, . . " 905     | Push Plates, . . . " 923* |
| Flush Sash Lifts, . . . " 916* | Key Plates, . . . " 953   |
- Appropriate Finishes: Iron, Copper Plated (FCX22) Mult'r .25; Iron (FX80) Mult'r .5
- EPINAL**—Fig 63, page 936, . . . . . Drawer Pull only.
- FERMO**—Fig. 6, page 506, . . . . . 22 pieces, including
- |                                |                          |
|--------------------------------|--------------------------|
| Esc'n Plates and Knobs, p. 505 | Push Buttons, . . p. 896 |
| Cup Escutcheons, . . " 905     | Key Plates, . . . " 953  |
| Flush Sash Lifts, . . . " 916* |                          |
- Appropriate Finish: Copper (CX22) Mult'r .85
- GORDIAN**—Fig. 9, page 506, . . . . . 34 pieces, including
- |                                |                           |
|--------------------------------|---------------------------|
| Esc'n Plates and Knobs, p. 505 | Door Pulls, . . . p. 825  |
| Cup Escutcheons, . . . " 905   | Push Buttons, . . " 896   |
| Flush Sash Lifts, . . . " 916* | Push Plates, . . . " 923* |
| Hook Sash Lifts, . . . " †     | Key Plates, . . . " 954   |

\* A few Designs are shown as examples. † Not illustrated.

- GRENOBLE**—Fig. 3, page 506, . . . 44 pieces, including  
 Esc'n Plates and Knobs, p. 506                      Push Buttons, . p. 896  
 Cup Escutcheons, . . . " 905                      Push Plates, . . " 923\*  
 Flush Sash Lifts, . . . " 916\*                      Cabinet Trim, . . " 969  
 Door Pulls, . . . . . " 825  
 Appropriate Finishes: Copper (CX22) Mult'r .95; Silver (SY52)  
 Mult'r 1.6; Iron (FX80) Mult'r .7
- MARLAI**X—Fig. 12, page 874, . . . Door Knocker only.
- MENTZ**—Figs. 8 and 9, page 838, . . . Door Pulls only.
- OPORTO**—Fig. 9, page 594A, . . . 54 pieces, including  
 Esc'n Plates and Knobs, p. 594A                      Door Pulls, . . p. 827  
 Store Door Handles, . . . †                      Push Buttons, . . " 897  
 Cup Escutcheons, . . . " 906                      Push Plates, . . " 923\*  
 Flush Sash Lifts, . . . " 916\*                      Shutter Knobs, . . " 940†  
 Letter Drop Plates, . . . " 917\*                      Cabinet Trim, . . " 972A  
 Extension Bolts, . . . . . " 894\*  
 Appropriate Finishes: Brass (AZ17) Mult'r .9; Copper (CX17)  
 Mult'r .9; Nickel (NZ17) Mult'r .9
- ORLEANS**—Fig. 20, page 875, . . . Door Knocker only.
- PARIS**—Fig. 19, page 875, . . . Door Knocker only.
- RENNES**—Fig. 87, page 959, . . . Key Plate only.
- SEVRES**—Fig. 10, page 506, . . . 18 pieces, including  
 Esc'n Plates and Knobs, p. 506                      Hinge Plates, . p. 854  
 Store Door Handle, . . . " 755                      Push Buttons, . . " 897  
 Extension Bolts, . . . . . " 894\*                      Push Plates, . . " 923\*  
 Door Pulls, . . . . . " 828  
 Appropriate Finishes: Copper (CX22) Mult'r 2.5; Green Bronze  
 (BX67) Mult'r 3.3; Silver (SX52) Mult'r 3.3; Iron (FX80) Mult'r 2.
- St. Denis**—Fig. 13, page 875, . . . Door Knocker only.
- TOULOUSE**—Fig. 62, page 936, . . . Drawer Pulls only.
- TROUVILLE**—Fig. 2, page 874, . . . Door Knocker only.
- VERCELLI**—Fig. 4, page 842, . . . Door Pull only.
- VERZI**—Fig. 7, page 874, . . . Door Knocker only.

\*A few Designs only are shown as examples. † Not illustrated.



**Doors, by Pierre Collot.**

## Louis XIII.

Born at Fontainebleau 1601. Died at St. Germain-on-Laye 1643. François Blondel, François Mansard, Jacques Lemercier, de Brosse, Pierre Collot.



LOUIS XIII, son of Henry IV, reigned from 1610-1643. During this period the Italian influence still shows clearly. The cartouche, encarpus, wreath, ribbons, cherub and masque are quite freely used, and the disposition of emphatic portions of the design carefully studied or done with the instinct of hereditary talent.

We see a roundness in the stems of the arabesques in some designs, a flatness in others almost of a paper-like thinness, shaded to distinguish them still further, and panels of attributes, such as arms or trophies.

The cartouche, generous in scale, often grotesque and with heavy fruit pendants, is in vogue, and its edges cut into curling tendrils of a somewhat bulky character, which, together with slightly indicated eyes or noses, produce grotesques of varying expression.

This might be said to be one of the pronounced characteristics of the school. Pierre Collot, an architect of the day, made himself known



Panel of Chest.





Panel.

outside of his constructions by a collection of designs, published in 1633 by Van Lochom, a Flemish engraver.

The sculpture in stone and wood of this period is of excellent scale, and carries well. The eye is struck by a certain generosity of relief and breadth of surface on all the modeled surfaces. Pediments were broken by cartouches, and sometimes, it would almost seem, broken beyond repair, but were not

so frequent as in later schools. Battle scenes are carved in panels and the horses have Percheron or Flemish legs and hoofs, it is hard to say which. The broken curve is used in consoles with the acanthus on the face.

Richelieu was prime minister (1624-42) to Louis XIII and the patron of the famous architect, Jacques Lemercier, who built for him the Chateau Richelieu, at Richelieu, and the Palais Richelieu at Paris, later called the Palais Royal, also the Sorbonne, also carried on the work of Lescat at the Louvre and built the Pavilion d'Orloge on the western side, and other monumental structures. He was also architect to the King.



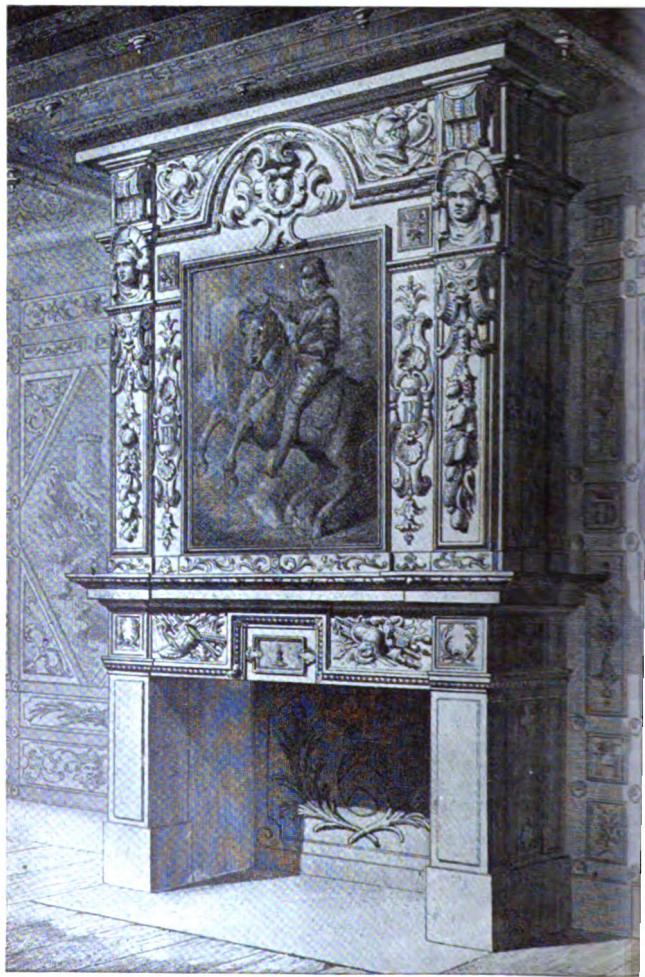

Mantelpiece in Hall, Chateau Cormatin, France.

## Yale & Towne Designs.

### Louis XIII.

*The Multipliers indicate the relative prices of the various Designs and finishes as compared with prices of corresponding pieces in the Cluny Design, Copper Finish (CX22), pages 734 and 735. For Explanation of Multipliers see page 34.*

*For Explanation of Finish Symbols see page 609.*

ANTWERP—Fig. 1, 4 pieces, including

Store Door Handles, . . . .	p. 745
Cylinder Faces, . . . .	“ 924
Push Buttons, . . . .	“ 895

Appropriate Finishes: Copper (CX22) Mult'r 2.3; Silver (SX52) Mult'r 3.75, (SY55) Mult'r 5.1; Gold (GX10) Mult'r 16.3; Iron (FX80) Mult'r 1.7

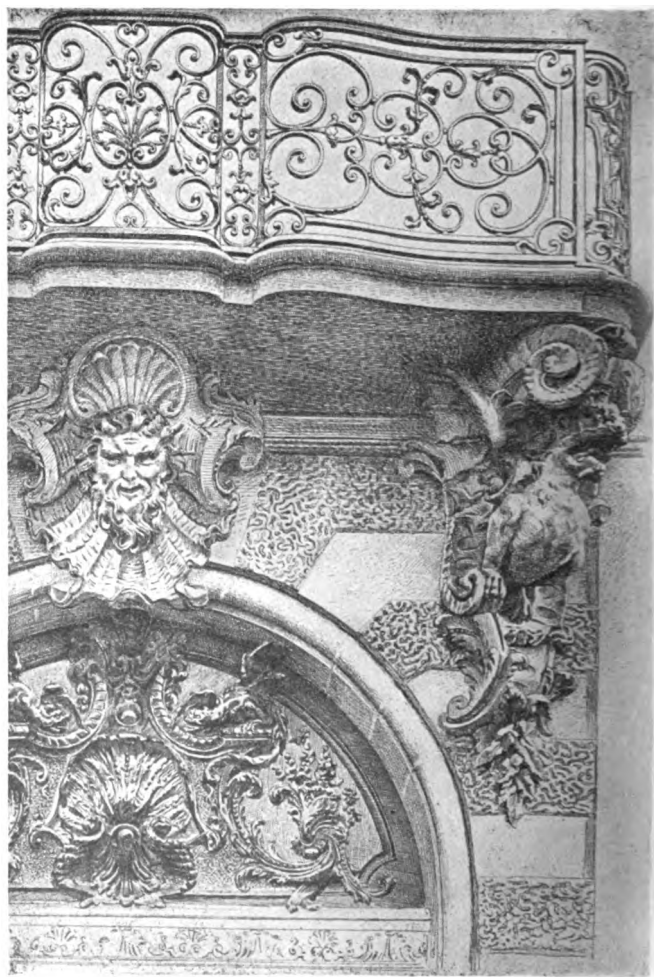

**Balcony and Doorway, Rue St. Louis-en-l'Île, Paris.**

## Louis XIV.

born at St. Germain-en-Laye 1638. Died at Versailles 1715. Colbert, Louis' minister of finance, founded the "Academie Royale" of architecture, sculpture and painting, and established the famous factory of the Gobelins tapestries, named from the brothers Gobelins, dyers. Le Pautre, Watteau, Boule, Caffieri, du Goulon, Pineau, Romie, Toro, Julience, Charmeton, Jean Berain, J. H. Mansard, J. B. A. le Blond, Claude Perrault, Aviler, de Cotte, Puget, Le Brun, Soufflot, Bullet, J. B. Toro.



THE reign of Louis Le Grand extended from 1643 to 1715. Great he was. Great were his armies, his wars and his victories. Great was his architecture and its ornament, and great were his Mistress de Maintenon, his bigotry, his cruelty to the Hugue-

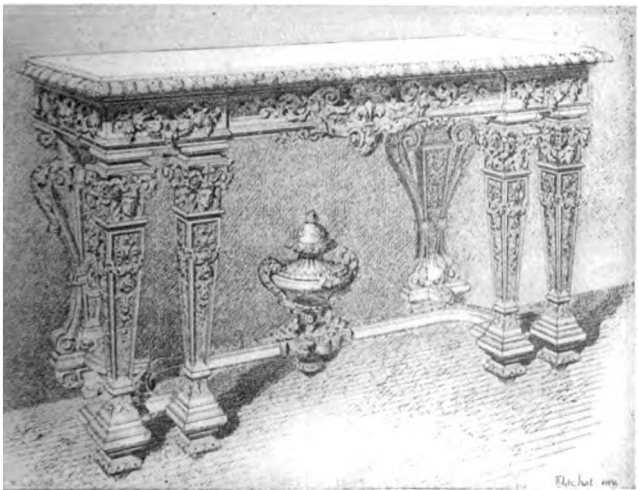





Designs by J. B. Toro.

nots and his sowing of taxes and oppressions, bearing fruit finally in the greatest social uprising of man against man which the world has ever known, the Revolution. Here then was a period in which we might expect to see fine wares brought to market when such a lively King and court were purchasers, and fine indeed are the designs of the time. A studied elegance and



Design by J. B. Toro.



Panel by Simon Vouet.

restraint such as would please one of the most cultivated and luxurious courts of Europe is indicated in all designs.

Among the repetitions of ornament observable are the acanthus or other foliage, often with sharply serrated edges when used in flat decorations and shells. Latticed backgrounds on panels appear, and the massive work of Le Pautre in tiresome heaviness and richness sug-

gests the era of discomforts and ponderous powdered wigs and of other court paraphernalia which must have burdened eye and body. But Le Pautre was not in an architectural sense "l'etat." There is, besides his, a considerable variety in the work of other designers of the period, such as Boulle, Caffieri, du Goulon, Pineau, Charmeton, etc., and a great delicacy is observable in flat mural decoration, book covers, etc. Jean Berain, designer and draughtsman, produced prolifically sketches of all kinds, from tableware and plate up to more important works.

At Versailles the tendency to greater freedom appears, and the cartouche develops a pronounced smooth boss with more curl to the enveloping foliage, while the consoles become more refined, the borders more perfect, with their straight reeds intersected frequently by curved leaves or other ornamental



Bottom of Panel.



Capitals by J. Berain.

interruptions. The Roman still crops out in heavy mouldings in bigness of motif, here and there, but the tendency is finally toward the coming carnival of Rococo.

This was the Augustan age of arts and letters for France, and Corneille, Racine and Moliere are names whose works offset much of the disaster soon to follow.

Among the architects Jules Hardouin Mansard was a favorite of Louis XIV, and built the Palace of Versailles and the Invalides.

This was not the one who invented the Mansard roof, that being a production of his uncle, François Mansard.



Capitals by J. Berain.



Panel by Le Pautre.

Le Brun and Pierre Bullet also flourished at this period, and Soufflot did many important works, among them the Pantheon at Paris.

Claude Perrault built the east façade and colonnades of the Louvre, ranking as one of the great architectural designs of Europe.

The designs of Le Pautre are distinguished by their great richness and solidity, such as marked certain periods of the Italian Renaissance, and they were and still are widely published and

studied. Berain's designs show a deep knowledge of the effectiveness of contrasting scale in ornament, and of the value of the interlace, when used with radically different forms such as foliage, fruit, etc. The lack of just such knowledge accounts for much of the uninteresting modern work.

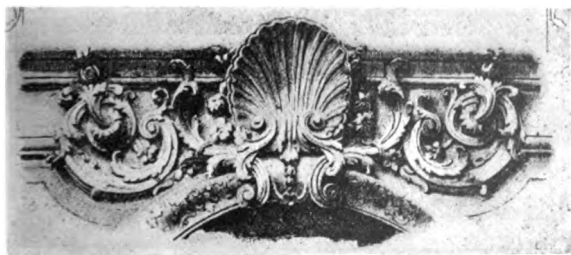

Woodwork, Chateau de Bercy.



2



3



4



5



## Yale &amp; Towne Designs.

## Louis XIV.

The Multipliers indicate the relative prices of the various Designs and finishes, as compared with prices of corresponding pieces in the Cluny Design, Copper Finish (CX22), pages 734 and 735. For Explanation of Multipliers see page 34. For Explanation of Finish Symbols see page 109.

## CHARLEMONT—Fig. 1, page 522, . . . 9 pieces, including

Esc'n Plates and Knobs, p. 522	Lever Handles, p. 878*
Cremorne Bolts, . . . " 890*	Screw Rosettes, " †
Extension Bolts, . . . " 894*	

Appropriate Finishes: Brass (AZ15) Mult'r 1.3, (AZ19) Mult'r 1.3; Silver (SY55) Mult'r 2.75; Gold (GZ10) Mult'r 6.3

## MAILLY—Fig. 70, page 959, . . . Key Plate only.

## MARIVAUX—Fig. 11, page 594A, . . . 5 pieces, including

Esc'n Plates and Knobs, p. 594A	Flush Sash Lifts, p. 916*
Cup Escutcheons, . . . " 905	

Appropriate Finishes: Brass (AZ15) Mult'r 3.25; Copper (CY22) Mult'r 3.25; Silver (SX52) Mult'r 3.9, (SY55) Mult'r 4.75; Gold (GZ10) Mult'r 11.7

## MENIN—Figs. 2, 5 and 6, page 522, . . . 9 pieces, including

Esc'n Plates and Knobs, p. 522	Door Pulls, . . p. 827
Cup Escutcheons, . . . " 905	Push Buttons, . . " 896
Flush Sash Lifts, . . . " 916*	Push Plates, . . " 923*

Appropriate Finishes: Copper (CY22) Mult'r 3.; Brass (AZ15) Mult'r 3.; Silver (SX52) Mult'r 3.7, (SY55) Mult'r 4.4; Gold (GY10) Mult'r 12.; Iron (FX80) Mult'r 2.

## VERSAILLES—Figs. 3, 4, 7 and 8, page 522, 26 pieces, including

Esc'n Plates and Knobs, p. 522	Door Pulls, . . p. 829
Store Door Handles, . . " 757	Push Buttons, . . " 897
Cup Escutcheons, . . . " 906	Push Plates, . . " 923*
Flush Sash Lifts, . . . " 916*	

Appropriate Finishes: Brass (AY22) Mult'r 3.4; Copper (CY22) Mult'r 3.4; Silver (SY52) Mult'r 4.3, (SY55) Mult'r 5.2; Gold (GY10) Mult'r 13.75; Hand Chasing, Mult'r 1.6 additional.

\*A few Designs only are shown as examples. † Not illustrated.



Hotel, Rue du Cherche Midi, Paris.

## Louis XV.

Born at Versailles 1710, died at Versailles 1774. J. Le Pautre, Boffrand, Pigotte, Blondel, Babel, Jacques and Phillippe Cafferi, Charles Cressent, Oeben, Verberckt and Maurisan-Boucher, Cuvillies, Martin, Nicole.



○ age has more clearly told its story through the medium of ornament than those years during which France bore on her back this "old man of the sea," whose reign began in 1715 and ended in 1774. The manners and morals of the court are reflected in the art of the day. The rouge and patch are almost recognizable, and lace petti-

coats are flaunted in the face of the world.

The freedom of this Rococo art is but the result of the spirit of the times. Are not gaiety, variety, abandon, fickleness, millinery, jewelry and good wines and frailty its attributes? Any student of history could write the story from its art if he had never heard of France.

Perhaps of all the earmarks of the style, the eye lights first on the uses of the reversed curves and the cartouche. The beauty of the ornament is certainly great in its imaginative and airy quality. It may not be appropriate to call Louis XV an "old man of the sea," but the ornament of the day, Rococo, is derived from "rocaille" the rocks, seaweed, shells, and what not of the beach.

Almost like the foam of the sea are swift turns



Silverware.  
P. Germain.





Carriage Entrance, 56 Rue de Varrenes, Paris.



Carvings from Parisian Facades.

and curves of its lines, and on its crests, as of old, Venus (in the form of the Pompadour,) later metamorphosed into Du Barry,

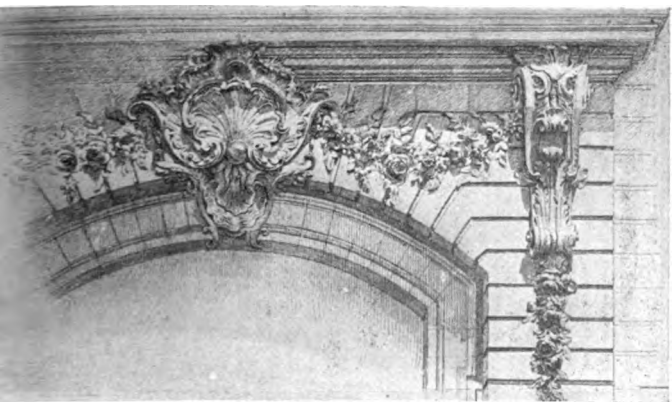

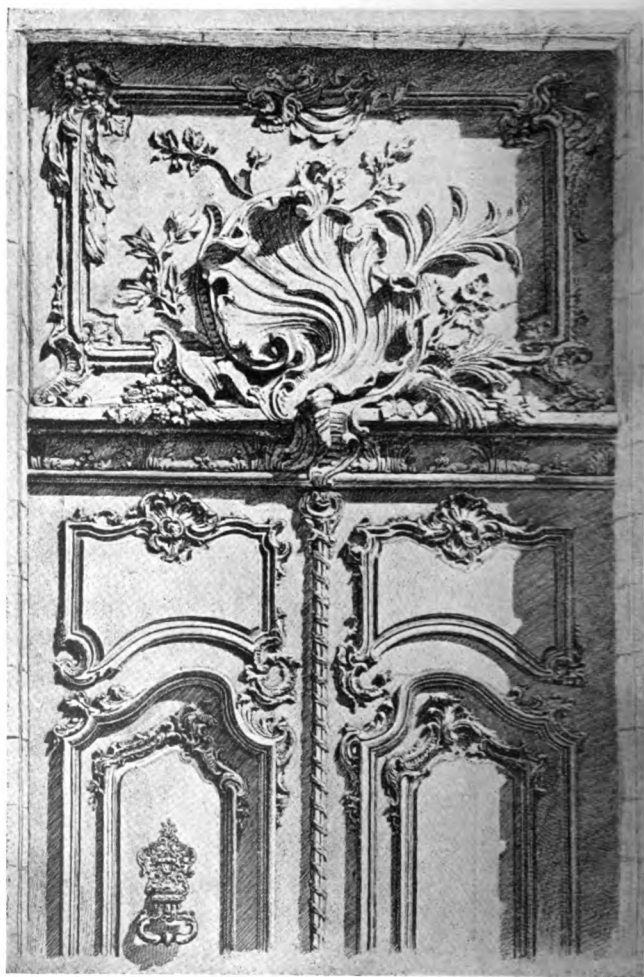

Doorway at Dijon.  
Digitized by Google



Silverware.  
P. Germain.

is wafted into power, with a vicious king, over restless France. The restraint of the court of Louis Le Grand is thrown aside, and with it the art of the day, and we see the fickle character of one in the other. Until within a few years it has been the vogue to decry Rococo. This was a natural feeling in the minds of those on whom the horrors of later imitations of this



Vase at  
Vic-s-Seille.

school had made a greater impression than the beauties which are so manifest in the best French examples. It is doubtful whether the world will ever see a successful revival of the Rococo. It was the volatile, versatile, imaginative Frenchman who produced it in a devil-may-care time and under the intoxicating inspiration of a rule which France will probably—and happily if so—never see again.

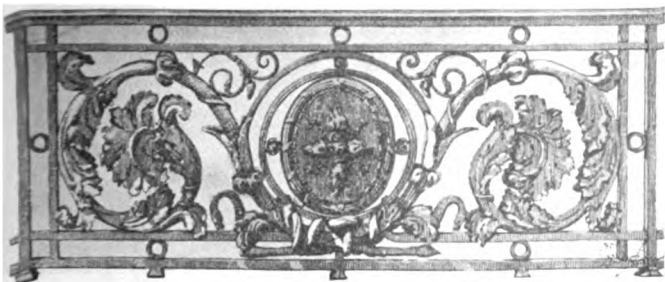

Balustrade, Late Louis XV.

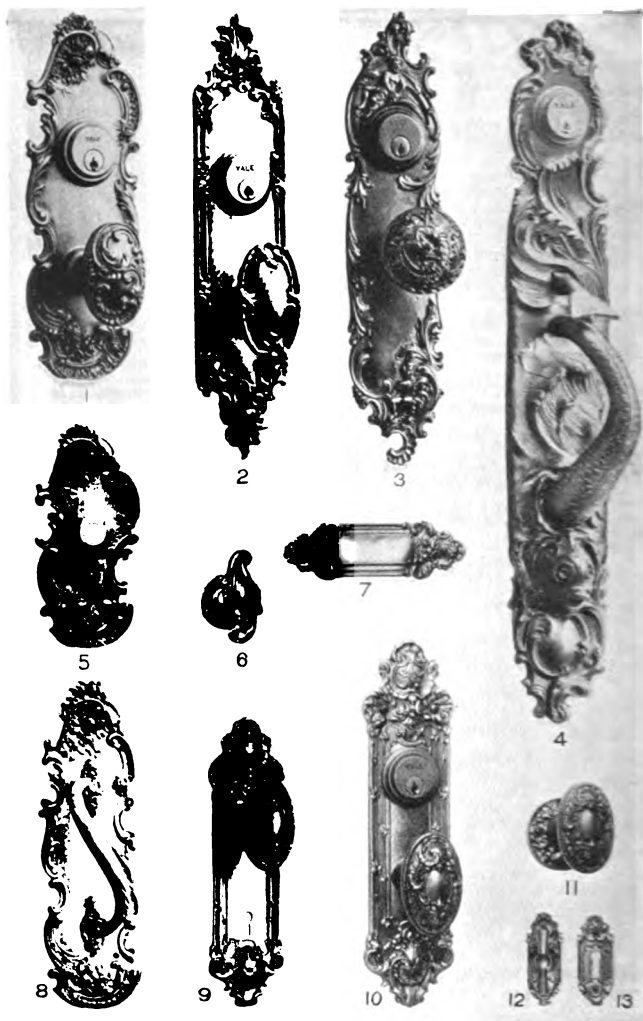

## Yale &amp; Towne Designs.

## Louis XV.

The Multipliers indicate the relative prices of the various Designs and finishes as compared with prices of corresponding pieces in the Cluny Design, Copper Finish, (CX22), pages 734 and 735. For Explanation of Multipliers see page 54. For Explanation of Finish Symbols see page 609.

ALX—Figs. 3 and 4, page 830, . . . Doors Pulls only.

BRETON—Fig. 1, page 594A, . . . 17 pieces, including

Esc'n Plates and Knobs, p. 594A	Flush Sash Lifts, . . . p. 916*
Cup Escutcheons, . . . " 904	Push Plates, . . . " 923*
Appropriate Finishes: Brass (AZ15) Mult'r 1.9; Silver (SX52) Mult'r 2.4, (SY55) Mult'r 3.; Gold (GZ10) Mult'r 10.	

FLEURY—Fig. 2, page 530, . . . 49 pieces, including

Esc'n Plates and Knobs, p. 530	Lever Handles, . . . p. 879
Store Door Handles, . . . " 751	Door Pulls, . . . " 825
Cup Escutcheons, . . . " 905	Push Buttons, . . . " 896
Flush Sash Lifts, Fig. 10 " 916	Push Plates, . . . " 923*
Cremorne Bolts, . . . " 887	Cabinet Trim, . . . " 968
Appropriate Finishes: Copper (CX22) Mult'r 1.2; Silver (SX52) Mult'r 2., (SY55) Mult'r 2.5; Gold (GX10) Mult'r 8.; Iron (FX80) Mult'r .85	

FONTENOY—Figs. 1, 5 and 8, page 530, 40 pieces, including

Esc'n Plates and Knobs, p. 530	Door Pulls, . . . p. 825
Cup Escutcheons, . . . " 905	Push Buttons, . . . " 896
Flush Sash Lifts, . . . " 916*	Push Plates, . . . " 923*
Hook Sash Lifts, . . . " †	Shutter Trim, Figs. 2
Bar Sash Lifts, . . . " †	and 5. . . . . " 922
Extension Bolts, . . . " 894*	Cabinet Trim, . . . " 968
Lever Handles, . . . " 879	
Appropriate Finishes: Brass (AZ15) Mult'r 2.7; Copper (CY22) Mult'r 2.7; Silver (SY52) Mult'r 3.25; Gold (GY10) Mult'r 10.; Hand Chasing, Mult'r 1.5 additional.	

MARLY—Fig. 4, page 530, . . . 12 pieces, including

Esc'n Plates and Knobs, p. 530	Hinge Straps, . . . p. 852
Store Door Handles, . . . " 751	Push Buttons, . . . " 896
Door Pulls, . . . " 826	Push Plates, . . . " 923*
Appropriate Finishes: Brass (AZ15) Mult'r 2.6; Copper (CX22) Mult'r 2.6; Silver (SX52) Mult'r 3.4; Iron (FX80) Mult'r 2.	

NAVARRO—Figs. 7, and 9 to 13, page 530, 56 pieces, including

Esc'n Plates and Knobs, p. 530	Door Pulls, . . . p. 827
Store Door Handles, . . . " 760	Push Buttons, . . . " 896
Cup Escutcheons, . . . " 906	Push Plates, Fig. 1, . . . " 923
Flush Sash Lifts, . . . " 916*	Shutter Knobs, . . . " 941
Letter Drop Plates, . . . " 917*	Cabinet Trim, . . . " 972
Extension Bolts, . . . " 894*	
Appropriate Finishes: Brass (AX17) Mult'r .65; Bronze (BX12) Mult'r .65; Copper (CX17) Mult'r .65	

VILLEROI—Fig. 3, page 530, . . . 14 pieces, including

Esc'n Plates and Knobs, p. 530	Push Plates, . . . p. 923*
Appropriate Finishes: Copper (CY22) Mult'r 3.5; Silver (SX52) Mult'r 4.4, (SY55) Mult'r 5.3; Gold (GZ10) Mult'r 14.; Hand Chasing, Mult'r 1.4 additional.	

\*A few Designs only are shown as examples. †Not illustrated.



Versailles, Staircase Hall, at the Little Trianon.

## Louis XVI.

n at Versailles 1754. Died at Paris 1793. L. F. Casas, Boucher, De la Fosse, Martin Carlin, Ranson, Gabriel, Mique, Patte, Levasseur, Riesener, Roentgen, Cauvet, Selen, Beneman, Gouthiere, De Chammont, Roubo, d'Inard, De la Londe, J. A. Renard, Hugard.



Bronze Frame by I. Berthen.

INCREASING reaction from the excesses of the previous court marked the manners and arts of that of Louis XVI who reigned from 1774 to 1792.

We Americans owe him a debt for recognition of our independence in 1788, and the assistance he then sent us.

The flourish of the Rococo is gone and in the best examples only an echo of



Copper Medallions, Louis XVI, and Marie Antoinette.





Frieze.

it is noted in the subdued lines, curves and contours of a more sedate and classical character. Garlands of fruit and flowers, with pine cones for finials, are used with many another classic fragment, and the effect is one of stateliness, the finish generally being excellent. Vases, griffins, cherubs, palms, etc., old Roman friends, are introduced again, with often but little difference in handling, and the ornamental effect, though rich, is not overdone. Where curved borders are used the curves are not violent, but merely reminiscent, at times, of Louis XV. Borders are generally in straight lines with rectangular



Vase by T. Hugard.

breaks and the pearl, guilloche and ribbon resorted to. In fact the ribbon is most ingeniously designed in borders and frames.

Le Petit Trianon at Versailles, was built by Louis XV in



Panel.



Key Bow.

1766, and given by Louis XVI to Marie Antoinette. Aside from its associations this is a most interesting example of architecture of the period, and its details and composition, and even the building itself, have been studied and copied by later architects and designers in many lands.

It is not a pleasant thought that so much beautiful architecture and ornament was produced at the expense of the tax-ridden peas-

ant, but the only bright side of the fact is that the taxes were not all spent for worse things. This thought is one which comes frequently in the study of all forms of art. It seems as if the oppression of rulers was often the immediate cause of great advances in design. Behind the dazzling light of the Italian Renaissance is the steady sombre background of the cruelty and rapaciousness of the petty tyrants of the Italian cities, and so in France, and Russia, and Spain, the iron hand of despotism often seemed to the great artist to be only waving a



Vase at Versailles.

welcome invitation to the arts to enter and live joyously in the respective courts. Out of the swamps of political corruption strangely enough this flower of good architecture sometimes springs, but it is most frequently the production of despotic rule and not a growth from a corrupted republic.



Key Bow.

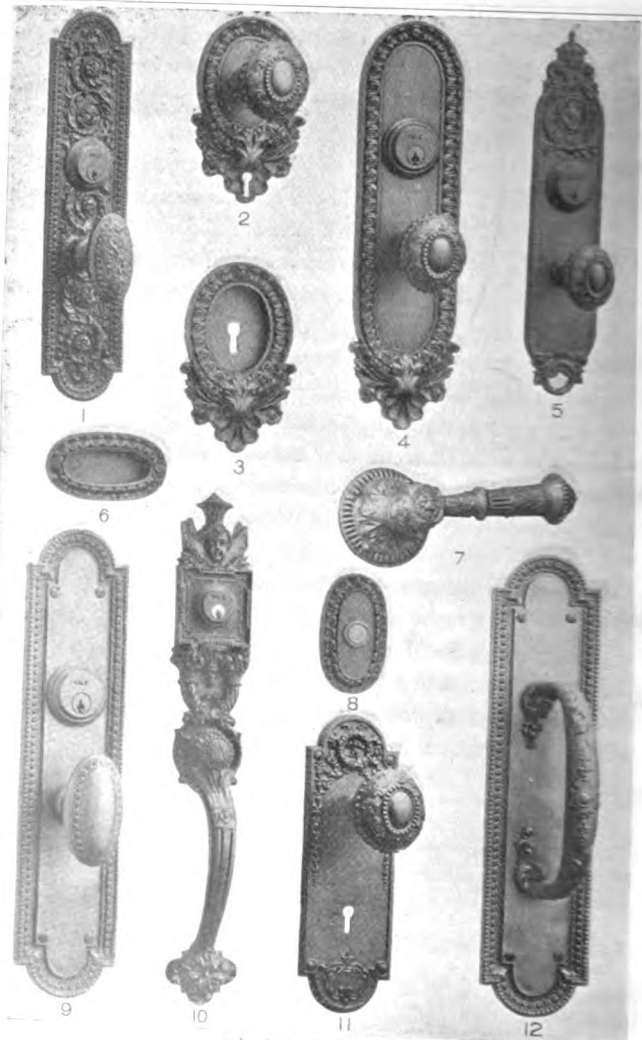

## Yale &amp; Towne Designs.

## Louis XVI.

The Multipliers indicate the relative prices of the various Designs and finishes, as compared with prices of corresponding pieces in the *Cuny Design, Copper Finish (CX22)*, pages 734 and 735. For Explanation of Multipliers see page 34. For Explanation of Finish Symbols see page 609.

BONDI—Fig. 13, page 957, . . . . . Key Plates only.

CHATILLON—Fig. 1, page 536, . . . . . 14 pieces, including

Esc'n Plates and Knobs, . . . . .	p. 536	Lever Handles, . . . . .	p. 879
Cup Escutcheons, . . . . .	" 904	Drawer Pulls, . . . . .	" 926
Cylinder Faces, . . . . .	" 924	Push Buttons, . . . . .	" 895
Flush Sash Lifts, . . . . .	" 916*	Push Plates, . . . . .	" 923*
Espagnolette Bars, . . . . .	" 888	Key Plates, . . . . .	" 953
Cremorne Bolts, . . . . .	" 887		

Appropriate Finishes: Brass (AZ15) Mult'r 3.9; Silver (SY52) Mult'r 4.5, (SY55) Mult'r 5.2; Gold (GZ10) Mult'r 10.4; Hand Chasing, Mult'r 1.5 additional.

COMPIEGNE—Fig. 5, page 536, . . . . . 47 pieces, including

Esc'n Plates and Knobs, . . . . .	p. 536	Door Pulls, . . . . .	p. 824
Cup Escutcheons, . . . . .	" 905	Push Buttons, . . . . .	" 895
Flush Sash Lifts, . . . . .	" 916*	Push Plates, . . . . .	" 923*

Appropriate Finishes: Brass (AY22) Mult'r 3.2; Copper (CY22) Mult'r 3.2; Silver (SY52) Mult'r 4.; Gold (GY10) Mult'r 12.6; Hand Chasing, Mult'r 1.4 additional.

MEAUX—Figs. 9 and 12, page 536, . . . . . 41 pieces, including

Esc'n Plates and Knobs, . . . . .	p. 536	Door Pulls, . . . . .	p. 826
Cup Escutcheons, . . . . .	" 905	Push Buttons, . . . . .	" 896
Flush Sash Lifts, . . . . .	" 916*	Push Plates, . . . . .	" 923*
Drawer Pulls, . . . . .	" 927		

Appropriate Finishes: Copper (CY22) Mult'r 2.7; Brass (AZ15) Mult'r 2.7; Silver (SY52) Mult'r 3.3, (SY55) Mult'r 4.; Gold (GY10) Mult'r 10.

MONCEAUX—Fig. 8, page 758, . . . . . 3 pieces, including

Store Door Handles, . . . . .	p. 759	Push Buttons, . . . . .	p. †
-------------------------------	--------	-------------------------	------

Appropriate Finishes: Bronze (BZ10) Mult'r 1.1; Copper (CY22) Mult'r 1.25; Silver (SY52) Mult'r 1.5; Gold (GY10) Mult'r 6.6; Iron (FX80) Mult'r .95

ST. MALO—Figs. 2, 3, 4, 6 and 8, page 536, 14 pieces, including

Esc'n Plates and Knobs, . . . . .	p. 536	Flush Sash Lifts, . . . . .	p. 916*
Cup Escutcheons, . . . . .	" 906	Push Buttons, . . . . .	" 897

Appropriate Finishes: Copper (CY22) Mult'r 2.4; Silver (SX52) Mult'r 2.9, (SY55) Mult'r 3.3; Gold (GZ10) Mult'r 8.5

TRIANON—Fig. 11, page 536, . . . . . 49 pieces, including

Esc'n Plates and Knobs, . . . . .	p. 536	Extension Bolts, . . . . .	p. 894*
Store Door Handles, . . . . .	" 757	Lever Handles, . . . . .	" 879
Cup Escutcheons, . . . . .	" 906	Door Pulls, . . . . .	" 829
Cylinder Faces, . . . . .	" 924	Push Buttons, . . . . .	" 897
Flush Sash Lifts, . . . . .	" 916*	Push Plates, . . . . .	" 923*
Bar Sash Lifts, . . . . .	" †	Shutter Trim, Figs. 7&10	" 922
Letter Drop Plates, . . . . .	" 917*	Cabinet Trim, . . . . .	" 922c

Appropriate Finishes: Brass (AY22) Mult'r 2.9; Copper (CY22) Mult'r 2.9; Silver (SY52) Mult'r 3.7, (SY55) Mult'r 4.3; Gold (GY10) Mult'r 11.2; Hand Chasing, Mult'r .5 additional.

VARENNES—Fig. 10, p. 530, & Fig. 8, p. 756, S. D. H'dle only.

VERDUN—Fig. 7, page 536, . . . . . Lever Handle only.

\*A few Designs only are shown as examples. †Not illustrated.

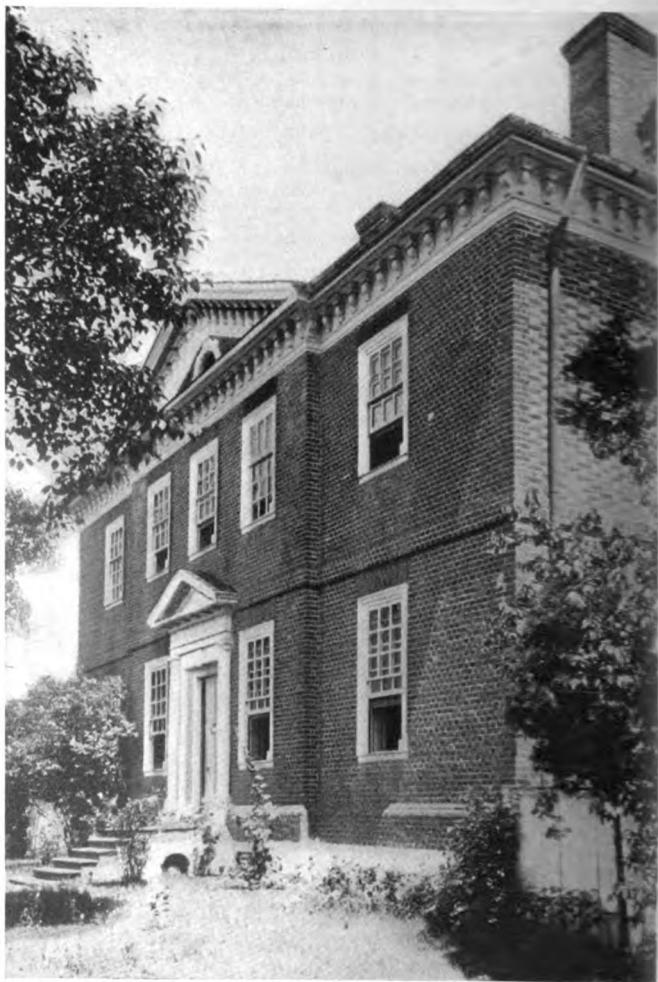
**House at Annapolis.**

## Colonial.

Jefferson, Bulfinch, Latrobe and others, 1634 to 1815.



**I**NHERITED through English and French traditions, America possesses a school of architecture and ornament derived from the Italian Renaissance. To this we have given the name Colonial, developed as it was, beginning in 1634 and lasting up to 1815, during our Colonial existence and for a period thereafter. The North and South are still possessed of nu-





Doorway, Annapolis, Md.

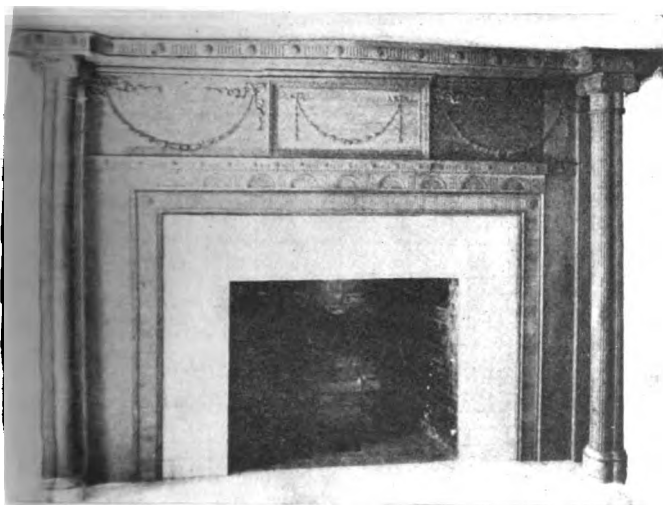

Mantel.

merous examples of the style in the old farmhouses and manors of New England and of the Middle and Southern states. The best examples were produced after 1730.

The school is a perfectly evident growth from the Italian Renaissance with constant retrospection toward classic art and side glances toward the Rococo, and an occasional original treatment of classic forms, prompted or necessitated by existing conditions. Its general characteristics are much the same as those of its Italian original. The acanthus is used in rude and also well modeled forms, and the scallop shell is of common

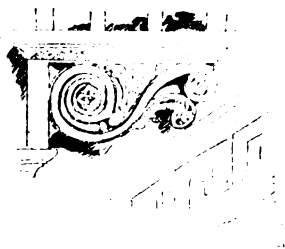

Ornament on end of Step.





Knocker.

occurrence with a profusion of dentils, bead and shuttle, egg and dart, and Greek fret or Roman key mouldings, bands, fillets, etc.

The application of the ornament varies widely. Sometimes we see it in profuse richness, and sometimes used sparingly with plain surfaces as better became Puritan tastes. The Southern Colonial ornament is Rococo in some cases, especially in the details of foliage, and the same is true of the many Northern examples. The town of Annapolis is full of exquisite Colonial ornament, and the Phillips Manor House at Yonkers, N. Y., is an extremely interesting Colonial dwelling, with decided Rococo ornament in several parts of the interior.

As applied to metal work, we find few genuinely old exam-

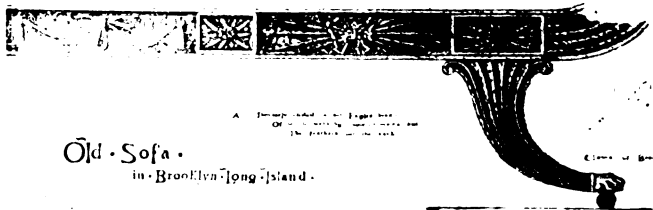
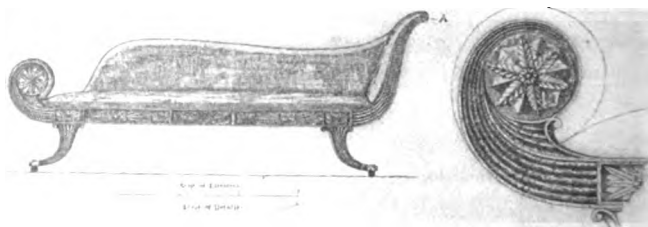

Old Sofa.

in Brooklyn Island.

A. Design of the Sofa  
 of the same by the same  
 the artist of the work

© 1880 of the



Mantel.

ples which are much ornamented. Andirons and knockers are generally plain, with only occasionally beads and frets. The old Franklin stoves are often embellished with cast bas-reliefs in iron or brass, and a few of the knockers are in the form of garlands with ribbons or Greek vases somewhat distorted to do service in peculiar forms. In most cases, however, the metal work of the Colonial houses is very simple, the surfaces being of plain polished brass, and the edges only ornamented with some of the characteristic fretwork. Where much ornament is found it is usually adapted from earlier Renaissance examples.

The Georgian, or most correct period of Colonial, began early in the reign of George III. Inigo Jones, Sir Christopher Wren and others had previously followed the precepts of Palladio and other masters, and many famous Italians had already designed important buildings in England, whence the style quickly spread to the English Colonies in America.

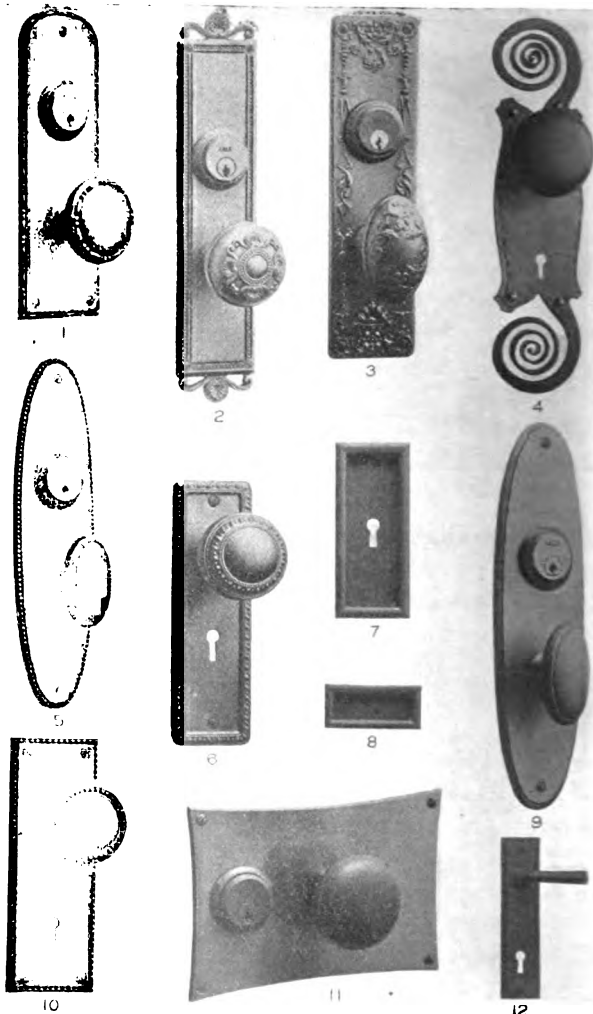

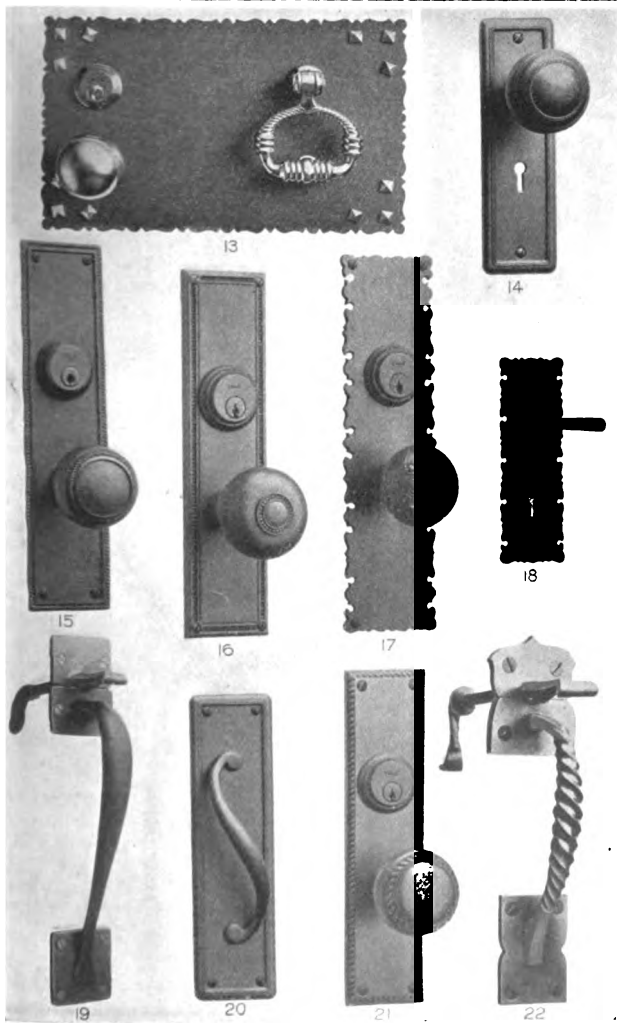



23



24



25



26



27



28



29



30



31



32



33



34



35



36



38



39



40



41



42



43



44



45



46



47



48



49



50

School—Colonial.

## Yale &amp; Towne Designs.

## Colonial.

The Multipliers indicate the relative prices of the various Designs and finishes as compared with prices of corresponding pieces in the Cluny Design, Copper Finish (CX22), pages 734 and 735. For Explanation of Multipliers see page 34. For Explanation of Finish Symbols see page 609.

ADAMS—Fig. 4, page 544, . . . . . 23 pieces, including  
 Esc'n Plates and Knobs, p. 544 . . . . . Bell Pulls, . . . p. †  
 Store Door Handles, . . " 745 . . . . . Push Buttons, . . " 895  
 Cup Escutcheons, . . " 904 . . . . . Push Plates, . . " 923\*  
 Door Pulls, . . . . " 823 . . . . . Hinge Plates, . . " 847  
 Door Knockers, . . . " 873 . . . . . Cabinet Trim, . . " 963  
 Appropriate Finishes: Bronze (BZ10) Mult'r 7.5; Copper (CX22)  
 Mult'r 7.6; Iron (FX80) Mult'r 5.

AMHERST—Fig. 2, page 544, . . . . . 48 pieces, including  
 Esc'n Plates and Knobs, p. 544 . . . . . Door Pulls, . . . p. 823  
 Cup Escutcheons, . . " 904 . . . . . Bell Pulls, . . . " †  
 Flush Sash Lifts, . . . " 916 . . . . . Push Buttons, . . " 895  
 Bar Sash Lifts, . . . . " † . . . . . Push Plates, . . " 923\*  
 Letter Drop Plates, . . " 917\* . . . . . Hinge Straps, . . " 847  
 Extension Bolts, . . . " 894\* . . . . . Cabinet Trim, . . " 964  
 Lever Handles, . . . . " 879  
 Appropriate Finishes: Bronze (BZ10) Mult'r 2.75; Copper (CY22)  
 Mult'r 2.8; Brass (AY22) Mult'r 2.8; Silver (SY52) Mult'r 3.4;  
 Gold (GY10) Mult'r 8.9; Hand Chasing, Mult'r .85 additional.

ANDOVER—Fig. 4, page 874, . . . . . Door Knocker only.

ANNAPOLIS—Page 964, . . . . . Cabinet Trim only.

ARCADIAN—Fig. 3, page 544, . . . . . 48 pieces, including  
 Esc'n Plates and Knobs, p. 544 . . . . . Door Pulls, . . . p. 823  
 Store Door Handles, . . " 759 . . . . . Bell Pulls, . . . " †  
 Cup Escutcheons, . . " 904 . . . . . Push Buttons, . . " 895  
 Flush Sash Lifts, . . . " 916\* . . . . . Push Plates, . . " 923\*  
 Drawer Pulls, . . . . " 925 . . . . . Key Plates, . . . " 952  
 Appropriate Finish: Copper (CX22 or CX17) Mult'r .3

ARLINGTON—Fig. 1, page 544, . . . . . 46 pieces, including  
 Esc'n Plates and Knobs, p. 544 . . . . . Bell Pulls, . . . p. †  
 Store Door Handles, . . " 745 . . . . . Push Buttons, . . " 895  
 Cup Escutcheons, . . " 904 . . . . . Push Plates, . . " 923\*  
 Flush Sash Lifts, . . . " 916\* . . . . . Shutter Trim, . . " 922\*  
 Bar Sash Lifts, . . . . " † . . . . . Key Plates, . . . " 952  
 Door Pulls, . . . . . " 823  
 Appropriate Finishes: Brass (AZ10) Mult'r 1., (AY22) Mult'r 1.1;  
 Bronze (BZ10) Mult'r 1.; Copper (CY22) Mult'r 1.1, (CX22)  
 Mult'r 1.1; Silver (SY52) Mult'r 1.6

AUBIN—Figs. 1 to 10, page 973, . . . . . Cabinet Trim only.

- BEVERLY**—Figs. 1 to 5, page 976, . . . Cabinet Trim only.
- BOTHNIAN**—Fig. 6, page 544, . . . 27 pieces, including
- |                                |                      |
|--------------------------------|----------------------|
| Esc'n Plates and Knobs, p. 544 | Push Buttons, p. 895 |
| Cup Escutcheons, . . . " 904   | Push Plates, " 923*  |
| Flush Sash Lifts, . . . " 916* | Key Plates, " 952    |
| Door Pulls, . . . " 824        |                      |
- Appropriate Finishes: Brass (AY22) Mult'r .3; Copper (CX22) Mult'r .3
- BOURG**—Figs. 52 & 54, p. 861, Drawer Pulls & Hinge Plates only
- BOYLSTON**—Fig. 17, page 957, . . . Key Plate only.
- BRISTOL**—Fig. 5, page 544, . . . 85 pieces, including
- |                                     |                       |
|-------------------------------------|-----------------------|
| Esc'n Plates and Knobs, p. 544      | Flush Bolts, . p. †   |
| Store Door Handles, . . . " 759     | Door Pulls, . " 824   |
| Cup Escutcheons, . . . " 904        | Hing Plates, . " 849  |
| Cylinder Faces, Fig. 6, . . . " 924 | Push Buttons, . " 895 |
| Flush Sash Lifts, . . . " 916*      | Push Plates, . " 923* |
| Letter Drop Plates, . . . " 917*    | Shutter Knobs, " 940  |
| Extension Bolts, . . . " 894*       | Cabinet Trim, " 965   |
- Appropriate Finishes: Bronze (BZ10) Mult'r .9; Brass (AZ10) Mult'r .9, (AY22) Mult'r 1.; Copper (CX22) Mult'r 1.; Silver (SY52) Mult'r 1.7; Iron (FX80) Mult'r .7
- BROCKTON**—Page 966, . . . Cabinet Trim only.
- BRUNSWICK**—Fig. 8, page 746, . . . 7 pieces, including
- |                                |                           |
|--------------------------------|---------------------------|
| Esc'n Plates. . . . p. †       | Flush Sash Lifts, p. 916* |
| Store Door Handles . . . " 747 | Push Buttons, . " 895     |
| Cup Escutcheons, . . . " 904   |                           |
- Appropriate Finishes: Bronze (BZ10) Mult'r .9; Copper (CY22) Mult'r 1.
- BURLINGTON**—Figs. 7 and 8, page 544, . . . 3 pieces, including
- |                               |                            |
|-------------------------------|----------------------------|
| Cup Escutcheons, . . . p. 904 | Flush Sash Lifts, . p. 544 |
|-------------------------------|----------------------------|
- Appropriate Finishes: Brass (AZ10) Mult'r .9; Copper (CY22) Mult'r 1.1; Silver (SY52) Mult'r 1.4; Gold (GZ10) Mult'r 5.6
- CAMBRIDGE**—Figs. 76, 77, 79 & 81, p. 937A, Drawer Pulls only.
- CHESTER**—Fig. 9, page 544, . . . 50 pieces, including
- |                                |                       |
|--------------------------------|-----------------------|
| Esc'n Plates and Knobs, p. 544 | Hinge Plates, . p. †  |
| Cup Escutcheons, . . . " 904   | Push Buttons, . " 895 |
| Flush Sash Lifts, . . . " 916* | Push Plates, . " 923* |
| Flush Bolts, . . . . " †       | Cabinet Trim, . " 966 |
| Door Pulls, . . . . " 824      |                       |
- Appropriate Finishes: Brass (AZ10) Mult'r .9; Bronze (BZ10) Mult'r .9; Copper (CY22) Mult'r 1.; Silver (SY52) Mult'r 1.7; Iron (FX80) Mult'r .7

\* A few Designs only are shown as samples. † Not illustrated.



COHASSET—Fig. 25, page 957, . . . . Key Plate only.

COLONNA—Figs. 10 and 12, page 544. 74 pieces, including

Esc'n Plates and Knobs, p. 544	Door Pulls, . . p. 824
Store Door Handles, . . " 749	Sash Sockets, . . " †
Cup Escutcheons, . . " 904	Push Buttons, . . " 895
Cylinder Faces, Fig. 3, . . " 924	Push Plates, . . " 923*
Flush Sash Lifts, . . . " 916*	Shutter Knobs, . . " 940
Letter Drop Plates, . . . " 917*	Cabinet Trim, . . " 966
Lever Handles, . . . . " 879	
Appropriate Finishes: Bronze (BZ10) Mult'r .9; Copper (CY22) Mult'r 1.; Silver (SY52) Mult'r 1.5; Iron (FX80) Mult'r .6	

CONCORD—Figs. 1 to 4, page 977, . . . Cabinet Trim only.

DEDHAM—Fig. 11, page 544, . . . . 18 pieces, including

Esc'n Plates and Knobs, p. 544	Push Buttons, . . p. 896
Cup Escutcheons, . . . " 905	Push Plates, . . " 923*
Flush Sash Lifts, . . . " 916*	Key Plates, . . . " 953
Drawer Pulls, . . . . " 926	
Appropriate Finishes: Bronze (BZ10) Mult'r 1.3; Brass (AZ10) Mult'r 1.3; Copper (CY22) Mult'r 1.4; Silver (SX52) Mult'r 1.8; Gold (GY10) Mult'r 6.6; Iron (FX80) Mult'r 1.	

DEERFIELD—Fig. 13, page 545, . . . . 8 pieces, including

Esc'n Plates & Knobs, p. 545	Esc'n Plates & Knock-
Push Buttons, . . . " 896	ers, . . . . p. 545
Appropriate Finishes: Brass (AZ10) Mult'r 1.8, (AY22) Mult'r 2.; Iron (FX80) Mult'r 1.6 (Escutcheon Plates with Knockers not included).	

DERBY—Page 967, . . . . . Cabinet Trim only.

DORCHESTER—Fig. 15, page 545, . . . . 45 pieces, including

Esc'n Plates and Knobs . . p. 545	Push Buttons, . . p. 896
Cup Escutcheons, . . . " 905	Push Plates, . . . " 923*
Flush Sash Lifts, . . . . " 916*	Shutter Knobs, . . . " 940
Door Pulls, . . . . . " 825	Key Plates, . . . . " 953
Appropriate Finishes: Bronze (BZ10) Mult'r 1.1; Copper (CY22) Mult'r 1.2; Brass (AZ15) Mult'r 1.2; Silver (SY52) Mult'r 1.7; Iron (FX80) Mult'r .85	

\*A few Designs only are shown as examples. † Not illustrated.

- ORIAN**—Fig. 14, page 545, . . . . . 32 pieces, including  
 Esc'n Plates and Knobs, . p. 545      Push Buttons, . . p. 896  
 Cup Escutcheons, . . " 905      Push Plates, . . " 923\*  
 Flush Sash Lifts, . . . " 916\*      Key Plates, . . . " 953  
 Door Pulls, . . . . " 825  
 Appropriate Finishes: Brass (AY22) Mult'r .3; Copper (CX22)  
 Mult'r .3
- OVER**—Fig. 39, page 958, . . . . . Key Plate only.
- PETER**—Fig. 75, page 937, . . . . . Drawer Pulls only.
- RAIFAX**—Fig. 16, page 545, . . . . . 70 pieces, including  
 Esc'n Plates and Knobs, . p. 545      Extension Bolts, . p. 894\*  
 Store Door Handles, . . " 749      Cremorne Bolts, . " 887  
 Cup Escutcheons, . . . " 905      Door Pulls, . . . " 825  
 Flush Sash Lifts, . . . " 916\*      Bell Pulls, . . . " †  
 Hook Sash Lifts, . . . " †      Push Buttons, . . . " 896  
 Bar Sash Lifts, . . . . " †      Push Plates, . . . " 923\*  
 Sash Sockets, . . . . " †      Shutter Trim, . . . " 922\*  
 Sash Fast, . . . . . " †      Cabinet Trim, . . . " 967  
 Appropriate Finishes: Brass (AZ10) Mult'r 2.5; Bronze (BZ10)  
 Mult'r 2.5; Copper (CY22) Mult'r 2.6; Silver (SY52) Mult'r 3.2;  
 Gold (GY10) Mult'r 9.; Hand Chasing. Mult'r .5 additional.
- GERMANTOWN**—Fig. 50, page 958, . . . . . Key Plate only.
- GUILFORD**—Figs. 17 and 18, page 545, . . . . . 40 pieces, including  
 Esc'n Plates and Knobs, . p. 545      Door Pulls, . . . p. 825  
 Cup Escutcheons, . . . " 905      Push Buttons, . . . " 896  
 Flush Sash Lifts, . . . " 916\*      Push Plates, . . . " 923\*  
 Appropriate Finishes: Brass (AZ10) Mult'r 1.2; Copper (CY22)  
 Mult'r 1.3
- HADLEY**—Fig. 19, page 545, . . . . . Lift Latch only.
- HARTFORD**—Fig. 50, page 935, . . . . . Drawer Pull only.
- HELLENIAN**—Fig. 23, page 546, . . . . . 58 pieces, including  
 Esc'n Plates and Knobs, . p. 546      Door Pulls, . . . p. 826  
 Store Door Handles, . . " 759      Push Buttons, . . . " 896  
 Cup Escutcheons, . . . " 905      Push Plates, . . . " 923\*  
 Flush Sash Lifts, . . . " 916\*      Shutter Knobs, . . " 940  
 Letter Drop Plates, . . . " 917\*      Cabinet Trim, . . . " 969  
 Extension Bolts, . . . . " 894\*  
 Appropriate Finishes: Brass (AZ10) Mult'r .35; Copper (CZ17)  
 Mult'r .35; Silver (SY52) Mult'r .8

\* A few Designs only are shown as examples. † Not illustrated.

### HINGHAM—Fig. 21, page 545, . . . 83 pieces, including

Esc'n Plates and Knobs, p. 545	Sash Sockets, . . . . . p. †
Store Door Handles, . . . " 751	Door Pulls, . . . . . " 826
Cup Escutcheons, . . . " 905	Bell Pulls, . . . . . " †
Flush Sash Lifts, . . . " 916*	Push Buttons, . . . . . " 896
Hook Sash Lifts, . . . " †	Push Plates, . . . . . " 923*
Bar Sash Lifts, . . . " †	Hinge Plates, . . . . . " 851
Letter Drop Plates, . . . " 917*	Shutter Trim, . . . . . " 922*
Extension Bolts, Fig. 5 . . . " 894	Cabinet Trim, . . . . . " 969

Appropriate Finishes: Bronze (BZ10) Mult'r 1.; Copper (CY22) Mult'r 1.1; Brass (AY22) Mult'r 1.1; Silver (SY52) Mult'r 1.5; Gold (GZ10) Mult'r 6.7; Iron (FX80) Mult'r .75

### IONIAN—Fig. 26, page 546, . . . 51 pieces, including

Esc'n Plates and Knobs, p. 546	Door Pulls, . . . . . p. 826
Store Door Handles, . . . " 759	Push Buttons, . . . . . " 896
Cup Escutcheons, . . . " 905	Push Plates, . . . . . " 923*
Flush Sash Lifts, . . . " 916*	Shutter Knobs, . . . . . " 940
Letter Drop Plates . . . " 917*	Cabinet Trim, . . . . . " 969
Extension Bolts, . . . . . " 894*	

Appropriate Finishes: Brass (AZ10) Mult'r .35; Copper (CZ17) Mult'r .35; Silver (SY52) Mult'r .8

### IPSWICH—Fig. 22, page 545, . . . . Lift Latch only.

### IRUNO—Figs. 24 and 25, page 546, . . 34 pieces, including

Esc'n Plates and Knobs, p. 546	Push Buttons, . . . . . p. 896
Cup Escutcheons, . . . " 905	Push Plates, Fig. 8, . . . " 923
Flush Sash Lifts, . . . " 916*	Shutter Knobs, . . . . . " 940
Hook Sash Lifts, . . . " †	Cabinet Trim, . . . . . " 969

Appropriate Finishes: Bronze (BZ10) Mult'r .75; Copper (CZ17) Mult'r .75

### JAMESTOWN—Figs. 27, 28 & 30, page 546, 28 pieces, including

Esc'n Plates and Knobs, p. 546	Door Pulls, . . . . . p. 826
Cup Escutcheons, . . . " 905	Push Buttons, . . . . . " 896
Flush Sash Lifts, Fig. 6, " 916*	Push Plates, . . . . . " 923*
Drawer Pulls, . . . . . " 927	Key Plates, . . . . . " 954

Appropriate Finishes: Brass (AZ10) Mult'r 1.8; Bronze (BZ10) Mult'r 1.8; Copper (CX22) Mult'r 2.; Iron (FX80) Mult'r .85

### JENNICO—Fig. 29, page 546, . . . 24 pieces, including

Esc'n Plates and Knobs, p. 546	Extension Bolts, . . . . . p. 894*
Cup Escutcheons, . . . " 905	Door Pulls, . . . . . " 826
Flush Sash Lifts, . . . " 916*	Push Buttons, . . . . . " 896
Hook Sash Lifts, . . . " †	Push Plates, . . . . . " 923*
Letter Drop Plates, . . . " 917*	Cabinet Trim, . . . . . " 970

Appropriate Finishes: Brass Plated (FAY22) Mult'r .25; Bronze Plated (FBZ10) Mult'r .25; Copper Plated (FCZ17 or FCX17) Mult'r .25

\* A few Designs only are shown as examples. † Not illustrated.

LEXINGTON—Figs. 1 to 5, page 985, . . . Cabinet Trim only.

LOUISBURG—Fig. 66, page 959, . . . Key Plate only.

LOWELL—Page 971, . . . Cabinet Trim only.

LYNN—Fig. 31, page 546, . . . 75 pieces, including

Esc'n Plates and Knobs, p. 546	Extension Bolts, Fig. 4, p. 894
Store Door Handles, . . . " 753	Door Pulls, . . . " 826
Cup Escutcheons, . . . " 905	Push Buttons, . . . " 896
Flush Sash Lifts, . . . " 916*	Push Plates, . . . " 923*
Bar Sash Lifts, . . . " †	Shutter Trim, . . . " 922*
Letter Drop Plates, . . . " 917*	Cabinet Trim, . . . " 971

Appropriate Finishes: Bronze (BZ10) Mult'r .95; Brass (AY22) Mult'r 1.; Copper (CX22) Mult'r 1.; Silver (SX52) Mult'r 1.5; Gold (GX10) Mult'r 6.4; Iron (FX80) Mult'r .6

MANHATTAN—Fig. 72, page 959, . . . Key Plate only.

MANSFIELD—Fig. 73, page 959, . . . Key Plate only.

MEDFORD—Figs. 32, 33 and 34, page 546, 39 pieces, including

Esc'n Plates and Knobs, p. 546	Push Buttons, . . . p. 896
Cup Escutcheons, . . . " 905	Push Plates, . . . " 923*
Flush Sash Lifts, . . . " 916*	Cabinet Trim, . . . " 972
Door Pulls, . . . " 326	

Appropriate Finishes: Brass (AZ10) Mult'r 1.3; Copper (CX22) Mult'r 1.4; Silver (SX52) Mult'r 1.9; Iron (FX80) Mult'r .8

MIDDLESEX—Fig. 35, page 547, . . . 44 pieces, including

Esc'n Plates and Knobs, p. 547	Door Pulls, . . . p. 827
Cup Escutcheons, . . . " 905	Push Buttons, . . . " 896
Flush Sash Lifts, . . . " 916*	Push Plates, Fig. 5, . . . " 923

Appropriate Finishes: Bronze (BZ10) Mult'r 2.9; Copper (CX22) Mult'r 3.; Silver (SY10) Mult'r 4.; Gold (GY10) Mult'r 8.4; Iron (FX80) Mult'r .75

NAHANT—Fig. 99, page 866, . . . Hinge Straps only.

NANTUCKET—Figs. 37, 38, 39, page 547, 4 pieces, including

Cup Escutcheons with Drop Handles, . . . p. 906	Knobs and Roses, . . . p. 547
	Key Plates, . . . " 955

Appropriate Finishes: Bronze (BZ10) Mult'r 3.25; Copper (CY22) Mult'r 3.4; Silver (SY52) Mult'r 4.; Gold (GY10) Mult'r 12.5

PETERSHAM—Page 972A, . . . Cabinet Trim only.

PIEDMONT—Fig. 2, page 594A, . . . 53 pieces, including

Esc'n Plates and Knobs, p. 594A	Push Buttons, . . . p. 897
Cup Escutcheons, . . . " 906	Push Plates, . . . " 923*
Store Door Handles, . . . " †	Shutter Knobs, . . . " 941
Flush Sash Lifts, . . . " 916*	Cabinet Trim, . . . " 972A
Door Pulls, . . . " 827	

Appropriate Finishes: Brass (AZ10) Mult'r .9; Bronze (BZ10) Mult'r .9; Copper (CY22) Mult'r 1., (CX22) Mult'r 1.; Silver (SY52) Mult'r 1.5; Iron (FX80) Mult'r .7

\* A few Designs only are shown as examples. † Not illustrated.

**PLYMOUTH**—Fig. 36, page 547, . . . 74 pieces, including

Esc'n Plates and Knobs, . . . p. 547	Door Pulls, . . . . . p. 828
Store Door Handles, . . . " 755	Bell Pulls, . . . . . " +
Cup Escutcheons, . . . " 906	Hinge Plates, . . . . . " 853
Flush Sash Lifts, . . . " 916*	Corner Plates, . . . . . " 853
Bar Sash Lifts, . . . . . " †	Push Buttons, . . . . . " 897
Letter Drop Plates, . . . " 917*	Push Plates, . . . . . " 923*
Extension Bolts, Fig. 1, . . . " 894	Shutter Knobs, . . . . . " 941
Sash Sockets, . . . . . " †	Cabinet Trim, . . . . . " 972B
Door Knockers, . . . . . " 873	

Appropriate Finishes: Brass (AZ10) Mult'r 1.1, (AY22) Mult'r 1.2; Silver (SY2) Mult'r 1.7; Iron (FX80) Mult'r .8

**PORTSMOUTH**—Fig. 92, page 937B, . . . Drawer Pulls only**PUTNAM**—Fig. 65, page 936, . . . Drawer Pulls only**REVERE**—Figs. 43 and 45, page 931, . . . Drawer Pulls only**ROANOKE**—Fig. 40, page 547, . . . 45 pieces, including

Esc'n Plates and Knobs, p. 547	Bell Pulls, . . . . . p. +
Store Door Handles, . . . " 755	Hinge Plates, . . . . . " 853
Cup Escutcheons, . . . " 906	Push Buttons, . . . . . " 897
Flush Sash Lifts, . . . " 916*	Push Plates, . . . . . " 923*
Extension Bolts, . . . " 894*	Cabinet Trim, . . . . . " 972B
Door Pulls, . . . . . " 828	

Appropriate Finishes: Brass (AZ10) Mult'r 1.4, (AY22) Mult'r 1.5; Copper (CX22) Mult'r 1.5; Iron (FX80) Mult'r 1.2

**SALEM**—Fig. 44, page 547, . . . 64 pieces, including

Esc'n Plates and Knobs, p. 547	Door Pulls, . . . . . p. 828
Store Door Handles, . . . " 755	Bell Pulls, . . . . . " +
Cup Escutcheons, . . . " 906	Push Buttons, . . . . . " 897
Flush Sash Lifts, . . . " 916*	Push Plates, . . . . . " 923*
Bar Sash Lifts, . . . . . " †	Shutter Trim, . . . . . " 923*
Extension Bolts, . . . . . " 894*	Cabinet Trim, . . . . . " 972B
Sash Sockets, . . . . . " †	

Appropriate Finishes: Brass (AZ10) Mult'r 1.6, (AY22) Mult'r 1.7; Copper (CY22) Mult'r 1.7; (CX22) Mult'r 1.7

**SAYBROOK**—Fig. 93, page 960, . . . Key Plate only.**SENTIS**—Fig. 41, page 547, . . . 6 pieces, including

Esc'n Plates and Knobs, p. 547  
 Appropriate Finishes: Bronze (BZ10) Mult'r 1.; Copper (CX22) Mult'r 1.1; Silver (SX52) Mult'r 1.6; Gold (GX10) Mult'r 6.2; Iron (FX80) Mult'r .8

**SPARTA**—Fig. 43, 547, . . . 61 pieces, including

Esc'n Plates and Knobs, p. 547	Extension Bolts, . . . . . p. 894*
Store Door Handles, . . . " 755	Door Pulls, . . . . . " 829
Cup Escutcheons, . . . " 906	Push Buttons, . . . . . " 897
Flush Sash Lifts, . . . " 916*	Push Plates, . . . . . " 923*
Bar Sash Lifts, . . . . . " †	Cabinet Trim, . . . . . " 972B
Letter Drop Plates, . . . " 917*	

Appropriate Finishes: Bronze (BZ10) Mult'r 1.1; Brass (AY22) Mult'r 1.2; Copper (CY22) Mult'r 1.2; Silver (SY52) Mult'r 1.8; Gold (GY10) Mult'r 8.; Iron (FX80) Mult'r .8.

\* A few Designs only are shown as examples. † Not illustrated.

- STONINGTON**—Fig. 3, page 594A. . . . 35 pieces, including  
 Esc'n Plates and Knobs, p. 594A      Push Plates, . . . . p. 923\*  
 Bar Sash Lifts, . . . " †      Pull Plates, . . . . " †  
 Letter Drop Plates, . . . " 917\*      Key Plates, . . . . " 955  
 Door Pulls, . . . . " 829
- Appropriate Finishes: Bronze (BZ10) Mult'r .65; Copper (CY22) Mult'r .7; (CX22) Mult'r .75; Silver (SY52) Mult'r 1.2; Iron (FX80) Mult'r .5
- STRABO**—Fig. 96, page 960, . . . . Key Plates only.
- TOULON**—Figs. 1 to 8, page 990, . . . Cabinet Trim only.
- TRAVES**—Figs. 1 to 8, page 991, . . . Cabinet Trim only.
- TRENTO**—Fig. 6, page 874, . . . . Door Knocker only.
- TRENTON**—Fig. 103, page 960, . . . Key Plates only.
- VANCLUSE**—Fig. 49, page 861, . . . Hinge Plates only.
- VIGNORY**—Fig. 17, page 857, . . . Hinge Plates only.
- WARREN**—Figs. 44 and 46, page 934, . . . Drawer Pulls only.
- WEYMOUTH**—Fig. 48, page 547, . . . 14 pieces, including  
 Esc'n Plates and Knobs, p. 547      Push Plates, . . . . p. 923\*  
 Cup Escutcheons, . . . " 906      Cabinet Trim, . . . " 972D  
 Flush Sash Lifts, . . . " 916\*
- Appropriate Finishes: Brass (AZ10) Mult'r 1.9; Copper (CY22) Mult'r 2.; Silver (SY52) Mult'r 2.3; Gold (GY10) Mult'r 6.; Iron (FX80) Mult'r 1.1
- WILTON**—Figs. 49 and 50, page 547, . . . 7 pieces, including  
 Knobs and Roses, . . . p. 547      Push Buttons, . . . . p. 897  
 Cylinder Roses, . . . " 547      Key Plates, . . . . " 956
- Appropriate Finishes: Brass (AZ10) Mult'r 2.6, (AY22) Mult'r 2.7; Copper (CX22) 2.7; Silver (SY52) Mult'r 3.5; Iron (FX80) Mult'r 1.9
- WOBURN**—Figs. 46 and 47, page 547. . . 11 pieces, including  
 Knobs and Roses, . . . p. †      Shutter Knobs, . . . . p. 941  
 Cup Escutcheons, . . . " 906      Cabinet Trim, . . . . " 972D  
 Flush Sash Lifts, Fig. 47 " 547
- Appropriate Finishes: Brass (AZ10) Mult'r 2.6, (AY22) Mult'r 2.8; Silver (SY52) Mult'r 3.; Gold (GY10) Mult'r 8.5; Hand Chasing, Mult'r 1.4 additional.
- YORKTOWN**—Fig. 45, page 547, . . . 52 pieces, including  
 Esc'n Plates and Knobs, p. 547      Door Pulls, . . . . p. 829  
 Store Door Handles, . . . " †      Push Buttons, . . . . " 897  
 Cup Escutcheons, . . . " 906      Push Plates, . . . . " 923\*  
 Flush Sash Lifts, . . . " 916\*      Cabinet Trim, . . . . " 972D
- Appropriate Finishes: Brass (AZ10) Mult'r .9; Copper (CX22) Mult'r 1.; Silver (SY52) Mult'r 1.5; Gold (GY10) Mult'r 4.7; Iron (FX80) Mult'r .7

\*A few Designs only are shown as examples. † Not illustrated.



Bedroom of Napoleon, at Fontainebleau.



Bedroom of the Empress, at the Chateau of Compiègne.

## Empire.

Napoleon, born at Ajaccio in 1769. Died at St. Helena in 1821. Emperor from 1804 to 1814.

Percier and Fontaine have preserved the spirit of the First Empire in their "Style Empire" and other designers were Desmaller, Thomire and Biennais.

**A**FTER France had freed herself from the terrors of the Revolution by the death of Robespierre and the consequent subduing of the worst element of the populace by soldiery, the national mind, especially at Paris, began quickly to seek recreation and amusement in new and strange paths. The general transformation in all lines of thought expressed itself not

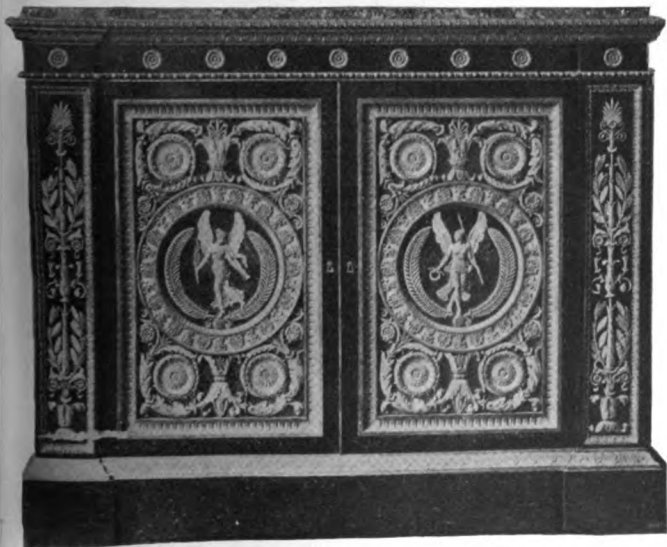

Front of Cabinet.



only in political and military matters, but also in all that pertained to social subjects. Both art and literature showed a decisive tendency toward a revival, or rather imitation of classical ideas, and the result was a style which, while strongly influenced by classical precedent, was sufficiently distinctive to be entitled to a name of its own.

By the time that Napoleon was at the helm in 1804 and the First Empire an established fact, not only had a sort of classic dress been adopted by the citizens, but France had taken upon herself the starting of a new school of ornament, which consisted in a return to classic forms with which were mingled the imperial insignia and such other emblems as the times suggested.



Table.



Pedestal  
for Candelabra.

The Bonaparte "B" is represented by a bee frequently occurring.

The ornament is generally made of ormolu which is fastened to the wood, or stone, or marble of the furniture to be ornamented.

The olive branch garland and wreath are used frequently and the ornament is often planned in panels. In brief, without adhering closely to classic precedent, the spirit of it is always suggested if not completely embodied. Delicacy is always a prevailing feature and rarely disregarded. A field is sometimes covered with a diaper pattern as background for a center piece, the fleur-de-lis being sometimes taken for repetition in the pattern.

The style of the First Empire resembles the Renaissance much in the same manner as did the Colonial style, and in fact both had their origin at periods not far apart, and the differences between them are mainly due to the influences of surroundings and of racial temperament.



1



2



3



4



7



5



6



8



9



10

## Yale &amp; Towne Designs. . . . Empire.

The Multipliers indicate the relative prices of the various Designs and finishes as compared with prices of corresponding pieces in the Cluny Design, Copper Finish (CX22), pages 734 and 735. For Explanation of Multipliers see page 34.

For Explanation of Finish Symbols see page 609.

## ARCOLA—Fig. 1, page 560, . . . . 5 pieces, including

Esc'n Plates and Knobs, p. 560	Flush Sash Lifts, . . . . p. 916*
Cup Escutcheons, . . . " 904	Door Pulls, . . . . " 823
Appropriate Finishes: Copper (CY22) Mult'r 4.5, (CX22) Mult'r 4.5; Silver (SX52) Mult'r 5.2, (SY55) Mult'r 6.; Gold (GY10) Mult'r 11.; Hand Chasing, Mult'r 1.6 additional.	

## AUSTERLITZ—Figs. 2 and 6, page 560 . . . 40 pieces, including

Esc'n Plates and Knobs, p. 560	Extension Bolts, . . . . p. 894*
Store Door Handles, . . . " 747	Door Pulls, . . . . " 823
Cup Escutcheons, . . . " 904	Push Buttons, . . . . " 895
Flush Sash Lifts, . . . " 916*	Push Plates, . . . . " 923*
Hook Sash Lifts, . . . " †	Shutter Trim, . . . . " 922*
Bar Sash Lifts, . . . . " †	Cabinet Trim, . . . . " 965
Appropriate Finishes: Brass (AZ15) Mult'r 1.5; Copper (CY22) Mult'r 1.5; (CX22) Mult'r 1.5; Silver (SX52) Mult'r 2.25, (SY55) Mult'r 3.1; Gold (GY10) Mult'r 9.75	

## JENA—Figs. 3, 4, and 5, page 560, . . . 11 pieces, including

Esc'n Plates and Knobs, p. 560	Door Pulls, . . . . p. 826
Store Door Handles, . . . " 751	Push Buttons, . . . . " 896
Cylinder Faces, Fig. 11, " 924	Push Plates, . . . . " 923*
Hinge Straps, . . . . " 851	
Appropriate Finishes: Brass (AZ10) Mult'r 1.8; Copper (CX22) Mult'r 1.9; Silver (SX52) Mult'r 2.8	

## MARENGO—Figs. 7 and 9, page 560 . . . 22 pieces, including

Esc'n Plates and Knobs, p. 560	Door Pulls, . . . . p. 826
Store Door Handles, . . . " 753	Push Buttons, . . . . " 896
Cup Escutcheons, . . . " 905	Push Plates, . . . . " 923*
Flush Sash Lifts, . . . . " 916*	
Appropriate Finishes: Brass (AZ15) Mult'r 1.5; Copper (CY22) Mult'r 1.5, (CX22) Mult'r 1.5; Silver (SX52) Mult'r 2.25, (SY55) Mult'r 3.1; Gold (GY10) Mult'r 8.75	

## NEMOURS—Fig. 8, page 560, . . . . 7 pieces, including

Esc'n Plates and Knobs, p. 560	Bar Sash Lifts, . . . . p. †
Store Door Handles, . . . " 760	Push Plates, . . . . " 923*
Appropriate Finish: Iron (FX80) Mult'r 1.6	

## ST. CLOUD—Fig. 10, page 560, . . . 39 pieces, including

Esc'n Plates and Knobs, p. 560	Door Pulls, . . . . p. 829
Cup Escutcheons, . . . " 906	Push Buttons, . . . . " 897
Flush Sash Lifts, . . . . " 916*	Push Plates, . . . . " 923*
Lever Handles, . . . . " †	Cabinet Trim, . . . . " 972c
Appropriate Finishes: Brass (AY22) Mult'r 3.25; Copper (CY22) Mult'r 3.25; Silver (SY52) Mult'r 4.2; Gold (GY12) Mult'r 12.5; Hand Chasing, Mult'r .85 additional.	

\*A few Designs only are shown as examples. † Not illustrated.



A Doorway.

## L'Art Nouveau.

the works of members of the Union Centrale des Arts Decoratifs de Paris, Rubrick Robert, Alexandre Charpentier, Vallgren, Dampf, Grasset and others in Paris. Victor Horta, Belgium, one of its greatest leaders. Van de Velde, (Germany), Colonna, Aubrey Beardsley, besides other noted continental artists.



At least an acquaintance with the art of the past has never before in the history of man been so accessible to every student as it is to-day. For not only he who runs may read, but even the loiterer can hardly escape, if he accepts the aid which printing, photography and the allied methods of reproduction

are constantly offering.

For the designer who applies ornaments to special objects as well as to the man who has occasion to use ornament in a more general way, as for instance in architecture, and in brief to anyone whose life brings him into critical contact with the art of ornamental design, there is a rule which may be set down as a safeguard in judging of its excellencies or faults, and that is, that nothing is good simply because it is done in a certain school or style. The Gothic school was eminently one of beautiful design, and the Rococo is noted for its lapses into almost imbecile oddities and self-conceits, yet it is not safe to say that Gothic designers did not nod and even fall asleep or that Rococo does not frequently show the flash and sparkle of astonishingly beautiful life and delicacy.



Card Tray.



Clock. The Flight of Time.  
By A. Charpentier.

its apparent origin was continental in location; first manifested in German, Hungarian and Austrian designs.

Its influence was quickly felt in France and but slowly in Italy which, as the latter is the very fortress of classic tradition, is not strange. Did the English Pre-Raphaelites anticipate it in their return to mediæval atmosphere? Was not a certain M. Colonna here in America one of its early disciples as evidenced by his decorative drawings, and did not Mr. Sullivan in

It is clear that our age is essentially eclectic; that from what has preceded we are slowly learning to take the wheat and leave the chaff, and where the door is so open we ought to feel that excellence should be the test of our work.

The past decade in Europe and America has seen a gradual but radical departure from recognized forms in architecture and decoration called by the French "L'Art Nouveau," and, as in all art development, it is almost impossible to say exactly when or where the first impulse was felt or put into execution, but briefly we may say that



Clock.  
Collection of S. Bing.

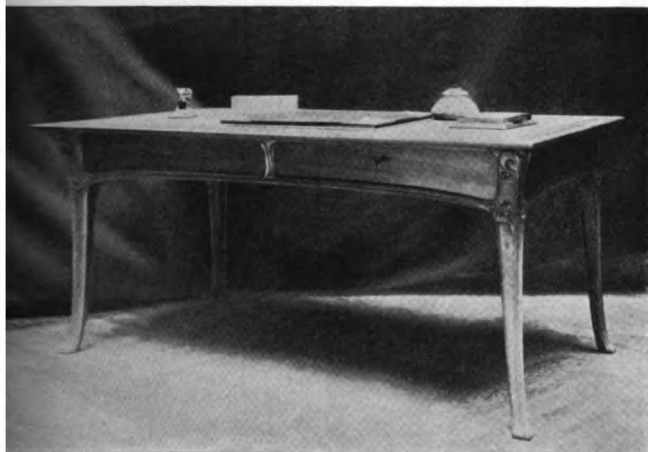

Table. Collection of S. Bing.

Chicago, basing his ornament on the prairie lotus and the Byzantine inspiration of the Richardsonian Romanesque revival give us here a hint of what was coming by his modern treatment of the acanthus?

Certainly Aubrey Beardsley and Will Bradley, Henry Linder the sculptor, and their American followers were walking in the paths of originality even though we all fancied we saw Japanese influence and the cloven hoof of the worship of mediævalism in their work, charming as much of it is. The rise of the "Poster" was, I believe, a great sign of the free thinking and drawing now upon us. France, to-day, is making the most of the new style, but it is chiefly in jewelry, bric-a-brac and furniture and the



Sconce. By Henry Linder





Compartment of Cupboard for  
Stringed Instruments.  
By Alexandre Charpentier.

Realism is its weakest phase and conventional treatment of swirling, almost Gothic, forms founded on the growth of plants is one of the best indications that in it we may yet find the starting point, at least, for a new school founded on nature. From Italy we may finally expect much, even if Italians do not, begin it on radically new lines.

ornament incidental thereto. So far architecture has not outside of Germany been even seriously affected by the change, and certainly, if it may be guided by the published examples, some German designers are doing their best to discourage the world of design, while those French men who are working in this vein are putting serious thought into their designs.

If, however, we mean to judge it by its results in the Paris Exposition of 1900, its effect on ornament is encouraging while in architecture it certainly blazes the path to decadence. In small articles and furniture it is cleverly handled by many little masters, but no new and impressive architectural thought has been interpreted by it either in plan or facade.



Sconce. By Henry Linder.

Classic tradition there will in all probability help rather than hinder its development in the restraint which it will naturally exercise upon it.

As to what forms of leaf or flower, and what contours should be studied for good results in ornamentation, we must go to nature, but neither try to lead nor surpass her in her own province, nor must we slavishly copy her, but rather by close study see how and why things are thus and so, and suggest in our work the inspiration which she can give. This *new art* may be able to do effectively.

Some of the best designs in older work lack decoration entirely. Take some of the early Greek tombs and we see as well in the contour of the canoe paddle or spear of the savage the value of pure unassisted outlines. Take the Colonial and Spanish metal work and some of it is perfectly plain, and yet its outlines are attractive because the curves are often beautiful in themselves, and often the proportions of length to breadth are well studied. If the "new" men can keep this in mind they cannot go far astray.

In all the endless discussion about excellence in design we are apt to lose sight of the fact that logical common sense plays a most important part. Not that this alone can carry away the laurel, but without it genius must often fail. In closing, it may not be inappropriate to quote the words of Henry Van Brunt, on architectural design :

Chair,  
Collection of S. Bing.



Sconce.  
By Henry Linder.

may leave behind us not anarchy and confusion, but discipline and order, adequately expressing the civilization of our times." This applies to all designers of ornament and architecture, and with special force to "L'Art Nouveau."

"The education of the modern architect would be justified if it had done nothing else than to put an end to the absurd 'battle of styles' which raged in England and America fifteen or twenty years ago. We are the legitimate heirs of all that has gone before us, and the great object of our education is to teach us to avoid a prodigal waste of our vast inheritance, and to use it with discretion and self-denial, that we, in our turn,

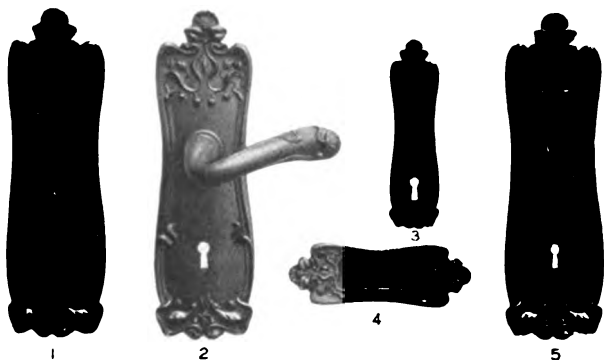

Yale &amp; Towne Designs.

L'Art Nouveau.

The Multipliers indicate the relative prices of the various finishes, as compared with prices of corresponding pieces in the Cluny Design, Copper Finish (CX22), pages 734 and 735. For Explanation of Multipliers see page 34.

For Explanation of Finish Symbols see page 609.

LAVAL—Figs. 1 to 5, above, . . . . 8 pieces, including

Esc'n Plates and Knobs, p. 569

Cup Escutcheons, . . . " 905

Flush Sash Lifts, Fig. 4, " 569

Lever Handles,

Fig. 2, . . . p. 569

Shutter Knobs, †

Appropriate Finishes: Brass (AZ10) Mult'r 2.9, (AZ15) Mult'r 3., (AZ61) Mult'r 3.6; Silver (SY55) Mult'r 4.4; Gold (GX12) Mult'r 10.7

† Not illustrated.

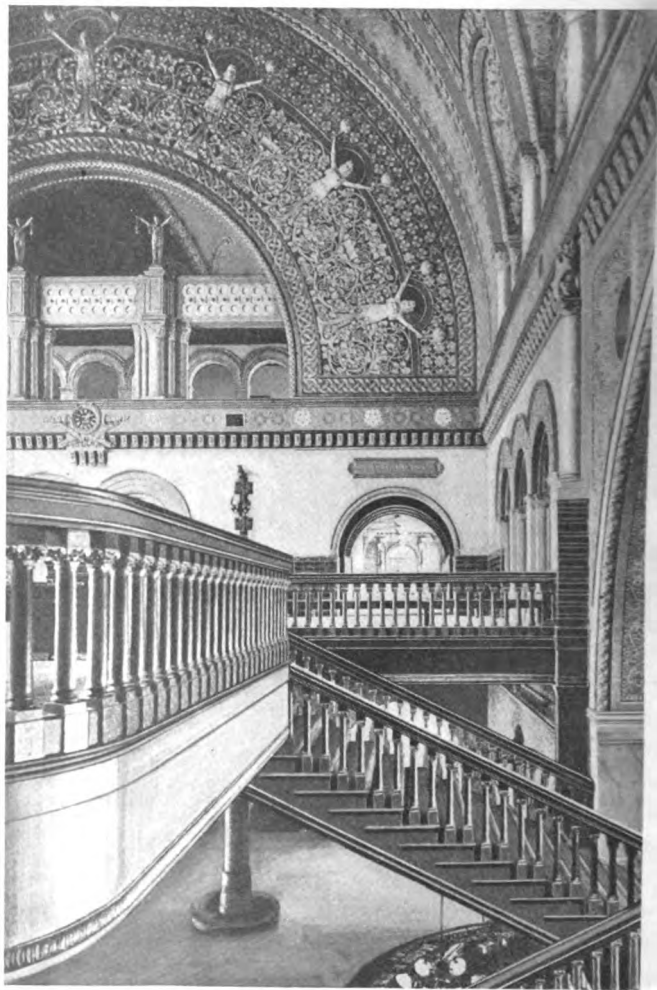

Union Passenger Station, St. Louis, Mo.

## Modern.



DECORATIVE art in the United States is showing to-day the effect of intelligent study of the past, adhering often to motives recognized as good, but striking out into new paths in the search for the ideal. We cannot claim a national style yet, inasmuch as the revivals of bygone styles have come and gone with such rapidity as to almost unsettle the designer, and many obstacles lie in the way of the adoption or creation of a national style.

Nevertheless, education is bearing and with the increase of wealth and culture since 1876, the progress in architecture and decoration has been surprising even those who expected it.

If we review the work of the foremost designers during the twenty-five years this view finds ample justification. Unquestionably among the designers of this period the late H. H. Richardson stands conspicuous, not only as an architect and soiling with entire structures, but also as a great student of the skill of decoration and color often so carefully, and always so finally and boldly applied in his work. In ornament, especially, Richardson struck for us a new note. He had an innate sense of the value of contrast and scale, and on his buildings the fanciful ornament leaning as it did toward the Byzantine in delicacy and richness was strikingly effective and harmonious. He applied his ornament to improve his designs and did not



Main Staircase, Public Library, Chicago.

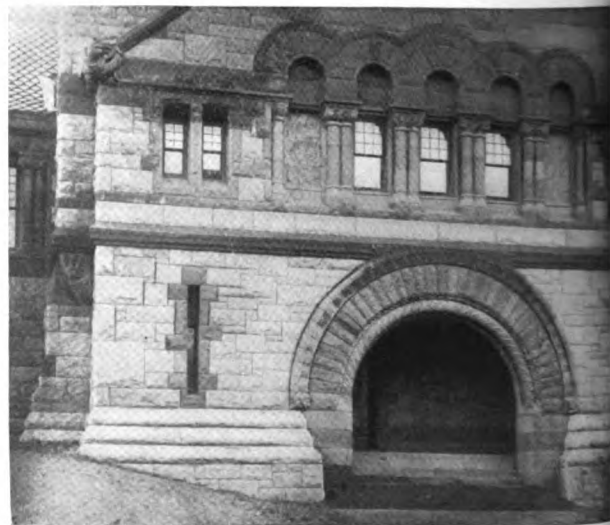

Entrance, Ames Memorial Library, North Easton, Mass. H. F. Richardson, Archt.

d it, but used it as ornament pure and simple, we seldom find it misplaced. Had he lived earlier, we might have seen a style developed based on Byzantine art, which would have gone far to establish a national school of ornament. Richardson appreciated the true value of color in his materials and handled them like a master. Note the combinations of brownstone, sandstone and granite, much of his work.

Among later men Mr. Louis H. Sullivan confidently holds a recognized position among modern designers, in that he has developed a rich vein of striking originality, delicacy and grace, which is more generally accepted and followed would justify classification as a distinct school. Mr. Sullivan, it is said, took as a suggestion from stem and leaf design the prairie lotus, tendrils and foliage being susceptible of freer treatment than the acanthus and with this plant he has combined lace-like geometric ornament introducing for greater interest at times, human and other animal forms, and flat modeled plain surfaces.

Originality in ornamental design is shown in the work of Mr. Wilson Eyre, Jr., Mr. Claude Landon, the late A. Page Brown, in the Mission style later referred to, Mr. H. T. Schladerer and others.

It is indeed to the younger men and those less harassed by the demands of an extensive practice that we must look for the greatest boldness and originality of the permissible sort.



Carving, State Capitol, Albany, N. Y.



Carving, State Capitol, Albany, N. Y.  
H. H. Richardson, Architect.





An English Bedroom.



Hall in Residence, Washington, D. C.  
H. H. Richardson, Architect.

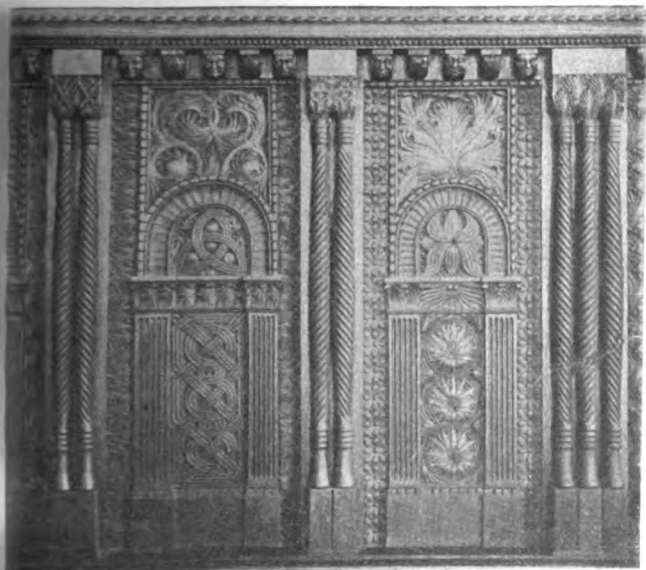

Carved Desk Front, State Capitol, Albany, N. Y.  
H. H. Richardson, Architect.

extensive practice often engulfs the individual, hence from numerous works of a large office it is difficult to select any piece which differs essentially in character from others. We note this tendency to similarity of scholastic and other





Station of Orleans Railway, Paris.

character in all the products of architects, painters and sculptors where they are in touch or close proximity even; it has always been so and always will be, but therefore when good original design is obvious, it is all the more to be observed and praised, for by such work we are greatly helped to avoid the speedy descent into commercialism which even now threatens the greater part of current work in this country. Architecture is easily made into millinery, if a man follows instead of forcing the taste

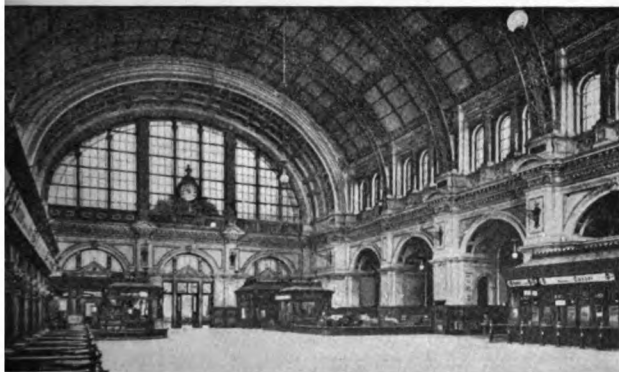

Railway Station, Frankfort-on-the-Main, Germany.

the day, and the only way to force the taste is to know what good, pursue it interestedly and with the assistance of training and talent do nothing half-heartedly. He is fortunate indeed who possesses these essential characteristics, but many of our modern designers do, and more are coming to the front. This is a golden age for the United States in more ways than one, and our national trait of haste does not kill the best talent that is beginning now to leave its impression on our houses, public



Suburban Station, H. H. Richardson, Architect.



Ornament.—Sullivan.

buildings and churches, we shall see the fruits of an American Renaissance of considerable interest in the history of art.

Schools of ornament are created by various causes: the fashion at court as during the times of Francis I, Louis XV and Napoleon I; the inspiration which comes to a nation by the importation of foreign wares; the art of a conquering race mingling with that of the conquered one, as in the case of the Moors in Spain, and the inspiration which comes to a single designer through study of the past and of even the contemporary art of another nation, of which we have examples in the careers of the brothers Adam, of Chippendale, and others; and still earlier in the work of Niccola Pisano and the beginnings of the Renaissance.

The most famous and enduring schools have all possessed that elusive quality which is due to great imagination. This is what appeals to one and all, and yet nothing is harder to define or more quickly secures a following. Time alone, however, decides whether a school or style is based on correct principles and worth perpetuating.

Much original and much interesting work is being done in the United States to-day and a good share of this is being done in the West.

In California the old Mission style has been revived by the late Mr. A. Page Brown with a promise of its becoming a state style at least, and no one can deny that it has great vitality. Its ornament is easily wrought in



Ornament.—Sullivan.

cco or plaster, and certainly the shadows in a light material  
e greater value to a design than those in a darker medium.  
f course the snow and rain of a colder climate would probably  
rease the pitch of the old Spanish roof slopes, but even now  
: find successful flat-roofed houses in the Northern states, and  
r great expositions are doing more and more to make us appre-  
te the beauty of Renaissance design as interpreted by the  
liest Spanish colonists of the Southwest and West. No one  
n confidently predict the coming national style in the United  
ates, and the chances are that there never will be one. Such  
ast country whose climate varies so widely, and whose great  
pulation has such varying needs and tastes can hardly be  
isified with one style, amalgamated as our people may become  
other ways.

Why is a national style desirable? It is a thing not to be  
orked for in itself. If it comes as the result of a logical  
e of materials to meet the needs of a rapidly growing popula-  
m in a progressive nation, it will naturally be an interesting  
ase in art, but not otherwise. To reach this end by conscious  
fort directed toward such a result would not be other than  
surd.



1



2



3



4



5



6



7



8



9

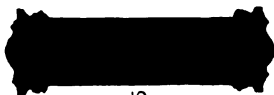

10



11



12

School—Modern.

## ale &amp; Towne Designs.

## Modern.

The Multipliers indicate the relative prices of the various Designs and Finishes, as compared with prices of corresponding pieces in the Cluny Design, paper Finish (CX22), pages 734 and 735. For Explanation of Multipliers page 34. For Explanation of Finish Symbols see page 609.

## AMBRIA—Figs 1 and 7, page 580, . 12 pieces, including

Esc'n Plates and Knobs, p. 580	Lever Handles, . . . . p. 879
Store Door Handles, . . " 747	Push Buttons, . . . . " 895
Appropriate Finishes: Copper (CY22) Mult'r 2.4; Silver (SX52) Mult'r 3.3; Iron (FX80) Mult'r 1.9	

## ASTILIAN—Fig. 2, page 580, . 18 pieces, including

Esc'n Plates and Knobs, p. 580	Push Buttons, . . . . p. 895
Cup Escutcheons, . . " 904	Push Plates, . . . . " 923*
Flush Sash Lifts, . . . " 916*	Key Plates, . . . . " 953
Door Pulls, . . . . " 824	
Appropriate Finish: Old Copper Plated (SCX17) Mult'r .25	

## BORIAN—Figs. 3 and 8, page 580, . 54 pieces, including

Esc'n Plates and Knobs, p. 580	Cupboard Catches, . . . p. †
Store Door Handles, . . " 759	Transom Catches, . . . " †
Cup Escutcheons, . . . " 905	Chain Door Fasts, . . . " †
Flush Sash Lifts, . . . . " 916*	Chain Bolts, . . . . . " †
Hook Sash Lifts, . . . . " †	Barrel Bolts, . . . . . " †
Bar Sash Lifts, . . . . . " †	Foot Bolts, . . . . . " †
Offset Bar Pulls, . . . . " †	Door Pulls, . . . . . " 825
Letter Drop Plates, . . . " 917*	Push Buttons, . . . . . " 896
Extension Bolts, . . . . " 894*	Push Plates, . . . . . " 923*
Mortise Door Bolts, . . . " †	Shutter Knobs, . . . . . " 940
Cupboard Turns, . . . . . " †	Butts, . . . . . " 919*
French Window Catches " †	Cabinet Trim, . . . . . " 968
Appropriate Finishes: Bronze (BZ16) Mult'r .25; Steel (SB24) and Iron (FB24) Mult'r .15	

## ARMA—Figs. 5, 6 and 9, page 580, . 34 pieces, including

Esc'n Plates and Knobs, p. 580	Door Pulls, . . . . . p. 827
Store Door Handles, . . " 755	Push Buttons, . . . . . " 897
Cup Escutcheons, . . . . " 906	Push Plates, . . . . . " 923*
Letter Drop Plates, . . . " 917, Fig. 5 & 6	
Appropriate Finishes: Copper (CX22) Mult'r 1.4; Silver (SX52) Mult'r 2.1; Iron (FX80) Mult'r 1.1	

## ENLIS—Figs. 4, 10, 11 and 12, page 580, . 22 pieces, including

Esc'n Plates and Knobs, p. 580	Door Pulls, . . . . . p. 828
Store Door Handles, . . . " 755	Push Buttons, . . . . . " 897
Letter Drop Plates, . . . . " 917, Fig. 1 & 2	Push Plates, . . . . . " 923*
Appropriate Finishes: Copper (CX22) Mult'r 3.; Silver (SX52) Mult'r 3.9; Iron (FX80) Mult'r 2.1	

A few Designs only are shown as examples. † Not illustrated.





## Section 4.

### Emblematic Hardware.



**I**N OCCASIONAL cases it is found desirable to indicate the character or use of a building by introducing one or more appropriate emblems in the design of the Hardware of Ornament.

This is especially true of buildings for Masonic or other lodges, for clubs, societies, etc., in which case the emblems of regalia, badges, etc., can be availed of; of municipal, state or government buildings, in which case the coat of arms or public seal may be introduced; and of buildings for railroad companies, banks, etc., in which cases the monogram, seal or name of the corporation is frequently reproduced.

In all such cases the device selected is usually introduced as the central ornament of the door knobs, see page 584, and also repeated on escutcheon and push plates, and generally on the larger pieces of metal work, see pages 582 and 585. It may constitute the sole feature of decoration, but usually has associated with it a border or other ornament.

The extensive line of standard designs of the Yale & Towne Manufacturing Company includes some of emblematic character, but generally the use of Emblematic Hardware involves the cost of special designs and patterns, as in the case of "Proprietary



1



2



3



4



5



6



7



8



9



10



11



12



13



14



15



16



17



18



19



20

Hardware," so that the remarks under the latter head (see Section 5, page 587) apply equally in this case.

The accompanying illustrations show a few out of a very large number of emblematic designs heretofore executed, and will serve to illustrate the possibilities of the subject.

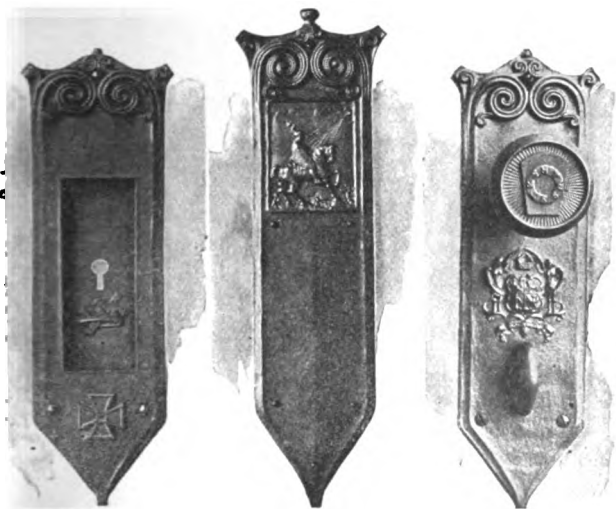

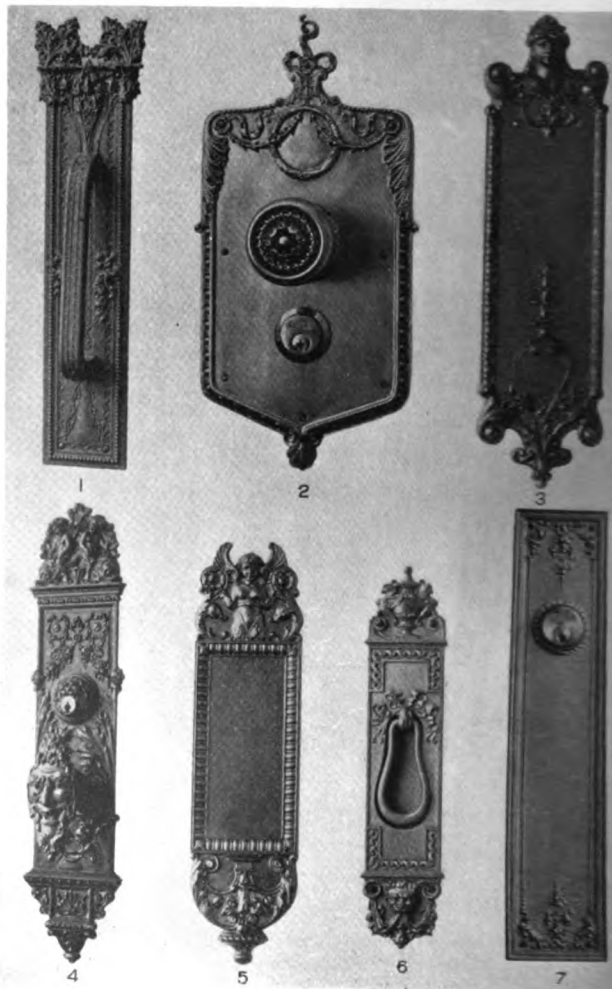

Proprietary Hardware

## Section 5.

### Proprietary Hardware.



THE impress of individuality marks all of the important work of the successful architect and may be extended properly to the subordinate details of decoration, especially where it is essential that these should harmonize with the general scheme.

Hence, in some cases the architect furnishes the designs, or at least the leading *motif*, for the hardware of ornament for the whole, or at least the important parts, of a building. This of course involves the added expense of special drawings, models and patterns, and thus entails a considerably greater cost than the use of standard designs, so that the plan is not usually resorted to except in cases where the question of cost is subordinated to that of perfection of result.

The necessity of such resort has been greatly diminished by the creation during recent years of extensive collections of standard designs, such pre-eminently as that of the Yale & Towne Manufacturing Company, which already embraces upward of 250 designs (each comprising a large number of pieces of every kind usually required and of many sizes) each in some distinct school of ornament, from which fitting selections can be made



Door Knob.

the Company referred to can effectively be utilized to secure the best result at the least cost with minimum trouble to the architect.

The Art Department of the Company includes a permanent staff of designers, modelers, chasers and pattern makers, together with the most modern appliances for facilitating the work at every stage, thus enabling it to submit new and original designs (in any designated school) or to render designs, or even *motifs*, furnished by the architect, and in either case to execute work so intrusted to it in the most intelligent and artistic manner, and in harmony with the intentions of the architect and his client. When so agreed, the patterns pertaining to such special work are treated as "Proprietary," and are either destroyed after use or held for the exclusive benefit of the architect or client for whom made.

The engravings on page 586 reproduce a few of the Proprietary designs heretofore executed, and are illustrative of the individuality and scope which the method admits of, but it will, of course, be understood that none of them are available for further use unless by the consent of the parties for whom made.

for almost every use without danger of repetition and without fear that the designs selected may become hackneyed by too general use. Therefore, it is advisable that a careful examination of catalogue designs be made before incurring the greater expense entailed by the adoption of special designs.

Where, however, it is decided to adopt the latter course the facilities

## Section 6.

---

### French Hardware.

**T**HIS term designates hardware of a type, special both in construction and ornament, the characteristic features of which spring from the fact that in France the fastenings for doors and windows are almost invariably of rim construction (that is, applied to the surface of the wood, not mortised into it) and, being thus exposed to view, are always treated with more or less reference to decorative effect. This preference for "rim" fastenings arises doubtless from the general use of hardwood for doors and sashes, the thickness of which latter is usually less than in American practice.

A further influence is the fact that sashes are almost invariably of the casement or hinged type, the sliding or *guillotine* sash being very seldom used. Hence windows and doors in France have much in common, both in their construction and in the hardware required, and the treatment of the latter for each purpose influences its treatment for the other. The most important hardware element is the vertical bolt, whether of the *spagnolette* or the *cremorne* type,\* used both with doors and with casement sashes to secure them at top, bottom and centre, the functions of which necessitate good mechanical construction, while its prominence justifies and promotes artistic treatment in ornamental designs.

The conditions referred to imply also that the door lock is of rim construction, exposed to view, and hence it has long been

\* Illustrated and described in Part VII.

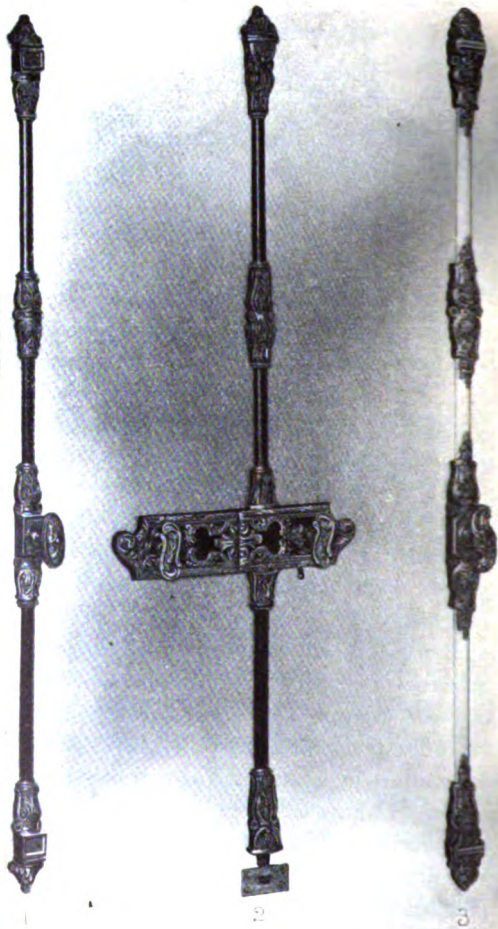

**Cremorne and Espagnolette Bolts.**



Rim Door Lock.

customary in France to ornament the cases of door locks of the finer grades, as well as the knobs and escutcheons which are used with them.

Finally, French carpentry favors the employment of horizontal rather than upright or vertical locks, and this imparts a further characteristic both to the lock itself and to the ornamental escutcheon plates used to trim the opposite face of the door, the lock case and its escutcheon plate usually being repeated in the case of double doors.

In France nearly all important doors are double, the standing part usually being fastened by a cremorne bolt, operated by mechanism contained in a box or case coinciding with the lock



Rim Door Lock.



Rim Door Lock.

on the other part of the door and frequently duplicating the latter in size and decoration. The whole *garniture* thus becomes a prominent feature of the door, and one which admits indefinitely of elaboration in decorative treatment. The opportunity thus afforded is freely availed of in French practice, these fastenings often being of expensive character and exhibiting artistic skill and taste in the highest degree. Several of their various forms are indicated by the illustrations on page 590.



Knob.

Both knobs and lever handles are used, the knob when employed being usually of oval rather than of round form, but the customary use of very stiff springs on latch bolts tends to create a preference for the lever handle, especially on important doors. Possibly this preference may reflect an impulse imported originally from Germany where, the use of narrow door stiles being common, upright locks with small backset are used, and lever handles are a necessity as the space between the knob, if used, and the door jamb would be too small for the hand. Where a lever handle is used a stiff spring is required to support its unbalanced weight, and as French and German lock makers do this by means of the spring on the latch bolt, it follows that the latter is so stiff that it will rarely retract automatically when the bolt impinges



Rim Door Lock.

its strike, and hence every one is accustomed to turn the handle or knob to permit a door to close as well as to permit it to open. In France it is quite customary to use a lever handle on the outside and a knob on the inner or lock side of the door. The American lock maker on the contrary has long employed the "easy spring" construction for latch bolts, and so, in designing locks for use with lever handles, has been obliged to support the latter by a separate spring of proper stiffness, and thus has allowed the latch bolt to retain its "easy spring" which permits it to retract easily and automatically when the door is closed, thus giving a much better action than the French or German locks.



Knob.

In the matter of *decoration* French locks and their trim, and also the espagnolette and remorne bolts used with casement sashes, exemplify strongly the characteristics of French decorative art, and many of them are beautiful examples of tasteful and correct designing, but the *mechanical* execution of the work is often of coarse and inferior character which compares unfavorably with the best examples of modern American production. Examples of French work of this kind are shown by the accompanying illustrations.

The marked preference in America for mortise rather than rim locks has led to a compromise which consists in the use of a



Knob.

horizontal mortise lock, trimmed on both sides with a horizontal escutcheon plate, thus reproducing on *both* sides of the door the effect which is seen on the *outside* of a French door. Where this is done, however, it usually becomes necessary, in the case of double doors, to secure the standing part by rim bolts of the French type at top and bottom, instead of by the cremorne bolt which is more commonly used in France. Where the French effect is sought it will best be obtained by the use of rim locks and bolts.

The illustrations in this article are from actual examples of French Hardware, of various periods and schools, and are available either in the forms shown, or modified to meet the requirements of architect or client. Where hardware of the French type is used early coöperation is expedient between the architect, the contractor and the lock maker, in order to harmonize the work of each with that of the others, to avoid the serious difficulties which are otherwise almost certain to be encountered and to secure the best results.



1



2



3



4



5



6



7



8



9



10



11



12

**Some Recent Designs**



13



14



15



16



17



18



20



21



24



19



22



23



25



26



27



28



29

### Some Recent Designs

Referred to in Lists of Designs Arranged by Schools, pages 235 to 581

## Section 7.

### Metals and Finishes.

#### METALS.

**T**HE metals practically available for the production of Hardware are Iron in its various forms, including Steel, and the alloys of Copper, known as Bronze and Brass. Gold, Silver, Nickel and Copper are also used as platings.

**CAST IRON.**—This is the chief material of construction, and, by reason of the high quality of American irons and the skill of American foundrymen, a vast number of articles are made of it here which in European countries are still made, chiefly by hand, of wrought iron.

This, however, implies no inferiority of the American product; on the contrary, the latter is always neater in appearance and usually better adapted to its purpose, than its foreign equivalent. Properly used, cast iron is not only usually the cheapest but often the best material of construction, and will continue to hold a leading place as such, even though displaced by steel for some uses. It is also admirably adapted to decorative work, and, by the development of the Bower-Barff process, described elsewhere, has been restored to its proper position in this respect. No other metal excels it in sharpness of definition in the reproduction of fine modeling, as is demonstrated by the beautiful and delicate art work in cast iron which for more than a century has been produced in Southern Russia and in Bohemia.

**WROUGHT IRON.**—This is the original material for all hardware, and is still the material chiefly used in all countries but America, where it has largely been displaced, as explained above.



Here it is still used to a limited extent, but chiefly for decorative purposes, especially where only one or a few pieces of special design are required. For grille work it is, *par excellence*, the proper material.

**MALLEABLE IRON.**—This is a form of cast iron which, by supplementary treatment in a special furnace, is converted into a semi-steel, and thus has imparted to it a certain degree of toughness and strength. It is a rather rough product, however, and is little used except for cheap keys, and for parts requiring extra strength. It is not available for fine decorative work.

**WROUGHT STEEL.**—This is practically a new material, for which we are indebted to the converter process of Bessemer, the open-hearth process of Siemens, and the wonderful development of the steel industry which has followed therefrom.

The initiative in its application to Builders' Hardware, (butts excepted) was taken by the Yale & Towne Mfg. Co. in 1890, when it brought out a steel Mortise Lock, No. 1620S. Some years later other lock-makers, (notably Warner), followed suit with additional styles of steel locks, and in 1895, the "Vulcan" Locks (see page 127), (a complete line of Builders' Locks, made wholly of steel, or other wrought metals) was brought out. Since when all of the leading manufacturers have applied this material extensively not only to lock making but to the production of lock trim and small hardware generally. The relative merits of cast and wrought hardware are discussed below.

**COPPER.**—This metal, when unalloyed, is not available for constructive use because too soft, nor for ornamental work because it does not cast well. Therefore, when its color is desired it is obtained by electro plating copper on articles made of some stronger material.

**CAST BRONZE AND BRASS.**—Whether wrought or cast, Bronze and Brass are both *alloys*. Bronze contains about 90 per cent.

of copper, alloyed with tin and spelter (or zinc); while Brass contains about 65 per cent. of copper alloyed with spelter and lead. The former has a reddish color, while the latter is distinctly yellow. Bronze costs more, is harder and is better where strength is required; but brass is only slightly inferior and can properly be used where its peculiar color is preferred. Both cast well, are susceptible of high polish, and adapt themselves admirably to a great variety of finishes as described elsewhere. Although moisture discolors them it produces no destructive corrosion, as in the case of iron and steel, and hence these alloys are especially available for work which is exposed to the weather, or to the effect of sea air or water. They are pre-eminently the best materials for decorative work.

**WROUGHT BRONZE AND BRASS.**—To produce these materials the alloys above described are cast into ingots, and the latter are then rolled into sheets or drawn into wire. As sheet metal can be rolled much thinner, and wire drawn much smaller, than any casting, considerable reduction of weight thus becomes possible, which is offset by the greater strength of the wrought material, provided the reduction in size is not carried too far. For many uses the wrought material is the better of the two, but unfortunately it has been so attenuated in the commercial product, in the effort after cheapness, that much wrought hardware is unfit for use, and great care is needed in selecting it. This question is further discussed below.

**WIRE GOODS**—Certain articles, such as coat and hat hooks, of many kinds, screw eyes, etc., are now made from wire. The better grades of these are excellent, although usually less handsome and substantial in appearance than the corresponding article of cast metal, but here also the effort after cheapness has had an injurious effect, and care in selection is needed.

**CAST *versus* WROUGHT HARDWARE.**—No rule can be laid down

to govern the choice between these. Each is better than the other for certain uses, and each is prostituted to the effort after cheapness in the lower grades of goods. Most wrought steel locks, including the "Vulcan Jr.," (see page 127), are intended to meet the demand for a cheap commercial article, although the "Vulcan" line is distinctly of high grade, and intended for use in buildings of the first class. All builders' locks of the larger sizes and highest grades are of cast metal.

In General Hardware the line is less defined. The wrought metal butt made by the Stanley Works, for example, in its better grades, is a thoroughly first-class product, suitable for a wide range of uses, and yet it is not so handsome and satisfying on fine work as the heavier and more appropriate full-weight cast bronze butt. So also as to bolts, sash fasts and other minor fastenings.

Surface Trim of *Wrought* Metal, such as escutcheon plates, sash lifts, etc., shaped up in dies, was first introduced by the Yale & Towne Mfg. Co., in plain metal, about 1891, and in ornamented metal in 1894, in both cases the material being of ample thickness, and the product equal to, if not better than, the best cast work. Both leads were soon followed by other manufacturers, even to the extent of closely copying the first ornamental wrought metal design "Arcadian," (see page 236) but unfortunately without adherence to the original high standard of quality, since when this product has deteriorated to a commercial and very competitive basis, some of it still being of fair quality, but much of it so thin and flimsy as to merit its nickname of "tinware," and to be unfit for architects' use. Inspection of actual samples is now the only safe basis for the selection of wrought metal trim, whether plain or ornamental.

Surface Trim of *Cast* Metal, of the commercial and medium

grades, is now made in great variety by all leading manufacturers, and offers a far wider range of choice than that made of *wrought metal*, because of the heavy investment in dies which the latter involves, so that the cast product is usually preferred, except for plain goods. For the latter wrought metal, *if of good weight*, is to be preferred, but great care is needed to guard against the substitution of "tinware."

All of the finer grades of ornamental hardware are invariably made of cast metal, for reasons and under conditions which are fully discussed elsewhere.\*

In conclusion it may be said that if care be taken to secure only the better grades of wrought hardware, it is appropriate for many uses, especially in places where utility, rather than ornament, is the purpose, but that elsewhere preference should be given to the cast product, and that the latter is the only one to be considered for use in important work.

### PLATINGS.

In some of the fine houses of an earlier day, still to be found in our older cities, may occasionally be seen silver-plated hinges and knobs, corresponding in solidity of appearance with the mahogany doors with which they were usually associated. These mark the acme of elegance in the hardware of that day, and were not only handsome but very expensive, as the plating consisted of a sheet of rolled silver, of substantial thickness, which was soldered or "sweated" onto the brass behind it, and then finely polished. This was known as "hand-plating" or "close-plating," a process now almost forgotten.

\*See article on Artistic Hardware by Montgomery Schuyler, page 45.

“*Nous avons changé tout cela.*” Electro-metallurgy has given us the means of producing an equal or better result at far less cost, and also enables us to plate with any metal, and upon irregular as easily as on plane surfaces. Like other modern and improved processes, however, it makes possible the doing of poor work at little cost, as well as of good work at moderate cost, and hence the term “electro-plate” has acquired a disrepute which it does not merit. All plating in all the industrial arts is now done by this process, and the quality is whatever the manufacturer chooses to make it. Much of it is poor, but more of it is fairly good, and some of it is of the highest quality. Practically the buyer has no means of gauging the thickness or quality of plate; his only guaranty is the honesty and good repute of the maker, and his best protection consists in buying goods made by houses whose reputation is established and whose good faith is above question. Especially is this true as to goods plated with Gold or Silver. In these low price and high quality cannot coexist, and the buyer will usually receive about what he pays for, whatever the price may be.

**COPPER PLATING.**—This is very largely used, and admits of a great variety of effects. Pure or “Virgin” copper is fine in color, but so sensitive that it is seldom used. The other effects are described under the head of “Finishes.” All of them are *tarnishes*; that is, they are produced by chemical action on the surface of the copper, and, therefore, will disappear under severe rubbing or hard usage. Copper can be deposited on any of the other metals. Copper finishes have been very popular, because of the novelty and variety of effects obtainable, but, as they are chiefly surface discolorations of the copper, they have less merit than other platings which are used in their natural colors and which, therefore, are more durable.

**COPPER DIPPED** is a term used to designate a very light cost-

ng of copper, put on iron and steel goods to retard their rusting, obtained by merely dipping the article for a few minutes in copper solution.

**BRONZE PLATING.**—This is largely used on iron and steel goods to make them appear like real bronze, and is so effective that, if well done, it is difficult even for the expert to distinguish the imitation from the real article. Where bronze plating is heavy and well done, and is applied to iron and steel hardware of good quality, the product becomes thoroughly legitimate and is suitable for use in many places, such as attics, kitchens and the upper floors of small houses, but care is needed to secure this grade of plated goods, and to prevent the substitution of very light weight hardware, with still lighter weight bronze plating, the difference being difficult to detect after the goods are applied, although it soon becomes apparent under use.

**BRASS PLATING.**—The foregoing remarks apply as well to brass as to Bronze plating. There is a marked tendency toward larger use of Brass, both in solid and plated goods, especially in Colonial work, and there is every reason to welcome this as an agreeable change from the almost universal use of bronze which has prevailed for many years.

**NICKEL PLATING.**—During the "Seventies" and the "East-ake" period, nickel, then recently made available commercially, was thought attractive, and the term "nickel-plate" was a symbol of superlative quality, even being chosen as the advertising nickname of a great railroad. To-day, however, nickel plate is very little used, except on plumbers' fittings and on hardware used in bath-rooms, toilets, etc. Even when new its color is less pleasing than that of silver, and after a time it is apt to become dull by reason of an oxidation or tarnish which, although slight, is very difficult to remove. All steel keys of the better grades are nickel plated to prevent rusting.

**SILVER PLATING.**—The great decline in price has made Silver available for a greatly increased range of uses, thus making the "Silver question" a commercial as well as a political issue, and Silver plated hardware is now extensively used, especially in residence work. Silver is a sensitive metal, however, which tarnishes easily and needs frequent cleaning to keep it bright. Therefore, it is not recommended for use in cities where the atmosphere contains an excess of sulphur from coal gasses, nor is it an appropriate finish for highly ornamented surfaces, owing to the difficulty in cleaning which these present. It is admirably adapted, however, for all kinds of plain hardware, and even for certain ornamental designs which admit of being properly cleaned when necessary.

**GOLD PLATING.**—This also has recently come into large and increasing use, because of the superb effects obtained by it, because of its absolute permanence, and because the increased cost entailed is so moderate in proportion to the great gain in quality. Fine metal work, whether decorated or plain, acquires such enhanced effect from gold plating as to impart a distinction to it which is unique and unapproachable. An inspection of such work will verify this assertion, and will suggest the expediency of at least considering the use of gold-plated hardware in the important rooms of handsome residences and other buildings. It is most frequently used in parlors, libraries, ball-rooms, etc., but in some cases its use is extended even to the bed-rooms, not only for effect but still more because of its permanence and the resulting relief from all need of care and cleaning.

**THICKNESS OF PLATE.**—Obviously the thickness, or weight, of plating directly determines its endurance under wear, and as nearly all hardware is exposed to more or less wear this question becomes material. Some pieces of hardware, such as knobs, are subjected to severe wear, others to moderate wear, and still

others practically to none at all, and this difference should be recognized by using a much heavier plate on articles which are liable to be much handled. In the case of copper, bronze and brass plating the labor cost of plating is much more than that of the metal, and the temptation to "skin" the latter is proportionately small, but in the case of gold and silver plating the cost is almost in direct ratio to its *thickness* or *weight*, and, as stated above, the only guaranty as to this consists in the repute and good faith of the manufacturer, and price is, or should be, an index to the quality of the work.

Recognizing the differences above referred to The Yale & Towne Mfg. Co. has adopted a graded system of weights or thicknesses of plating, as follows, viz :

*Single Plate* : Used only on articles which are but little handled in use, such as escutcheon plates, lock fronts, etc.

*Double Plate* : Used on articles subject to moderate wear, such as bolts, sash fasts, drawer pulls, etc.

*Triple Plate* : Used on knobs, handles, keys and all other articles liable to much handling and wear.

Under this system the amount of gold, silver or other metal deposited in each case is carefully determined, by galvanometric appliances, and is maintained at the established standards, which latter are believed to be higher than those resulting from the haphazard methods commonly employed.

**TINNING.**—This process is little used in connection with hardware, except in the case of malleable iron keys for cheap locks. It is not a plating process, but is effected by dipping the work to be "tinned" in a bath of molten alloy, of which tin is the principal ingredient.



## FINISHES.

The metals used in making hardware and for plating it, have been discussed in the two preceding articles, but other factors are also involved in the determination of "Finish," which term implies the final appearance or finish given to the metals.

**TEXTURE OF SURFACE.**—This has a marked influence on the character and effect of every Finish. The finish of Plain Hardware is nearly always a polish obtained by the use of emery wheels revolving at high velocity, but the resulting surface may be of various "textures," according to the fineness of the polishing wheel. The highest polish is obtained by the use of buffing wheels, made of felt or cloth, saturated with rouge, and the very bright surface so produced is termed "buffed."

Ornamental Hardware, with incised or flat ornament, may have its raised surfaces polished, but if the surface of the ornament is irregular or modeled, the polishing wheel cannot be used. The most artistic results are usually obtained from modeled surfaces, untouched by the wheel. A new and very attractive "texture" has been added by the "sand-blast" process, described below, while still others are obtained by foundry manipulation. The most appropriate texture for each design depends on the character of the latter, and on the "color" selected for it. Personal taste enters largely into these questions, and personal selection, by sample, should always be availed of, if possible, unless previous experience renders this unnecessary.

**COLORS OF SURFACES.**—This term denotes the color of the final finish, whether this be the natural color of the metal, or a modified color given to it by chemical manipulation, as explained below. The variety of "colors" in use is very large, and the choice of "color," like that of "texture," depends upon the character of the article, and still more on personal taste. Here again personal selection, by sample, is always desirable.

In the case of iron and steel, color is obtained by the use of colored japans and lacquers, or else by plating with copper, bronze or brass, and coloring the latter as desired, but by far the best effect on these metals is obtained by means of the Bower-Barff process, described below. Bronze and brass are largely used in their natural colors, but also in a variety of other tints, usually darker, known by various names such as "Statuary Bronze," "Old Brass," etc., or, when copper-plated, as "Oxidized Copper." All of these fancy finishes, on bronze and brass, without exception, are *surface discolorations*, or *tarnishes*, produced by the use of acids and other chemical reagents. Many of them are very attractive, but none of them have the durability of the natural metal, and this fact should always be kept in view when deciding on the "Finish" to be used in any given case. Where exposed to constant handling, as in the case of knobs in an office building, these finishes soon wear off in spots, thus exposing the natural metal below. Where not excessively handled, however, they stand well, and by protecting the metal from further change from exposure, they diminish or obviate the need of frequent cleaning. It is to be noted also that the use of the natural metals (gold only excepted,) is not free from difficulties, as all of them tarnish quickly from exposure and handling. To prevent this the manufacturer covers them with a thin film of lacquer (usually a solution of gun-cotton,) which, being invisible, retains the color of the metal and yet protects it from the atmosphere. If not much handled or exposed this protection is effective for a long time, but under handling it soon wears off. If discoloration then occurs the only remedy is occasional polishing by hand, (with a chamois skin and any good polishing powder, such as "Putz-pomade" or "Bon Ami"), in which case it is better to remove *all* of the lacquer by first washing the article with alcohol or sulphuric ether. Where it is

intended to rely on *rubbing* to keep bronze and brass work bright, it is well to order it "unlacquered" originally.

All of the foregoing remarks apply also to silver-plated goods, whether plain or "oxidized," silver being a very sensitive metal. Gold is the one available metal which is self-preservative and not affected by exposure or use, and attention is again called to the arguments in favor of its availability which are stated above.

The character of each of the numerous "colors" obtainable by the processes now in use cannot effectively be understood from any written description; the only safe method of selection is by sample.

**THE BOWER-BARFF PROCESS.**—This process is the invention of two Englishmen, whose names it bears. It was applied originally to the protection of water pipes, architectural iron work and other rough products. In 1887 the author, believing that it might be utilized for work of finer character, obtained for The Yale & Towne Mfg. Co. an exclusive license for its application in the United States, to Builders' Hardware, and the company, after building the necessary furnace, proceeded to experiment in this new field. Many unexpected difficulties were encountered, and much time and expense involved in overcoming them, but finally complete success was attained. The new finish was so entirely different from anything before known, and gave such character and dignity to the work on which used, as at once to attract the enthusiastic interest of Architects and to lead to the restoration of iron to its former and rightful place as one of the noble metals in its relation to decorative art.

The Bower-Barff process consists in treating the iron or steel in a special furnace, by gasses, at a high temperature, whereby the surface of the metal is converted, first, into the sesqui-oxide ( $\text{Fe}_2\text{O}_3$ ), and, subsequently, into the magnetic or black oxide

iron ( $\text{Fe}_3\text{O}_4$ ), the chemical result thus obtained being permanent and unchangeable. Its color is a lustrous black, of great depth and softness, and is particularly effective on fine ornament.

As a protection against corrosion from the sulphurated gaseous city atmosphere it excels all other finishes except gold, but it is not well adapted for outdoor use, where directly exposed to the weather or to salt air, for the reason that the "skin" developed by the process, although of considerable thickness and exceedingly hard, is liable to have minute pores through which, though almost invisible, moisture may obtain access to the unprotected metal under the "skin," which then rusts, thus producing discoloration and a tendency of these spots to become larger by flaking off the skin around them. Where used under proper conditions, however, this finish is not only one of the handsomest, but also the most enduring ever discovered.

Since the expiration of the Bower-Barff patents other manufacturers have adopted this process, but not always with the knowledge or facilities necessary for entire success, so that uncertain, and sometimes unsatisfactory, work has resulted. This is not chargeable to the process, however, which, if perfectly performed, yields a uniform and perfect product. It is conceded that in the field of small and decorative work the process has attained a higher degree of perfection as conducted in the Yale & Towne works than anywhere else in the world.

**THE SAND BLAST.**—Many years ago the late Richard A. Tilghman, of Philadelphia, a chemist and scientist of high repute, noticed that the window glass in his seashore cottage became dulled, and occasionally had to be replaced. Reasoning as to the cause of this, he concluded that it was the result of the impact against the glass of particles of sand impelled by high winds. A simple experiment in his laboratory confirmed this surmise, and hence the discovery of the "Sand-blast," which

has since been applied to a great diversity of uses, including the cutting of glass, stone and metals.

While making the early experiments with the Bower-Barff process, in which trouble was experienced from the unequal effects obtained on surfaces which required to be previously machined and on those which were not, the author recalled the invention of Mr. Tilghman, whom he had known for many years, and consulted him as to the availability of using the sand-blast as a means of producing a uniform texture on metallic surfaces. Experiments, in 1888, quickly demonstrated that the sand-blast would not only accomplish what was sought, uniformity of surface, but also that the result was a new and very beautiful texture, peculiarly effective with the Bower-Barff process, and also available for other metals and finishes. So long as Mr. Tilghman controlled the sand-blast by patents The Yaic & Towne Mfg. Co. had the exclusive use of it for Builders' Hardware, and developed a number of improvements in its application to such work. Since the patents have expired, however, this process also has been adopted by other manufacturers, although usually in cruder and somewhat less effective form than that devised by the original users.

Its effect on metal is to obliterate all irregularities of finish, and to produce a velvety texture, of great softness and delicacy, which forms a beautiful ground or surface for almost every kind of finish.

**GREEN BRONZES.**—The beautiful coloring of the old vases and statuary found in ancient cities, is due to a *patina*, or oxidation, produced by the long continued action of the elements, and the same effect develops slowly on modern statuary when exposed to the weather. The result thus attained by nature is simulated, more or less closely, by several of the dark bronze finishes in common use by all manufacturers of hardware, but these are all

duced as above explained, and are open to the objections here stated. An exception to this statement can be made, however, in the case of The Yale & Towne finishes designated as "Verde Antique" (67), "Pompeian" (69) and "Olive bronze" (68), included in the table at end of this section. These have a veritable *patina*, of considerable thickness and decided hardness, which is produced in a peculiar furnace by chemical action. These unique finishes are *harder and more durable* than any of those ordinarily used on bronze or brass, and cover a wide variety of "colors" and effects, depending greatly on the character and texture of the surface on which produced. They are especially appropriate in halls and public buildings.

#### NOMENCLATURE OF FINISHES.

From the preceding discussion of metals and their finishes it will be seen that the latter have outgrown the primitive method of designation by fancy names or arbitrary numbers, and that an intelligent and comprehensive system of nomenclature has become desirable, if indeed not really necessary.

As such a system exists, and is used in connection with the extensive line of ornamental designs described in Part III, under the title "Schools of Ornament," it is thought that an explanation of the plan on which that system is based will assist in a clearer understanding of the subject of "Finishes," and facilitate the preparation of specifications and schedules.

In undertaking to devise this system for The Yale & Towne Mfg. Co. the author followed somewhat the lines of chemical nomenclature, and provided for its indefinite future expansion by adopting separate symbols for each of the variable elements, these units being combined to form the complete symbol for any given

finish. The *variables* entering into the several finishes are as follows, viz.:

1. The *metal* (whether solid or a plating).
2. The *texture* of its surface.
3. The *color* finally imparted to it.

Hence the symbol for each finish is composed of three variables, viz.:

1. A *first letter*, indicating the metal.
2. A *second letter*, indicating the texture ; and
3. A *number*, indicating the color.

Thus "BZ10" is the symbol for "cast bronze, buffed, in natural color ;" "B" being the symbol for cast bronze, "Z" the symbol for a buffed surface, and "10" the symbol for a metal in the natural color.

The symbols used in this system, (the only one in use which is not chiefly or entirely arbitrary), are as follows :

METALS (*first letter*).

Brass	A	cast or wrought.
Bronze	B	" "
Copper	C	" wrought not used.
Nickel	N	" " "
Silver	S	" " "
Gold	G	" " "
Iron	F	" " "

Steel, cast not used, S wrought.

NOTE.—Although S is used to indicate both silver and steel, it is found that no confusion occurs in practice, owing to the widely different conditions under which each metal is used.

TEXTURE OF SURFACE (*second letter*).

V.—Unpolished ; as left by the mold or die.

W.—Wheel finished ; surface polished, but not buffed.

X.—Sanded finish ; with fine grain, as from statuary moulding.

Y.—Dead-smooth finish ; but without bright polish.

Z.—Buffed ; high polish, bright.

NOTE.—When hand-chasing of the ornament is super-added to any of the above, the fact is indicated by using the term "Hand-Chased."

*Plated finishes* are ordinarily designated by a symbol containing only two letters, the first of which indicates the metal of the *plating*, without regard to the metal of which the article is made, and the second the *texture*, followed by a number indicating the *color*.

If it is desired that the symbol shall indicate both facts, *three letters* may be used, the *first* indicating the material of construction, the *second* the metal used for plating, and the *third* the texture of surface.

#### COLOR OF SURFACE (*terminal number*).

- |   |  |
|---|--|
| 1. White enamel.  | 50. Imitation Gold, light.                     |
| 3. Japanned matte, imitation of 36.                                   | 52. Light oxidized, no relief.                 |
| 4. Ebonized " " "   | 53. Natural color, deadened.                   |
| 5. Lacquered with transparent colorless lacquer.                      | 54. Dark oxidized.                             |
| 6. Japanese Bronzed, on Steel or Iron, colored japan (Boston finish). | 55. Black oxidized.                            |
| 8. Manilla or yellow lacquer.   | 56. Half polished iron.                        |
| 10. Natural color of metal.   | 57. Dark, center relieved.                     |
| 12. Colored, light tint, relieved.                                    | 61. Light, Verde Antipue.                      |
| 13. " " " no relief.  | 62. Gun metal, brown.                          |
| 14. " dark " "  | 63. Butler's Silver.                           |
| 15. Ormolu metal.   | 64. Mottled.                                   |
| 16. Oxidized black.   | 65. Statuary Bronze, no relief.                |
| 17. Old metal, medium dark, relieved transversely.                    | 65 <sup>1</sup> / <sub>2</sub> . " " relieved. |
| 18. Old metal, medium dark, relieved irregularly.                     | 66. " Verde Antique.                           |
| 19. Ormolu dip.   | 67. Dark Verde Antique.                        |
| 20. Old metal, dark, ends relieved.                                   | 68. Olive Bronze, relieved.                    |
| 22. Old metal, light.   | 69. Pompeian Bronze.                           |
| 24. " " dark.   | 70. Sage Green.                                |
| 25. Royal Copper.   | 80. Bower-Barff finish.                        |
|   | <i>For Relieved Surfaces Only.</i>             |
|   | 34. Matte, chocolate color.                    |
|   | 36. " ebonized.                                |
|   | 37. " steel gray.                              |

NOTE.—In addition to the regular finishes many others can be obtained, especially in Copper, Silver and Green Bronzes, each having a different shade, color or tone, and of late architects have frequently resorted to these special finishes in order to obtain novel effects. It is proper to point out, however, that *irregular* finishes almost always entail increased cost and delay, and sometimes involve also a tendency to subsequent discoloration which does not appear at first, but which, in time, may become serious. For these reasons it is recommended that the regular finishes be availed of if possible.



## Standard Finishes.

Under the following groups will be found the finishes most appropriate for each of the several metals and the symbols designating such finishes according to the system described on preceding pages.

## BRASS—A.

Natural Color, wheel finish . . .	<b>AW10</b>	Light verde antique, sand finish	<b>AX61</b>
“ “ buffed . . . . .	<b>AZ10</b>	Natural color, dead finish . . . .	<b>AY10</b>
Ormolu brass, high parts buffed	<b>AZ15</b>	Old metal, light, dead finish . . .	<b>AY22</b>
Medium dark, transverse relief .	<b>AZ17</b>	“ “ dark, “ “ . . . . .	<b>AY24</b>
Natural color, sand finish . . . .	<b>AX10</b>	Ormolu, imitating gold, dead	
Medium dark, transverse relief,		finish . . . . .	<b>AY52</b>
sand finish, . . . . .	<b>AX 7</b>		

## BRONZE—B.

Natural color, wheel finish . . .	<b>BW10</b>	Light verde antique, sand finish .	<b>BX61</b>
“ “ buffed . . . . .	<b>BZ10</b>	Dark “ “ “ “ . . . . .	<b>BX67</b>
Colored, light tint, relieved, sand		Colored, dark tint, no relief,	
finish, . . . . .	<b>BX12</b>	dead finish . . . . .	<b>BY14</b>
Oxidized Black, sand finish . . .	<b>BX16</b>	Statuary bronze, dead finish . . .	<b>BY65</b>

## COPPER PLATE—C.

Medium dark, transverse relief,		Medium dark, irregular relief,	
buffed . . . . .	<b>CZ17</b>	sand finish . . . . .	<b>CX18</b>
Medium dark, irregular relief,		Old metal, light, sand finish . . .	<b>CX22</b>
buffed . . . . .	<b>CZ18</b>	“ “ dark, “ “ . . . . .	<b>CX24</b>
Medium dark, transverse relief,		“ “ light, dead finish . . . . .	<b>CY22</b>
sand finish . . . . .	<b>CX17</b>	“ “ dark, “ “ . . . . .	<b>CY24</b>

## IRON—F.

Japanese bronzed, wheel finish .	<b>FW6</b>	Bronze plated, natural color,	
Copper plated, no relief, sand		buffed . . . . .	<b>FBZ10</b>
finish . . . . .	<b>FCX22</b>	Copper plated, medium dark,	
Bower-Barff; sand finish . . . .	<b>FX80</b>	transverse relief, buffed . . . .	<b>FCZ17</b>

## STEEL—S.

Japanese bronzed, wheel finish .	<b>SW6</b>	Old copper plated, light, no	
Bower-Barff, sand finish . . . .	<b>SX80</b>	relief, sand finish . . . . .	<b>SCX22</b>
Bronze plated, nat. color, buffed	<b>SBZ10</b>		

## GOLD PLATE—G.

Natural color, burnished . . . .	<b>GZ10</b>	Imit'n mercury gilt, sand finish	<b>GX12</b>
“ “ sand finish . . . . .	<b>GX10</b>	Natural color, dead finish . . . .	<b>GY10</b>

## NICKEL PLATE—N.

Nickel plated on bronze, buffed . . . . **NZ10**

## SILVER PLATE—S.

Natural color, buffed . . . . .	<b>SZ10</b>	Light oxidized, no relief, dead	
“ “ sand finish . . . . .	<b>SX10</b>	finish . . . . .	<b>SY52</b>
Light oxidized, no relief, sand		Dark oxidized, dead finish . . . .	<b>SY54</b>
finish . . . . .	<b>SX52</b>	Black oxidized high parts reliev-	
Natural color, dead finish . . . .	<b>SY10</b>	ed (platinum silver) dead finish	<b>SY55</b>

## Part IV.

---

### Locks and Latches.

## Part IV.

---

### Locks and Latches.

Section.	Page.
1. Front Door Locks, . . . . .	652-663
2. Vestibule Latches, . . . . .	653-663
3. Corridor, Room and Closet Door Locks, . . . . .	622-641
4. Communicating Door Locks, . . . . .	625-626
5. Sliding Door Locks, . . . . .	648-651, 668-670
6. Elevator Latches, . . . . .	648
7. Screen Door Latches, . . . . .	624
8. Secret Gate Latches, . . . . .	616
9. Store Door Locks, . . . . .	664-666
10. Cabinet Locks, . . . . .	674-678
11. Hotel Locks, . . . . .	641-644
12. Office Locks, . . . . .	645-647, 669
13. Asylum Locks, . . . . .	672-673
<hr/>	
14. Night Latches, . . . . .	615-616, 627-667
15. Flush Rim Locks, . . . . .	670-671
16. Knob Locks, . . . . .	618-622
17. Dead Locks, . . . . .	617-618, 628-630
18. Dead Bolts, . . . . .	630-632
19. Duplex Locks, . . . . .	667-669

The Catalogue Numbers in this Part are those of the Yale & Towne Manufacturing Company.



42

### Yale Rim Night Latch.

The leading Night Latch of the world.

No. 42, Case,  $2\frac{3}{8} \times 3\frac{1}{2}$  inches—Old Copper Finish, . . . each, \$3.90  
 Bolt, Cylinder and Knob—Bronze. Reversible—For Doors of either Hand.



042

### Yale Rim Night Latch.

An earlier and popular model of the No. 42.

No. 042, Case,  $2\frac{3}{8} \times 3\frac{5}{8}$  inches—Japanned Iron, . . . each, \$3.70  
 Bolt, Cylinder and Knob—Bronze. Reversible—For Doors of either Hand.



54

### Yale Rim Night Latch.

No. 54, Case,  $2 \times 3\frac{5}{8}$  inches—Solid Bronze, Buffed, . . . each, \$7.70  
 Bolt, Cylinder and Knob—Bronze. Reversible—For Doors of either Hand.

See Note as to Method of Pricing, page 33. Cuts  $\frac{1}{4}$  size.



52N



### Yale Rim Night Latch.

No. 52N, Case,  $2\frac{3}{8} \times 2\frac{5}{8}$  inches—Solid Bronze, Buffed, . . . each, \$7.00  
Bolt, Cylinder and Knob—Bronze. Reversible—For Doors of either Hand.

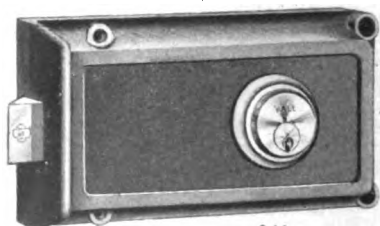

841



### Yale Rim Night Latch.

Specially adapted for Iron Fire-proof Doors in Office Buildings, Theatres, etc.  
No. 841, Case,  $4\frac{1}{8} \times 7$  inches—Japanned Iron, . . . each, \$21.00  
Bolt and Cylinder—Bronze. Not Reversible—Specify Hand when ordering.



4305

### Secret Gate Latch.

Operated by Lever from bottom of case.  
Case,  $2 \times 2\frac{1}{2}$  inches. Bolt—Bronze.  
Reversible—For Doors of either Hand.

No. 4305. Japanned Iron, each, \$1.00  
" 4310. Buffed Bronze, " 2.00

See Note as to Method of Pricing, page 33. Cuts  $\frac{1}{4}$  Size

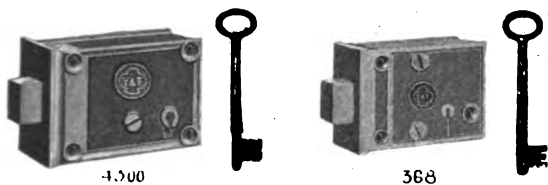

4300

368

Rim Dead Locks.

No. 4300, Case,  $2\frac{1}{2} \times 3\frac{3}{8}$  ins.—Japanned Iron. Bolt—Bronze, each, \$1.10  
 No. 368, “  $2\frac{1}{4} \times 3$  “ “ “ “ “ Brass, “ 1.20  
 3 Tumblers. Reversible—For Doors of either Hand.



32

Yale Rim Dead Lock.

No. 32, Case,  $2\frac{3}{8} \times 3\frac{5}{8}$  inches—Japanned Iron, . . . . . each, \$5.70  
 Bolt, Cylinder and Knob—Bronze. Reversible—For Doors of either Hand.

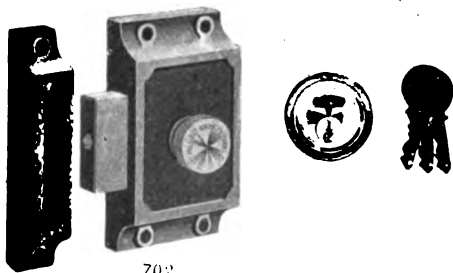

702

Yale Rim Dead Locks.

No. 702, Case,  $5 \times 2\frac{1}{2}$  inches—Japanned Iron, . . . . . each, \$7.25  
 No. 712, “  $4 \times 2\frac{1}{2}$  “ “ “ “ “ “ “ “ “ 6.60  
 Bolt, Cylinder and Knob—Bronze. Reversible—For Door of either Hand.

See Note as to Method of Pricing, page 33. Cuts  $\frac{1}{4}$  Size.

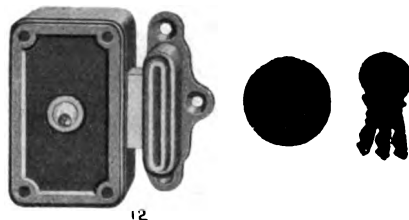

12

## Yale Rim Dead Locks.

No. 4, Case, 5 × 3 inches—Japanned Iron,	each, \$8 50
No. 12, “ 4 × 2½ “ “ “	“ “ 7.00

Bolt and Cylinders—Bronze. Reversible—For Doors of either Hand.

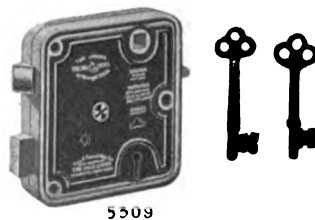

5309

## Vulcan Jr. Rim Knob Locks.

Wrought Metal.

No. 5309, Case, 3¾ × 2¾ ins.	Brass Bolts.	Solid Steel Key,	each, \$ 90
No. 5310, “ “	Iron “ “	“ “ “ “	75
No. 5311, “ “	“ “	Tinned Mal. “ “	60

Case—Enameled Steel, with Stop. Reversible—For Doors of either Hand.

See Note as to Method of Pricing, page 33. Cuts ¼ Size.

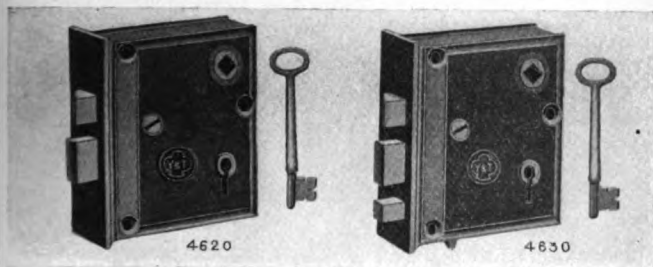

Rim Knob Locks.

No. 4620, Case,  $4\frac{1}{4} \times 3\frac{3}{8}$  inches. 3 Tumblers, . . . each, \$1.60  
 No. 4630, " " " With Slide Bolt, . . . " 1.80

Case—Japanned Iron. Bolts and Hub—Bronze. Reversible—For  
 Doors of either Hand.

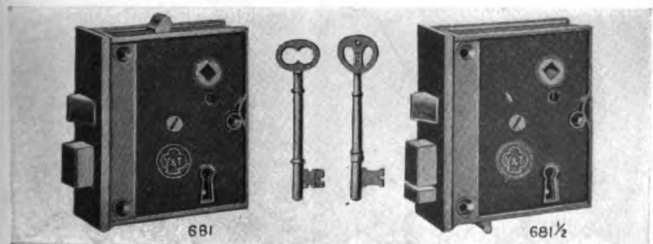

Rim Knob Locks.

Master-keyed, in one group of 50 locks or less, all different.

No. 681, Case,  $4\frac{1}{8} \times 3\frac{1}{4}$  inches, with Stop, . . . each, \$1.20  
 No. 681 1/2, " " " " Slide Bolt, . . . " 1.30

Case—Japanned Iron. Bolts and Hub—Brass. Reversible—For  
 Doors of either Hand,

*See Note as to Method of Pricing, page 33. Cuts 1/4 Size.*



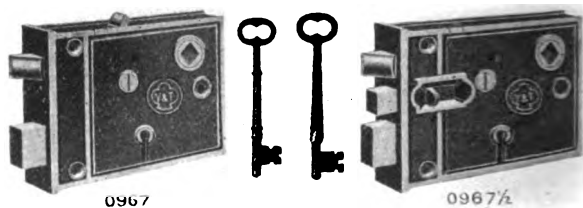

## Rim Knob Locks.

No. 0967, . Case,  $3\frac{1}{4} \times 4\frac{1}{4}$  inches, with Stop, . . . each, \$ .85  
 No. 0967  $\frac{1}{2}$ , " " " " " Slide Bolt, . . . " 1.05

Case—Japanned Iron. Bolts—Brass. Reversible—For Doors of either Hand.

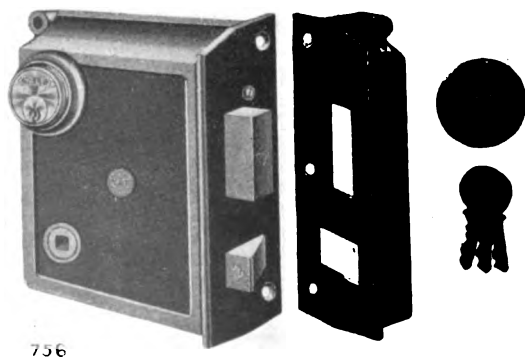

756

## Yale Rim Knob Lock.

No. 756, Case,  $6\frac{1}{2} \times 4\frac{1}{4}$  inches—Japanned Iron, . . . each, \$27.40

Bolts, Hub and Cylinders—Bronze. Not Reversible—Specify Hand when ordering.

See Note as to Method of Pricing, page 33. Cuts  $\frac{1}{4}$  Size.



1783

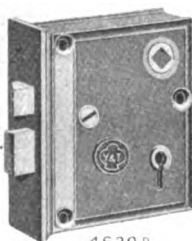

4620B



Rim Knob Locks.

No. 1783, Case,  $4\frac{1}{8} \times 3\frac{3}{8}$  inches—Brass. Bolts, Strike and all interior parts—Brass, . . . . . each, \$3.25

No. 4620B, Case,  $4\frac{1}{4} \times 3\frac{3}{8}$  inches—Bronze. Bolts, Strike and all interior parts—Bronze, . . . . . “ 4.75

Reversible - For Doors of either Hand.



1770



Rim Knob Lock.

No. 1770, Case,  $5\frac{1}{2} \times 4$  inches—Bronze or Brass. Bolts, Cover and Hub—Bronze or Brass. Three Tumblers. Anti-Friction Latch Bolt, . . . . . each, \$20.00

Not Reversible—Specify Hand when ordering.

See Note as to Method of Pricing, page 33. Cuts  $\frac{1}{4}$  Size.

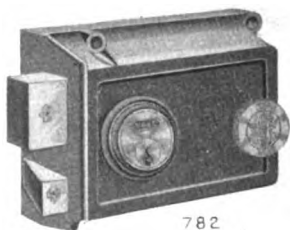

782



### Yale Rim Night Latch and Lock.

No. 782, Case,  $4\frac{1}{8} \times 5$  inches—Japanned Iron, . . . each, \$14.65  
Bolts, Cylinders and Knob—Bronze. Not Reversible—Specify  
Hand when ordering.

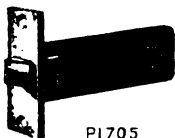

P1705



P1706

### Mortise Knob Latches.

No. P1705, Case,  $1\frac{1}{4} \times 3\frac{1}{4} \times \frac{1}{2}$  inches; Backset,  $2\frac{1}{2}$  inches, each, \$ .60

No. P1706, "  $2 \times 1\frac{1}{2} \times \frac{1}{2}$  " " " " " " 1.10

Case—Japanned Iron. Front and Bolt—Bronze. P1706 priced with  
T-Handle and Plate. Reversible—For Doors of either Hand.

### Vulcan Mortise Knob Latch.

All Wrought Metal.

Case,  $2\frac{1}{4} \times 3\frac{3}{8} \times \frac{5}{8}$  ins.—Bronze Plated Steel.

Front, Bolt and Strike—Bronze.

Backset,  $2\frac{3}{4}$  inches.

Reversible—For Doors of either Hand.

No. P2200. Latch only, . . . each, \$1.50

No. P2200. With W56 Knobs  
and Roses, . . . . . each, \$3.50



P2200

See Note as to Method of Pricing, page 33. Cuts  $\frac{1}{4}$  Size.

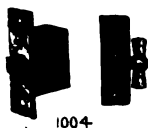

1004



1009

Mortise Knob Latches.

- |           |   |                     |   |
|-----------|---|---------------------|---|
| No. 1004, | Case, $1\frac{1}{4} \times 7\frac{7}{8} \times \frac{1}{2}$ inches—Bronze.        | Backset,            |   |
|           |   | $\frac{1}{2}$ inch. | With T-Handle, . . . . .                            |
|           |   |                     | each, \$1.50  |
| No. 1009, | Case, $1\frac{3}{8} \times 1\frac{1}{8} \times \frac{3}{8}$ inches—Japanned Iron, | Backset,            | $\frac{3}{4}$ inch. With T-Handle. . . . .          |
|           |   |                     | “ 1.50  |
| No. 1010, | Case, $1\frac{5}{8} \times 1\frac{1}{8} \times \frac{3}{8}$ inches—Japanned Iron, | Backset,            | $\frac{3}{4}$ inch. With Lever Handle, . . . . .    |
|           |   |                     | “ 1.60  |
| No. 1008, | Case, $2\frac{1}{4} \times 1\frac{1}{2} \times \frac{1}{2}$ inches—Japanned Iron, | Backset,            | 1 inch. With T-Handle, . . . . .                    |
|           |   |                     | “ 2.00  |
| No. 1002, | Case, $3\frac{1}{4} \times 2\frac{1}{4} \times \frac{5}{8}$ inches—Japanned Iron, | Backset,            | $1\frac{1}{2}$ inches. With Knobs and Roses. “ 3.40 |

Front, Bolt, Hub and Strike—Bronze. Reversible—For Doors of either Hand.



1000



1001

Mortise Knob Latches.

- |            |   |                                 |              |
|------------|---|---------------------------------|--------------|
| No. 1000,  | Case, $2\frac{1}{2} \times 3\frac{1}{2} \times \frac{3}{4}$ inches. | Backset, $2\frac{3}{4}$ inches, | each, \$2.30 |
| No. 1000R, | Same as No. 1000, but with Rabbeted Front,                          |                                 | “ 3.10       |
| No. 1001,  | Case, $2\frac{3}{4} \times 2\frac{3}{4} \times \frac{5}{8}$ inches. | Backset, 2 inches,              | “ 2.20       |

Case—Japanned Iron. Front, Bolt, Strike and Hub—Bronze.  
Reversible—For Doors of either Hand.

See Note as to Method of Pricing, page 33. Cuts  $\frac{1}{4}$  Size.



### Mortise Knob Latch.

With Rabbeted Front.

Case,  $3\frac{1}{2} \times 1\frac{1}{4} \times \frac{5}{8}$  inches—Japanned Iron.

Front, Bolt, Hub and Strike—Bronze.

Backset,  $\frac{3}{4}$  inch. Reversible.

No. P1700R, . . . . . each, \$2.40



### Mortise Locking Latch.

For Cabinet Doors.

Case,  $3\frac{1}{8} \times 1\frac{1}{4} \times \frac{3}{8}$  inches—Bronze.

Front, Bolt, Hub and Strike—Bronze.

Backset,  $\frac{3}{4}$  inch. Not Reversible.

No. 917, with Plate and Knob, . . . . . each, \$3.00



### Mortise Dead-Locking Latch.

For Screen Doors.

Case,  $2\frac{1}{4} \times 1\frac{1}{2} \times \frac{1}{2}$  inches—Japanned Iron.

Front, Bolt, Hub and Strike—Bronze.

Backset, 1 inch. Reversible.

No. 1012, with Lever Handles, Knob and  
Plates, . . . . . each, \$3.80



### Mortise Knob Latch.

With Thumb Bolt.

Case,  $3 \times 3\frac{1}{4} \times \frac{5}{8}$  inches—Japanned Iron.

Front, Bolts and Strike—Bronze.

Backset,  $2\frac{3}{4}$  inches. Reversible.

No. P118, Latch only, . . . . . each, \$1.70

No. P118, with Thumb-piece, . . . . . " 2.50

See Note as to Method of Pricing, page 33. Cuts  $\frac{1}{4}$  Size.

Vulcan Mortise Knob Latch.

All Wrought Metal.

Case,  $4 \times 3\frac{3}{8} \times \frac{9}{16}$  inches—Bronze Plated Steel.

Front, Bolts and Strikes—Bronze.

Backset,  $2\frac{3}{4}$  inches.

Reversible—For Doors of either Hand.

No. P2405, . . . . . each, \$2.40



P2405

Mortise Knob Latch.

Case,  $4\frac{1}{2} \times 3\frac{1}{2} \times \frac{5}{8}$  inches—Japanned Iron.

Front, Bolts, Hub and Strike—Bronze.

Backset,  $2\frac{3}{4}$  inches.

Reversible—For Doors of either Hand.

No. 1505, . . . . . each, \$2.65

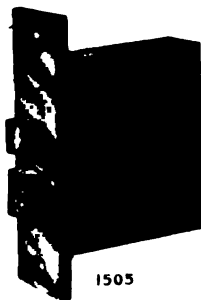

1505

Mortise Knob Latches.

For Communicating Doors.

Case,  $4\frac{1}{2} \times 3\frac{1}{2} \times \frac{9}{16}$  inches—Japanned Iron.

Front, Bolts and Strike—Bronze.

Backset,  $2\frac{3}{4}$  inches.

Reversible—For Doors of either Hand.

No. P118½, Latch only, . . . each, \$3.10

No. P118½, with Thumb-piece, “ 3.90

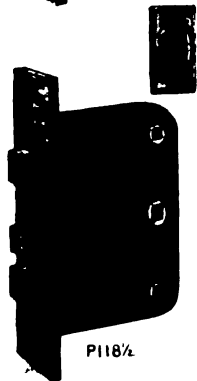

P118½



### Vulcan Mortise Knob Latch.

All Wrought Metal.

For Communicating Doors.

Case,  $4 \times 3\frac{3}{8} \times \frac{1}{8}$  inches—Bronze Plated Steel.

Front, Bolts and Strike—Bronze.

Backset,  $2\frac{3}{4}$  inches.

Reversible—For Doors of either Hand.

No. P2400, . . . . . each, \$3.30

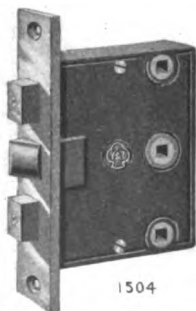

### Mortise Knob Latch.

For Communicating Doors.

Case,  $4\frac{1}{2} \times 3\frac{1}{2} \times \frac{5}{8}$  inches—Japanned Iron.

Front, Bolts, Hub and Strike—Bronze.

Backset,  $2\frac{3}{4}$  inches.

Reversible—For Doors of either Hand.

No. 1504, . . . . . each, \$3.30

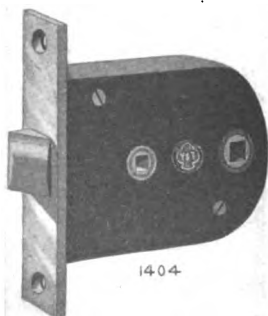

### Horizontal Mortise Knob Latch.

With Dead-Locking Thumb-pieces.

Case,  $3\frac{3}{4} \times 5\frac{3}{8} \times \frac{7}{8}$  inches—Japanned Iron.

Front, Bolt, Hub and Strike—Bronze.

Backset } Thumb-knob,  $2\frac{1}{4}$  inches.  
          } Knobs, . . .  $4\frac{3}{4}$  " "

Reversible—For Doors of either Hand.

No. 1404, . . . . . each, \$6.60

See Note as to Method of Pricing, page 33. Cuts  $\frac{1}{4}$  Size.

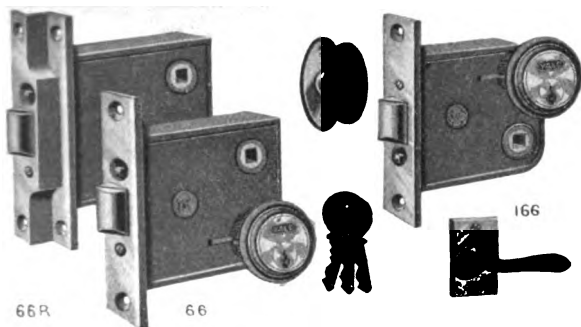

**Yale Mortise Night Latches.**

The Leading Mortise Night Latches of the World.

- |           |   |               |
|-----------|---|---------------|
| No. 66,   | Case, $3\frac{1}{4} \times 3\frac{1}{2} \times \frac{3}{4}$ inches. Backset, $2\frac{3}{4}$ inches<br>With Knob and Rose. Reversible, . . . . . | each, \$ 7.90 |
| No. 66R,  | Same as No. 66, but with Rabbeted Front and Not<br>Reversible, . . . . .  | “ 10.80       |
| No. 66N,  | Case, $3\frac{1}{2} \times 2\frac{3}{4} \times \frac{3}{4}$ inches. Backset, 2 inches.<br>With Knob and Rose. Reversible, . . . . .             | “ 7.90        |
| No. 166,  | Case, $2\frac{3}{4} \times 3 \times \frac{5}{8}$ inches. Backset, $2\frac{1}{2}$ inches.<br>With Knob and Rose. Reversible, . . . . .           | “ 7.90        |
| No. 167,  | Case, $2\frac{3}{4} \times 3 \times \frac{5}{8}$ inches. Backset, $2\frac{1}{2}$ inches.<br>With Lever Handle and Plate. Reversible, . . . . .  | “ 7.90        |
| No. 466,  | Case, $4\frac{3}{4} \times 3\frac{5}{8} \times 1$ inches. Backset, $2\frac{3}{4}$ inches.<br>With Knob and Rose. Reversible, . . . . .          | “ 12.65       |
| No. 466R, | Same as No. 466, but with Rabbeted Front, and<br>Not Reversible, . . . . .  | “ 15.50       |

Case—Japanned Iron. Front, Bolts, Cylinder, Hub and Strike—Bronze.

See Note as to Method of Pricing, page 33. Cuts  $\frac{1}{4}$  Size.



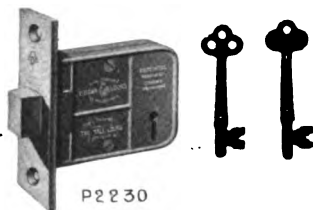

### Vulcan Mortise Dead Lock.

All Wrought Metal.

Master-keyed, in one group of 1920 Locks, or less, all different.

No. P2230, Case,  $2\frac{1}{4} \times 3\frac{3}{8} \times \frac{1}{8}$  inches. Backset,  $2\frac{3}{4}$  inches, each, \$2.00

Case—Bronze Plated Steel. Front, Bolt and Strike—Bronze. 3 Tumblers.  
Reversible—For Doors of either Hand.

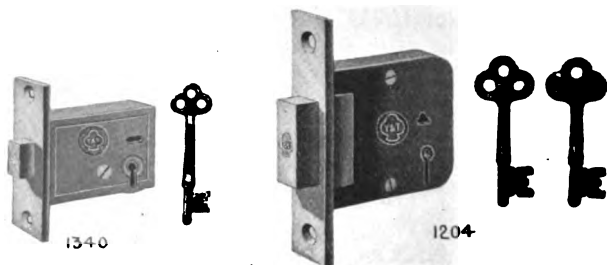

### Mortise Dead Locks.

No. 1340, Case,  $1\frac{3}{4} \times 2\frac{1}{2} \times \frac{1}{2}$  inches. Backset, 2 inches, each, \$2.30

No. 1300\*, "  $2\frac{1}{8} \times 3\frac{1}{2} \times \frac{5}{8}$  " "  $2\frac{3}{4}$  " " 2.60

No. 1308, "  $2\frac{1}{2} \times 1\frac{1}{2} \times \frac{1}{2}$  " " 1 " " 2.50

No. 1204†, "  $2\frac{7}{8} \times 3\frac{1}{2} \times \frac{3}{4}$  " "  $2\frac{3}{4}$  " " 4.40

\* Master-keyed, in one group of 1920 Locks, or less, all different.

† " " " 2400 " " "

Case—Japanned Iron. Front, Bolt and Strike—Bronze. Three Tumblers.  
Reversible—For Doors of either Hand.

See Note as to Method of Pricing, page 33. Cuts  $\frac{1}{4}$  Size.

Mortise Dead Lock.

Master-keyed in one group of 21840 locks, or less, all different.

Case,  $3\frac{3}{4} \times 3 \times \frac{3}{4}$  inches—Japanned Iron.

Front, Bolt and Strike—Bronze.

Backset, 2 ins. Reversible.

No. 1200, . . . each, \$6.60

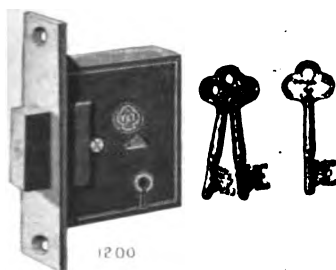

Yale

Mortise Dead Locks.

Case, size as below—Japanned Iron.

Front, Bolt, Cylinder and Strike—Bronze.

No. 344,  $2\frac{3}{8} \times 3\frac{5}{8} \times \frac{3}{4}$  ins. Backset,  $2\frac{3}{4}$  ins. Reversible, . . . each, \$7.25

No. 344R, Rabbeted Front, Not Reversible, each, . . . \$10.00

No. 344N,  $2\frac{3}{8} \times 3\frac{1}{8} \times \frac{3}{4}$  ins. Backset,  $2\frac{1}{4}$  ins. Reversible, . . . each, \$7.25

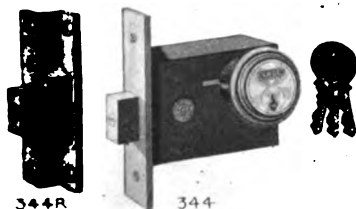

Yale

Mortise Dead Lock.

Case,  $3 \times 3\frac{5}{8} \times \frac{3}{4}$  inches—Japanned Iron. Front, Bolt, Hub and Strike—Bronze.

Backset,  $2\frac{3}{4}$  ins. Not Reversible.

No. 348, . . . each, \$9.90

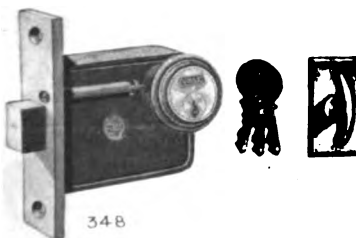

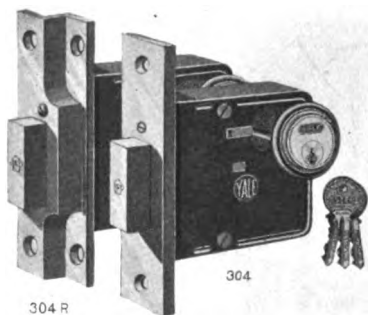

304 R

### Yale Mortise Dead Locks.

Case,  $3\frac{3}{4} \times 3\frac{7}{8} \times 1\frac{1}{8}$  inches—Japanned Iron.

Front, Bolt, Cylinder and Strike—Bronze.

Backset,  $2\frac{3}{4}$  inches.

No. 304, Reversible, each, . . . \$8.00

No. 304R, Rabbeted Front, Not Reversible, . . . each, \$10.80

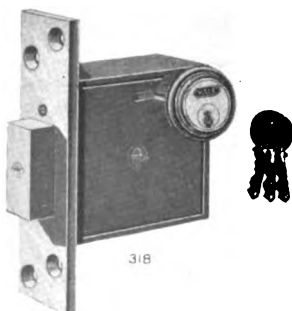

318

### Yale Mortise Dead Lock.

Case,  $4 \times 3\frac{7}{8} \times 1\frac{1}{4}$  inches—Japanned Iron.

Front, Bolt, Cylinder and Strike—Bronze.

Backset,  $2\frac{3}{4}$  inches.

Reversible—For Doors of either Hand.

No. 318, . . . each, \$10.60

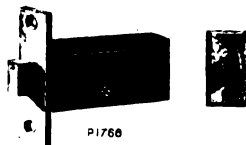

P1766

### Mortise Bolt.

Case,  $1\frac{5}{8} \times 3\frac{3}{8} \times \frac{5}{8}$  inches—Japanned Iron.

Backset,  $2\frac{3}{8}$  inches.

No. P1766, with Thumb-piece, . . . each, \$1.80

No. P1766, Front, Bolt, Hub and Strike—Bronze. Reversible—For Doors of either Hand.

See Note as to Method of Pricing, page 33. Cuts  $\frac{1}{4}$  Size.

Vulcan Mortise Bolt.

All Wrought Metal.

Case,  $2\frac{1}{4} \times 3\frac{3}{8} \times \frac{9}{16}$  inches — Bronze Plated Steel.

Front, Bolt and Strike — Bronze.

Backset,  $2\frac{3}{4}$  inches.

Reversible—For Doors of either Hand.

No. P2205, with Thumb-piece, each, \$3.00

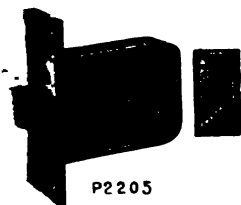

P2205

Mortise Bolt.

Case,  $1\frac{1}{2} \times 3\frac{1}{4} \times \frac{5}{8}$  inches — Japanned Iron.

Front, Bolt, Hub and Strike — Bronze.

Backset,  $2\frac{5}{8}$  inches.

Reversible—For Doors of either Hand.

No. 1060, with Thumb-piece, each, \$2.40



1060

Mortise Bolt.

Case,  $1\frac{3}{8} \times 1\frac{1}{2} \times \frac{3}{8}$  inches — Japanned Iron.

Front, Bolt, Hub and Strike — Bronze.

Backset,  $1\frac{1}{8}$  inches.

Reversible—For Doors of either Hand.

No. 1049, with Thumb-piece, each, \$1.90



1049

Mortise Bolt.

Case,  $2\frac{1}{4} \times 1\frac{1}{2} \times \frac{1}{2}$  inches — Japanned Iron.

Front, Bolt, Hub and Strike — Bronze.

Backset, 1 inch.

Reversible—For Doors of either Hand.

No. 1048, with Thumb-piece, each, \$2.60



1048



1047



1050



## Mortise Bolts.

- No. 1047, Case,  $2\frac{1}{2} \times 2 \times \frac{3}{8}$  inches. Backset,  $1\frac{1}{2}$  inches—  
 With Thumb-piece, . . . . . each, \$3.00  
 No. 1050, Case,  $2 \times 3\frac{1}{2} \times \frac{1}{4}$  inches. Backset,  $2\frac{3}{4}$  inches—  
 With Thumb-piece, . . . . . " 3.00

Case—Japanned Iron. Front, Bolt, Hub and Strike—Bronze  
 Reversible—For Doors of either Hand.



1640R



1640



## Mortise Knob Locks.

- No. 1640, Case,  $3\frac{1}{2} \times 1\frac{1}{2} \times \frac{1}{2}$  inches. Backset, 1 inch.  
 Reversible—For Doors of either Hand. Lock only, each, \$2.20  
 Lock with Lever Handles and Plates, . . . . . " 4.80  
 No. 1640R, Same as No. 1640, but with Rabbeted Front, and  
 Not Reversible. Lock only, . . . . . " 5.00  
 Lock with Lever Handles and Plates, . . . . . " 7.60

Case—Japanned Iron. Front, Bolts, Hub and Strike—Bronze.

See Note as to Method of Pricing, page 33. Cuts  $\frac{1}{4}$  Size.

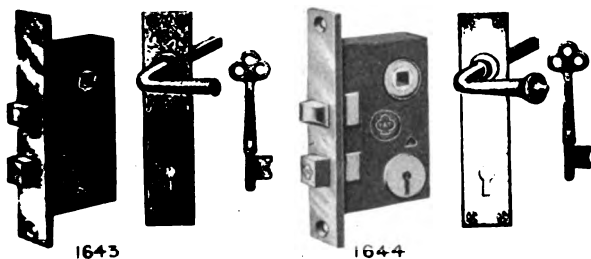

Mortise Knob Locks.

- No. 1643, Case,  $3\frac{1}{2} \times 1\frac{1}{2} \times \frac{1}{2}$  ins. Backset, 1 in.—Lock only, each, \$2.60  
 Lock with Lever Handles and Plates . . . . . 5.20  
 No. 1644, Case,  $3\frac{1}{2} \times 2\frac{1}{8} \times \frac{1}{2}$  ins. Backset,  $1\frac{1}{2}$  ins.—Lock only, “ 2.80  
 Lock with Lever Handles and Plates . . . . . “ 6.00

Case—Japanned Iron. Front, Bolts, Hub and Strike—Bronze.  
 Reversible—For Doors of either Hand.

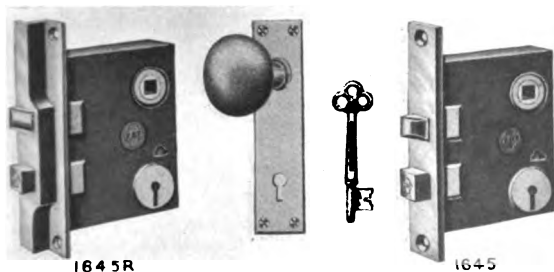

Mortise Knob Locks.

- No. 1645, Case,  $3\frac{1}{2} \times 2\frac{5}{8} \times \frac{1}{2}$  ins. Backset, 2 ins.—Reversible.  
 Lock only, . . . . . each, \$2.80  
 Lock with Plates and Knobs, . . . . . “ 6.00  
 No. 1645R, Same as No. 1645, but with Rabbeted Front, and  
 Not Reversible, Lock only, . . . . . “ 5.60  
 Lock with Plates and Knobs, . . . . . “ 8.90

Case—Japanned Iron. Front, Bolts, Hub and Strike—Bronze.

See Note as to Method of Pricing, page 33. Cuts  $\frac{1}{4}$  Size.

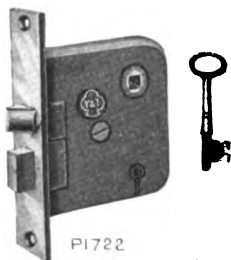

P1722

**Mortise Knob Lock.**

Case,  $3\frac{1}{2} \times 3\frac{1}{4} \times \frac{1}{2}$  inches—  
Japanned Iron.  
Front, Bolts and Strike—**Bronze.**  
Backset,  $2\frac{1}{2}$  inches.  
Reversible—For Doors of either  
Hand.  
No. P1722, . . . each, \$1.00

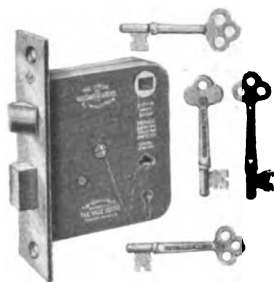

P3330

**Vulcan, Jr.,  
Mortise Knob Lock.**

**Wrought Metal.**

Master-keyed, No. P3310, in one  
group of 30, and No. P3330, in  
one group of 192 locks, or less,  
all different.

Case,  $3\frac{1}{2} \times 3\frac{1}{4} \times \frac{1}{2}$  inches—  
Bronze Plated Steel.  
Front, Bolts and Strike—**Bronze.**  
Backset,  $2\frac{5}{8}$  inches  
Reversible—For Doors of either  
Hand.  
No. P3310, 1 Tumbler, each, \$1.50  
No. P3330, 3 " " " 1.90

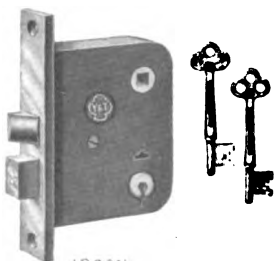

1620N

**Mortise Knob Lock.**

Master-keyed, in one group of 12  
locks, or less, all different.  
Case,  $3\frac{3}{4} \times 2\frac{7}{8} \times \frac{5}{8}$  inches—  
Japanned Iron.  
Front, Bolts, Hub and Strike—  
**Bronze.**  
Three Tumblers.  
Backset,  $2\frac{1}{4}$  inches.  
Reversible—For Doors of either  
Hand.  
No. 1620N, . . . each, \$2.75

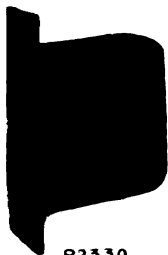

P2330



Vulcan  
Mortise Knob Lock.

All Wrought Metal.

Master-keyed, in one group of 1920 locks, or less, all different.

Case,  $3\frac{1}{2} \times 3\frac{3}{8} \times \frac{1}{8}$  inches—  
Bronze Plated Steel.

Front, Bolts and Strike—Bronze.  
Three Tumblers.

Backset,  $2\frac{3}{4}$  inches. Reversible.

No P2330, . . . each, \$2.40

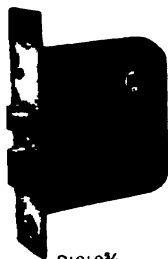

P1918 $\frac{3}{4}$



Mortise Knob Lock.

Master-keyed, No. P1918, in one group of 250, and No. P1918 $\frac{3}{4}$ , in one group of 300 locks, or less, all different.

Case,  $3\frac{1}{2} \times 3\frac{1}{4} \times \frac{5}{8}$  inches—  
Japanned Iron.

Front, Bolts and Strike—Bronze.

Backset,  $2\frac{1}{2}$  inches. Reversible.

No. P1918, 1 Tumbler, each, \$1.40

No. P1918 $\frac{3}{4}$ , 3 " " " 1.75

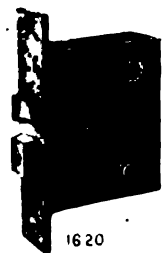

1620



Mortise Knob Lock.

Master-keyed, in one group of 1920 locks, or less, all different.

Case,  $3\frac{1}{2} \times 3\frac{1}{4} \times \frac{5}{8}$  inches—  
Japanned Iron.

Front, Bolts, Hub and Strike—  
Bronze.

Three Tumblers.

Backset,  $2\frac{3}{4}$  inches Reversible.

No. 1620, . . . each, \$2.50



P2918 $\frac{3}{4}$ **Mortise Knob Lock.**

Master-keyed, No. P2918, in a group of 250, and No. P2918 $\frac{3}{4}$  in one group of 300 locks, or less, all different.

Case,  $4 \times 3\frac{1}{4} \times \frac{5}{8}$  inches—Japan Iron.

Front, Bolts and Strike—Bronze. Backset,  $2\frac{1}{2}$  inches. Reversible.

No. P2918, 1 Tumbler, each, \$2.00

No. P2918 $\frac{3}{4}$ , 3 " " 2.00



P2430

**Vulcan Mortise Knob Lock.**

All Wrought Metal.

Master-keyed, in one group of 192 locks, or less, all different.

Case,  $4 \times 3\frac{3}{8} \times \frac{9}{16}$  inches—Bronze Plated Steel.

Front, Bolt and Strike—Bronze.

Three Tumblers.

Backset,  $2\frac{3}{4}$  inches. Reversible.

No. P2430, . . . each, \$2.50



1500

**Mortise Knob Lock.**

Master-keyed, in one group of 192 locks, or less, all different.

Case,  $4\frac{1}{4} \times 3\frac{1}{2} \times \frac{5}{8}$  inches—Japanned Iron.

Front, Bolts, Hub and Strike—Bronze.

Three Tumblers.

Backset,  $2\frac{3}{4}$  inches. Reversible.

No. 1500, . . . each, \$3.00

See Note as to Method of Pricing, page 33. Cuts  $\frac{1}{4}$  Size.

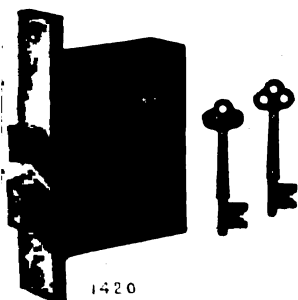

1420

Mortise Knob Lock.

Master-keyed, in one group of 1920 Locks, or less, all different.

Case,  $4\frac{1}{4} \times 3 \times \frac{5}{8}$  inches—  
Japanned Iron.

Front, Bolts, Hub and Strike—  
Bronze.

Three Tumblers.

Backset,  $2\frac{1}{4}$  inches. Reversible.

No. 1420, . . . each, \$3.00

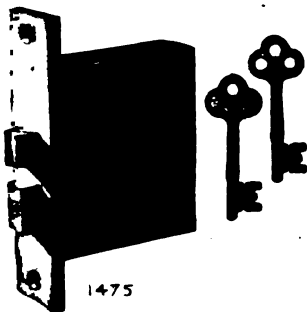

1475

Mortise Knob Lock.

Master-keyed, in one group of 2400 locks, or less, all different.

Case,  $4\frac{1}{4} \times 3\frac{1}{2} \times \frac{3}{4}$  inches—  
Japanned Iron.

Front, Bolts, Hub and Strike—  
Bronze.

Five Tumblers.

Backset,  $2\frac{3}{4}$  inches. Reversible.

No. 1475, . . . each, \$5.20

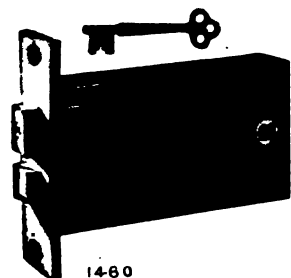

1460

Mortise Knob Lock.

Case,  $3\frac{1}{4} \times 5\frac{1}{2} \times \frac{5}{8}$  inches—  
Japanned Iron.

Front, Bolts, Hub and Strike—  
Bronze.

Three Tumblers. Reversible.

Backset { Hub, 5 inches.  
          { Keyhole, 2 inches.

No. 1460, . . . each, \$4.75

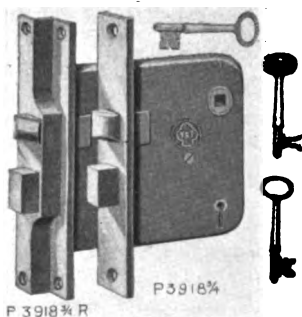
**Mortise Knob Lock.**

Master-keyed, in one group of 2 locks, or less, all different.

Case,  $4\frac{1}{2} \times 3\frac{1}{2} \times \frac{1}{2}$  inches—Japanned Iron.

Front, Bolts and Strike—Bronze  
Backset,  $2\frac{1}{2}$  inches.

No. P3918, 1 Tumbler, Reversible, . . . . . each, \$2.60

No. P3918R, Rabbeted Front, Not Reversible, . . . . . each, 5.00

No. P3918 1/4, 3 Tumblers, Reversible, . . . . . each, 5.00

No. P3918 1/4 R, Rabbeted Front, Not Reversible, each, 5.80

**Mortise Knob Lock.**

Master-keyed, in one group of 2 locks, or less, all different.

Case,  $5 \times 3\frac{3}{4} \times \frac{5}{8}$  inches—Japanned Iron.

Front, Bolt and Strike—Bronze.  
Backset, 3 inches. Reversible.

No. P4918, 1 Tumbler, each, \$3.80

No. P4918 1/4, 3 " " " 4.25

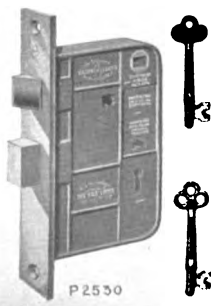
**Vulcan Mortise Knob Lock.**

All Wrought Metal.

Master-keyed, in one group of 19 locks, or less, all different.

Case,  $5 \times 3\frac{3}{8} \times \frac{9}{16}$  inches—Bronze Plated Steel.

Front, Bolt and Strike—Bronze.

Backset,  $2\frac{3}{4}$  inches. Reversible.

No. P2530, 3 Tumblers, each, \$4.00

See Note as to Method of Pricing, page 33. Cuts 1/4 Size.

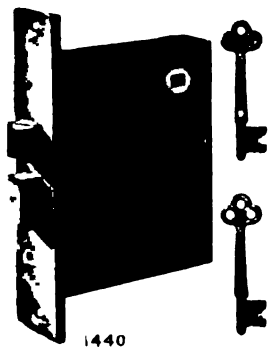

**Mortise Knob Lock.**

Master-keyed in one group of 1920 locks, or less, all different.

Case,  $5 \times 3\frac{1}{2} \times \frac{5}{8}$  inches—Japanned Iron.

Front, Bolts, Strike and Hub—Bronze.

Backset,  $2\frac{3}{4}$  inches

Three Tumblers.

Reversible—For Doors of either Hand.

No. 1440, . . . each, \$4.75

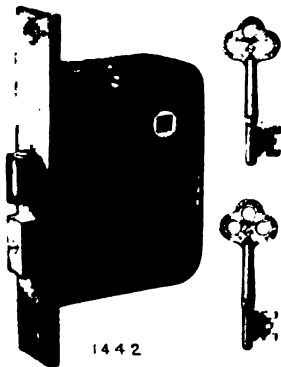

**Mortise Knob Lock.**

Master-keyed in one group of 2400 locks, or less, all different.

Case,  $5 \times 4 \times \frac{3}{4}$  inches Japanned Iron.

Front, Bolts, Strike and Hub—Bronze.

Backset, 3 inches.

Three Tumblers.

Reversible—For Doors of either Hand.

No. 1442, . . . each, \$5.50

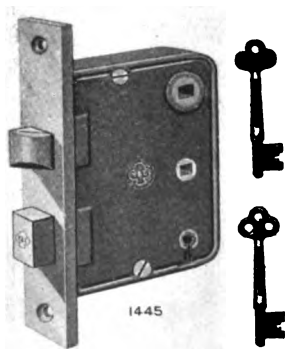

### Mortise Knob Lock.

Master-keyed, in one group of 192 locks, or less, all different.

Case,  $4\frac{3}{4} \times 3\frac{1}{2} \times \frac{1}{4}$  inches—Japanned Iron.

Front, Bolts, Hub and Strike—Bronze.  
Backset,  $2\frac{3}{4}$  inches.

Three Tumblers.

Reversible—For Doors of either Hand.

No. 1445 . . . each, \$4.45

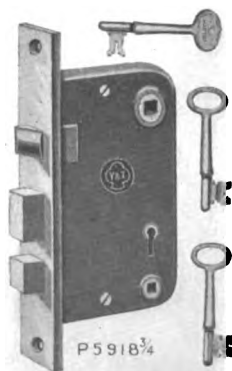

### Mortise Knob Lock.

Master-keyed, No. P5918  $\frac{1}{2}$ , in one group of 250, and No. P5918  $\frac{3}{4}$ , in one group of 300 locks, or less, all different.

Case,  $5 \times 3\frac{1}{2} \times \frac{5}{8}$  inches—Japanned Iron.

Front, Bolts and Strike—Bronze.

Backset,  $2\frac{1}{2}$  inches.

Reversible—For Doors of either Hand.

No. P5918  $\frac{1}{2}$ , 1 Tumbler, each, \$4.15

No. P5918  $\frac{3}{4}$ , 3 " " " 4.45

See Note as to Method of Pricing, page 33. Cuts  $\frac{1}{4}$  Size.



P2535

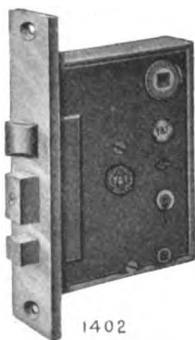

1402



### Mortise Knob Locks.

Master-keyed, in one group of 1920 locks, or less, all different.

No. P2535, Case,  $5 \times 3\frac{3}{8} \times 1\frac{9}{16}$  inches—Bronze Plated Steel, . each, \$4.50

No. 1402, "  $5 \times 3\frac{1}{2} \times \frac{5}{8}$  " —Japanned Iron, . " 4.75

Case—As above. Front, Bolts and Strike—Bronze. Three Tumblers.  
Backset,  $2\frac{3}{4}$  inches. Reversible—For Doors of either Hand.



P1793



### Hotel Mortise Knob Lock.

Master-keyed in one group of 300 locks, or less, all different.

Case,  $5 \times 3\frac{1}{2} \times \frac{5}{8}$  inches—Japanned Iron.

Front, Bolts, Hub and Strike—Bronze. Three Tumblers.

Backset,  $2\frac{3}{4}$  inches.

Not Reversible—Specify Hand when ordering.

No. P1793, . . . each, \$4.25

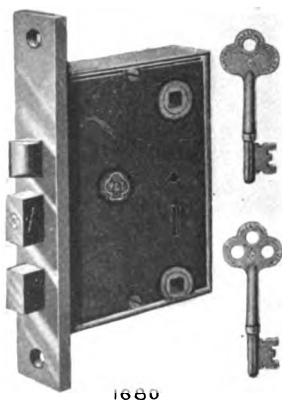

1680



1680 1/2

### Hotel Mortise Knob Locks.

Master-keyed in one group of 2400 locks, or less, all different.

- No. 1680, Case,  $5\frac{1}{2} \times 3\frac{1}{2} \times \frac{3}{4}$  inches. Reversible, . . . each, \$8.25  
 No. 1680 1/2, Case,  $6 \times 3\frac{1}{2} \times \frac{3}{4}$  " " Not Reversible, . . . " 8.75

Case—Japanned Iron.  
 Front, Bolts, Hub and Strike—Bronze.  
 Five Tumblers.  
 Backset,  $2\frac{3}{4}$  inches.



1670 1/2

### Hotel Knob Locks.

Master-keyed, in one group of 1920  
 Locks, or less, all different.

Case,  $6 \times 3\frac{1}{2} \times \frac{3}{4}$  inches—Japanned  
 Iron.

Front, Bolts, Hub and Strike—  
 Bronze. Three Tumblers.

Backset,  $2\frac{3}{4}$  inches. Not Reversible.

No. 1670 1/2, for Corridor Doors,  
 each, . . . . \$8.15

No. 1671 1/2, for Communicating  
 Doors, . . . . each, \$8.15



1690



Hotel  
Mortise Knob Lock.

Master-keyed, in one group of 4800 locks, or less, all different.

Case,  $6 \times 3\frac{1}{2} \times \frac{7}{8}$  inches—Japanned Iron.

Front, Bolts, Hub and Strike—Bronze.

Backset,  $2\frac{3}{4}$  inches.

Five Tumblers.

Not Reversible—Specify Hand when ordering.

No. 1690, . . . each, \$7.85



1685



Hotel  
Mortise Knob Lock.

Master-keyed, in one group of 43680 locks, or less, all different.

Case,  $6\frac{3}{8} \times 3\frac{5}{8} \times \frac{3}{4}$  ins.—Japanned Iron.

Front, Bolts, Hub and Strike—Bronze.

Backset,  $2\frac{3}{4}$  inches.

Three Tumblers.

Not Reversible—Specify Hand when ordering.

No. 1685, . . . each, \$12.00





### Hotel Mortise Knob Locks.

Master-keyed, in one group of 360 locks, or less, all different.

Case,  $6 \times 3\frac{1}{2} \times \frac{7}{8}$  inches—Japanese Iron.

Front, Bolts, Hub and Strike—Bronze.

Four Tumblers.

Backset,  $2\frac{3}{4}$  inches.

Reversible—For Doors of either Hand.

- No. 1695, Operated : Latch Bolt by Knob from either side.  
Dead Bolt from *outside* by Change and Master-key;  
from *inside* by Thumb-piece only, . . . . . each, \$11.00
- No. 1696, Operated : Latch Bolt by Knobs from either side.  
Dead Bolt from *outside* by Change and Master-key,  
except when locked from inside ; from *inside* by  
Thumb-piece only, . . . . . " 11.00
- No. 1697, Operated : Latch Bolt by Knobs from either side.  
Dead Bolt from *outside* by Change key at all times  
and by Master-key except when locked from inside ;  
from *inside* by Thumb-piece only, . . . . . " 11.00
- No. 1698, Operated : Latch Bolt by Knob from either side.  
Dead Bolt from *outside* by Master-key at all times,  
and by Change key except when locked from in-  
side ; from *inside* by Thumb-piece only, . . . . . " 11.00
- No. 1699, Operated : Latch Bolt by Knob from either side.  
Dead Bolt by Change and Master-key from *either*  
side, . . . . . " 11.00

See Note as to Method of Pricing, page 33. Cuts  $\frac{1}{4}$  Size.

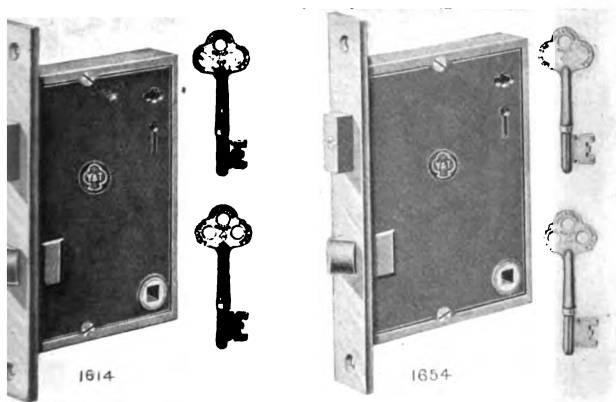

### Mortise Office Locks.

Master-keyed in one group of 1920 locks, or less, all different.

1614, Case,  $6 \times 3\frac{1}{2} \times \frac{3}{4}$  inches. Backset,  $2\frac{3}{4}$  inches, each, \$8.80

1654, Case,  $6 \times 4\frac{1}{4} \times \frac{3}{4}$  inches. Backset,  $3\frac{5}{8}$  inches, " 8.80

—Japanned Iron. Front, Bolts, Hub and Strike—Bronze. Reversible—  
For Doors of either Hand.



### Yale Office Locks.

Case, size as below—Japanned Iron.

Front, Bolts, Cylinder, Hub and  
Strike—Bronze.

Backset, as below.

Reversible—For Doors of either  
Hand.

No. 614, Case,  $5\frac{1}{2} \times 3\frac{3}{8} \times 1$  ins.  
Backset,  $2\frac{1}{4}$  inches, each, \$15.80

No. 654, Case,  $5\frac{1}{2} \times 3\frac{3}{8} \times 1$  ins.  
Backset,  $2\frac{3}{4}$  inches, each, \$15.80

See Note as to Method of Pricing, page 33. Cuts  $\frac{1}{4}$  Size.



656

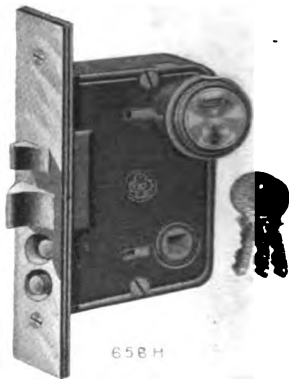

656H

### Yale Office Latches.

Automatically dead-locked, when door is closed, by means of an auxiliary bolt, which makes it impossible to retract the bolt by inserting any instrument which will exert a pressure against the bolt.

No. 656, Easy Spring Latch Bolt. Reversible, . . . . . each, \$15.00

No. 656H, Hinged Latch Bolt. Not Reversible, . . . . . " 15.65

Case,  $5 \times 3\frac{5}{8} \times \frac{3}{4}$  inches—Japanned Iron. Backset,  $2\frac{3}{4}$  inches. Front Bolts, Cylinder, Hub and Strike—Bronze.



660

### Yale Office Lock.

Case,  $4\frac{1}{2} \times 3\frac{5}{8} \times \frac{3}{4}$  inches — Japanned Iron.

Front, Bolts, Cylinder, Hub and Strike—Bronze.

Backset,  $2\frac{3}{4}$  inches.

Reversible—For Doors of either Hand.

No. 660, . . . . . each, \$12.65

See Note as to Method of Pricing, page 33. Cuts  $\frac{1}{4}$  Size.

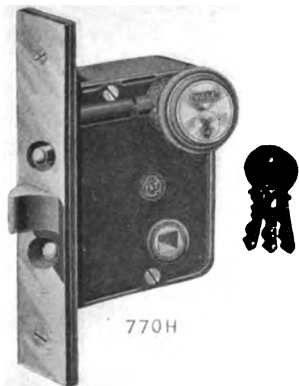
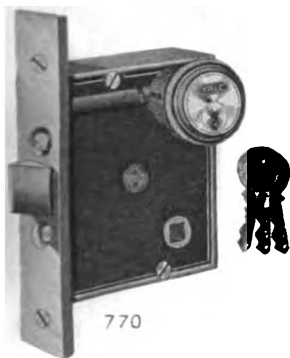

Yale Office Latches.

No. 770, Easy Spring Latch Bolt, . . . . . each, \$12.15  
 No. 770H, Hinged Latch Bolt, . . . . . , " 12.80  
 Case,  $4\frac{5}{8} \times 3\frac{3}{4} \times \frac{7}{8}$  inches—Japanned Iron. Front, Bolts, Cylinder, Hub and Strike—Bronze. Backset,  $2\frac{3}{4}$  inches. Not Reversible—Specify Hand when ordering.

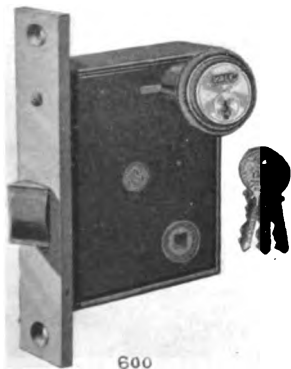

Yale Office Latch.

Case,  $5\frac{1}{8} \times 3\frac{5}{8} \times \frac{7}{8}$  inches—Japanned Iron.  
 Front, Bolts, Cylinder, Hub and Strike—Bronze.  
 Backset,  $2\frac{3}{4}$  inches.  
 Reversible—For Doors of either Hand.  
 No. 600, . . . . . each, \$12.15

See Note as to Method of Pricing, page 33. Cuts  $\frac{1}{4}$  Size.

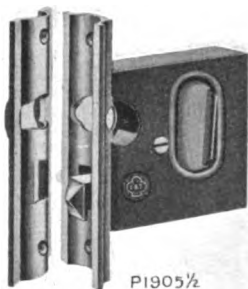

P1905 1/2



P1902 1/2

### Flush Pull Sliding Door Latches.

- No. P1902 1/2, Flat Front, for Single Doors. Case, 3 1/4 x 3 1/4 x 5/8 inches. Backset, 2 inches, . . . . . each, \$2.20
- No. P1904 1/2, Flat Front, for Double Doors. Case, 3 1/4 x 3 1/4 x 5/8 inches. Backset, 2 inches, " 2.40
- No. P1905 1/2, Astragal Front, for Double Doors. Case, 3 1/4 x 3 1/4 x 5/8 inches. Backset, 2 1/4 inches, " 2.80
- Case—Japanned Iron. Front, Bolt and Strike—Bronze. Reversible—For Doors of either Hand.



1792



### Elevator

#### Sliding Door Locking Latch.

- Case, 5 1/8 x 2 3/4 x 7/8 inches—Buffed Bronze.
- Bolt and Strike—Buffed Bronze.
- Backset, 1 1/4 inches.
- Reversible—For Doors of either Hand.
- No. 1792, . . . . . each, \$4.70

See Note as to Method of Pricing, page 33. Cuts 1/4 Size.

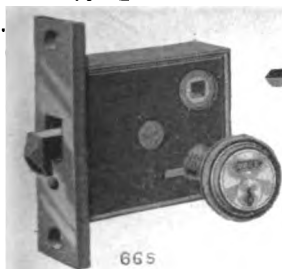

66S



344S

**Yale Mortise Sliding Door Locks.**

No. 66S, Night Latch. Case,  $3\frac{1}{4} \times 3\frac{1}{2} \times \frac{3}{4}$  inches, . . each, \$11.20

No. 344S, Dead Lock. "  $2\frac{3}{8} \times 3\frac{5}{8} \times \frac{3}{4}$  " . . " 10.60

Case—Japanned Iron. Front, Bolt, Cylinder and Strike—Bronze.

Backset,  $2\frac{3}{4}$  inches. Reversible—For Doors of either Hand.



304S

**Yale**

**Sliding Door Dead Lock.**

Case,  $4\frac{3}{8} \times 3\frac{5}{8} \times 1\frac{1}{8}$  ins.—  
Japanned Iron.

Front, Bolts, Cylinder and  
Strike—Bronze.

Backset,  $2\frac{3}{4}$  inches.

Reversible—For Doors of either  
Hand.

No. 304S, . . each, \$22.00

See Note as to Method of Pricing, page 33. Cuts  $\frac{1}{4}$  Size.

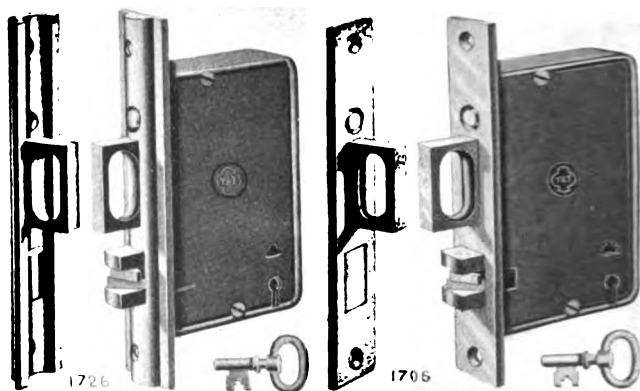

### Mortise Sliding Door Locks.

- No. 1706, Flat Front, for Double Doors. Backset,  $2\frac{3}{4}$  inches\*, each, \$ 8.40  
 No. 1706½, " " Single " " " " " " 6.20  
 No. 1726, Astragal Front, for Double Doors. "  $2\frac{7}{8}$  " " " 10.50  
 Case,  $5\frac{1}{2} \times 3\frac{1}{2} \times \frac{3}{4}$  inches—Japanned Iron. Front, Bolt, Strike and Pull  
 —Bronze. Three Tumblers. Reversible—For Doors of either Hand.



### Mortise Sliding Door Locks.

- Case,  $5\frac{1}{4} \times 3\frac{3}{8} \times \frac{5}{8}$  inches—  
 Japanned Iron.  
 Front, Bolt, Strike and Pull—Bronze.  
 Regular Backset,  $2\frac{3}{4}$  inches.\*  
 Reversible—For Doors of either Hand.  
 No. P3912½, Flat Front for  
 Single Doors, . . each, \$2.55  
 No. P3924½, Flat Front for  
 Double Doors, . . each, 3.45  
 No. P3936½, Astragal Front  
 for Double Doors, . each, 4.75  
 \*Other Backsets made to Special  
 Order.

See Note as to Method of Pricing, page 33. Cuts  $\frac{1}{4}$  Size.

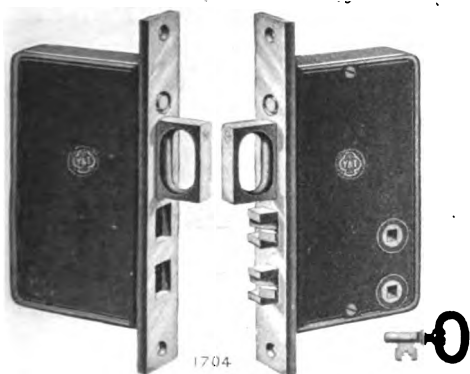

Mortise Sliding Door Locks.

No. 1704, Flat Front for Double Doors, . . . . . each, \$37.25  
 No. 1704½, " " Single " . . . . . " 28.50  
 Case, 6<sup>3</sup>/<sub>8</sub> × 3½ × ¾ inches—Japanned Iron. Front, Bolt, Strike, Hubs  
 and Pull—Bronze. Regular Backset, 2¾ inches.\* Reversible.

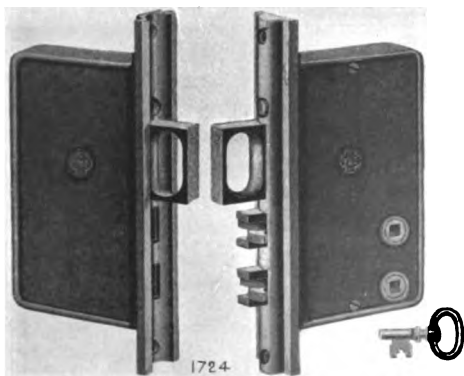

Mortise Sliding Door Locks.

No. 1724, Same as No. 1704, but with Astragal Front, . . . each, \$49.50  
 Regular Backset, 2¾ inches.\* Reversible.  
 \* Other Backsets made to Special Order.

See Note as to Method of Pricing, page 331. Cut. ¼ Size.



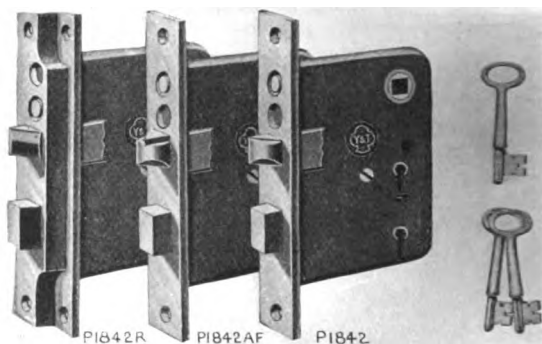

### Mortise Front Door Locks.

Case,  $4\frac{3}{4} \times 3\frac{5}{8} \times \frac{5}{8}$  inches—Japanned Iron. Front Bolts and Strike—Bronze.

Reversible—For Doors of either Hand. Backset,  $2\frac{3}{4}$  inches

- |  |  |              |
|--|--|--------------|
| No. P1842, Flat Front, Easy Spring Latch Bolt.     | Tumblers,                                    |              |
|  | 1 on Dead Bolt, 1 on Latch Bolt, . . .       | each, \$3.10 |
| No. P1843, Flat Front Easy Spring Latch Bolt.      | Tumblers,                                    |              |
|  | 1 on Dead Bolt, 3 on Latch Bolt, . . .       | " 3.45       |
| No. P1842AF, Flat Front, Anti-Friction Latch Bolt. | Tumb-  |              |
|  | lers, 1 on Dead Bolt, 1 on Latch Bolt, . . . | " 4.00       |
| No. P1843AF, Flat Front, Anti-Friction Latch Bolt. | Tumb-  |              |
|  | lers, 1 on Dead Bolt, 3 on Latch Bolt, . . . | " 4.35       |

Not Reversible—Specify Hand when ordering. Backset,  $2\frac{1}{4}$  inches.

- |   |  |            |
|---|--|------------|
| No. P1842R, Rabbeted Front, Easy Spring Latch Bolt. | Tumb-  |            |
|   | lers, 1 on Dead Bolt, 1 on Latch Bolt, . . . | each, 6.00 |
| No. P1843R, Rabbeted Front, Easy Spring Latch Bolt. | Tumb-  |            |
|   | lers, 1 on Dead Bolt, 3 on Latch Bolt, . . . | " 6.65     |

See Note as to Method of Pricing, page 33. Cuts  $\frac{1}{4}$  Size.

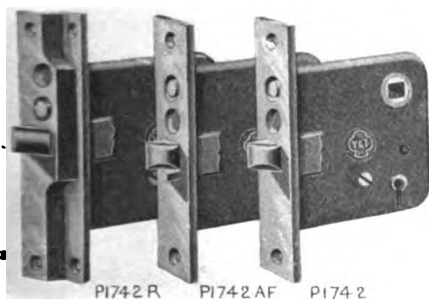

Mortise Vestibule Latches.

Case,  $3\frac{1}{4} \times 3\frac{3}{4} \times \frac{5}{8}$  inches—Japanned Iron. Front, Bolts and Strike—Bronze.

Reversible—For Doors of either Hand. Backset,  $2\frac{3}{4}$  inches.

No. P1742, Flat Front, Easy Spring Latch Bolt, 1 Tumbler,	each,	\$2.65
No. P1743, " " " " " " 3 " "		3.00
No. P1742AF, Flat Front, Anti-Friction Latch Bolt, 1 Tumbler,		3.55
No. P1743AF, Flat Front, Anti-Friction Latch Bolt, 3 Tumblers,		3.90

Not Reversible—Specify Hand when ordering. Backset,  $2\frac{1}{4}$  inches.

No. P1742R, Rabbeted Front, Easy Spring Latch Bolt, 1 Tumbler,	each,	5.55
No. P1743R, Rabbeted Front, Easy Spring Latch Bolt, 3 Tumblers,		5.90

See Note as to Method of Pricing, page 33. Cuts  $\frac{1}{4}$  Size.



P3510



Vulcan Jr.  
Front Door Locks.

Wrought Metal.

Case,  $5 \times 3\frac{3}{8} \times 1\frac{9}{16}$  inches—Bronze  
Plated Steel.

Front, Bolts, Hub and Strike—  
Bronze.

Backset,  $2\frac{3}{4}$  inches.

Reversible—For Doors of either  
Hand.

No. P3510,	Tumblers,	1	on	Dead Bolt,	1	on	Latch Bolt,	each,	\$3.65
No. P3530,	"	1	"	"	3	"	"	"	4.00
No. P3533,	"	3	"	"	3	"	"	"	4.35



P3510 1/2



Vulcan Jr.

Vestibule Latches.

Wrought Metal.

Case,  $5 \times 3\frac{3}{8} \times 1\frac{9}{16}$  inches—Bronze  
Plated Steel.

Front, Bolt, Hub and Strike—Bronze.

Backset,  $2\frac{3}{4}$  inches.

Reversible—For Doors of either Hand.

No. P3510 1/2,	1	Tumbler,	each,	\$3.30
No. P3530 1/2,	3	"	"	3.65

See Note as to Method of Pricing, page 33. Cuts 1/4 Size.

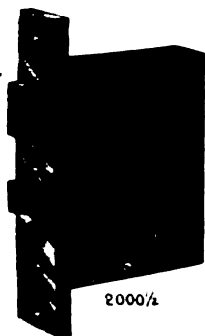

2000 1/2



Mortise  
Front Door Lock.

Master-keyed, in one group of 400 Locks, or less, all different.

Case,  $5\frac{1}{2} \times 3\frac{3}{4} \times \frac{3}{4}$  inches—Japanned Iron.

Front, Bolts, Hub and Strike—Bronze.

Backset,  $2\frac{3}{4}$  inches.

Not Reversible—Specify Hand when ordering.

No. 2000 1/2, 4 Tumblers, . . . . . each, \$9.90

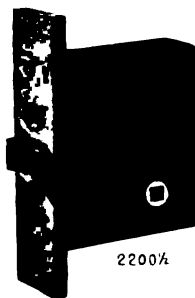

2200 1/2



Mortise  
Vestibule Latch.

Master-keyed, in one group of 400 Locks, or less, all different.

Case,  $4\frac{5}{8} \times 3\frac{3}{4} \times \frac{3}{4}$  inches—Japanned Iron.

Front, Bolt, Hub and Strike—Bronze.

Backset,  $2\frac{3}{4}$  inches.

Not Reversible—Specify Hand when ordering.

No. 2200 1/2, 4 Tumblers, . . . . . each, \$7.70

See Note as to Method of Pricing, page 33. Cuts 1/4 Size.

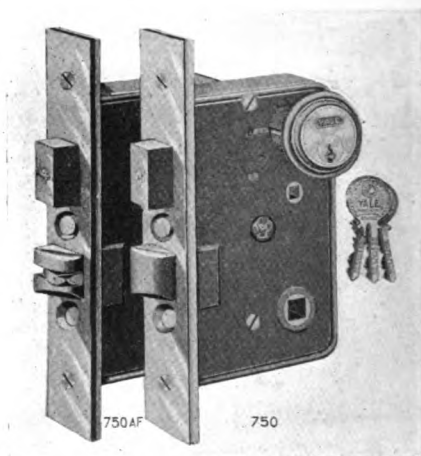

No. 750, Flat Front, Easy Spring Latch Bolt, . . . . . each, \$14  
 No. 750AF, Flat Front, Anti-Friction Latch Bolt, . . . . . " 14

### Yale Front Door Lock

Case,  $6 \times 3\frac{3}{4} \times \frac{3}{4}$  in.  
—Japanned Iron.

Front, Bolts, Hub,  
inder and Strik  
Bronze.

Backset,  $2\frac{3}{4}$  inches.

Reversible—For Door  
either Hand.

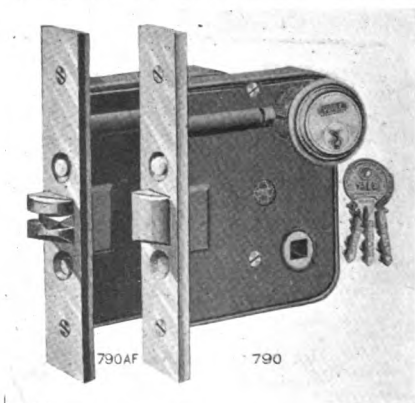

No. 790, Flat Front, Easy Spring Latch Bolt, . . . . . each, \$11  
 No. 790AF, Flat Front, Anti-Friction Latch Bolt, . . . . . " 11

### Yale Vestibule Latch

Case,  $5 \times 3\frac{3}{4} \times \frac{3}{4}$   
—Japanned Iron.

Front, Bolt, Hub,  
inder and Strik  
Bronze.

Backset,  $2\frac{3}{4}$  inches.

Reversible—For Door  
either Hand.

See Note as to Method of Pricing, page 33. Cuts  $\frac{1}{4}$  Size.

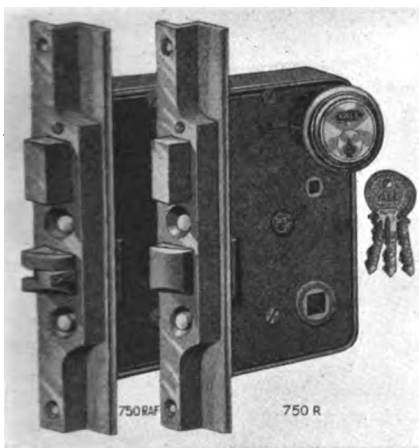

**Yale  
Front Door Locks.**

**Rabbeted Front.**

Case,  $6 \times 3\frac{3}{4} \times \frac{3}{4}$  ins.  
—Japanned Iron

Front, Bolts, Hub, Cylinder and Strike—  
Bronze.

Backset,  $2\frac{3}{4}$  inches.

Not Reversible—Specify Hand when ordering.

No. 750R, Rabbeted Front, Easy Spring Latch Bolt, . . . each, \$18.50  
No. 750RAF, Rabbeted Front, Anti-Friction Latch Bolt, . . . “ 18.50

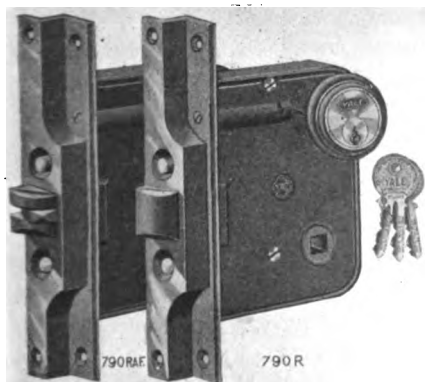

**Yale  
Vestibule Latches.**

**Rabbeted Front.**

Case,  $5 \times 3\frac{3}{4} \times \frac{3}{4}$  ins.  
—Japanned Iron.

Front, Bolt, Hub, Cylinder and Strike—  
Bronze.

Backset,  $2\frac{3}{4}$  inches.

Not Reversible—Specify Hand when ordering.

No. 790R, Rabbeted Front, Easy Spring Latch Bolt, . . . each, \$15.00  
No. 790RAF, Rabbeted Front, Anti-Friction Latch Bolt, . . . “ 15.00

See Note as to Method of Pricing, page 33. Cuts  $\frac{1}{4}$  Size.

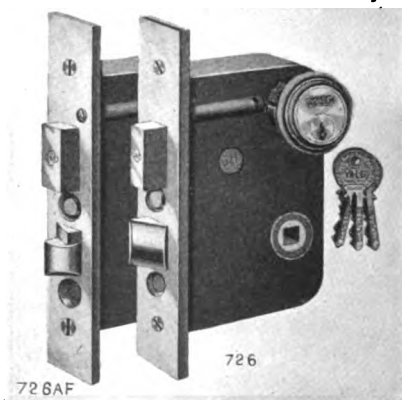

## Yale

## Front Door Locks.

Case,  $5\frac{3}{8} \times 3\frac{3}{8} \times \frac{7}{8}$  ins.  
—Japanned Iron.

Front, Bolts, Strike, Hub  
and Cylinder—Bronze.

Regular Backset,  $2\frac{3}{4}$   
inches.\*

Not Reversible—Specify  
Hand when ordering.

No. 726, Flat Front, Easy Spring Latch Bolt, . . . . each, \$14.50  
No. 726AF, " " Anti-Friction Latch Bolt, . . . . " 14.50

\*Made to order with Special Backsets from  $1\frac{3}{4}$  to 5 inches.

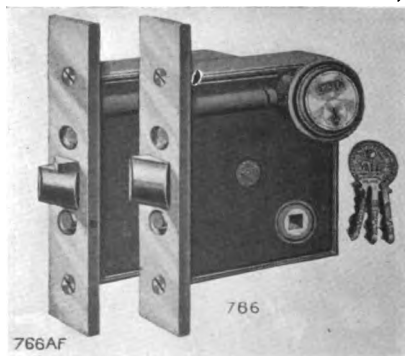

## Yale

## Vestibule Latches.

Case,  $4\frac{5}{8} \times 3\frac{3}{4} \times \frac{7}{8}$  ins.  
—Japanned Iron.

Front, Bolt, Strike, Hub  
and Cylinder—Bronze.

Regular Backset,  $2\frac{3}{4}$   
inches.\*

Not Reversible—Specify  
Hand when ordering.

No. 766, Flat Front, Easy Spring Latch Bolt, . . . . each, \$11.00  
No. 766AF, " " Anti-Friction Latch Bolt, . . . . " 11.00

\*Made to order with Special Backsets from  $1\frac{7}{8}$  to  $4\frac{3}{4}$  inches.

See Note as to Method of Pricing, page 33. Cuts  $\frac{1}{4}$  Size.

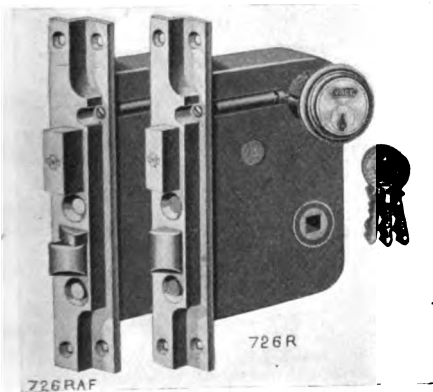

**Yale**  
**Front Door Locks.**

**Rabbeted Front.**

Case,  $5\frac{3}{8} \times 3\frac{5}{8} \times \frac{7}{8}$  ins.  
—Japanned Iron.

Front, Bolts, Hub, Cylinder and Strike—  
Bronze.

Regular Backset,  $2\frac{3}{4}$   
inches.\*

Not Reversible—Specify  
Hand when ordering.

No. 726R, Rabbeted Front, Easy Spring Latch Bolt, . each, \$18.50  
No. 726RAF, “ “ Anti-Friction “ “ . “ 18.50

\*Made to order with Special Backset from  $1\frac{3}{4}$  to 5 inches.

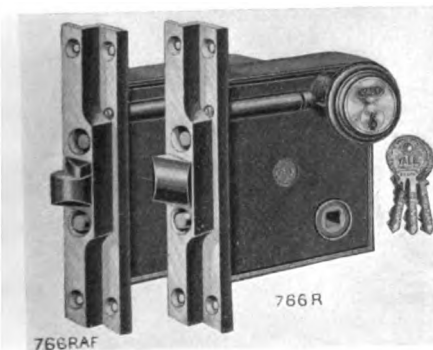

**Yale**  
**Vestibule Latches.**

**Rabbeted Front.**

Case,  $4\frac{5}{8} \times 3\frac{3}{4} \times \frac{7}{8}$  ins.  
—Japanned Iron.

Front, Bolt, Hub, Cylinder and Strike—  
Bronze.

Regular Backset,  $2\frac{3}{4}$   
inches.\*

Not Reversible—Specify  
Hand when ordering.

No. 766R, Rabbeted Front, Easy Spring Latch Bolt, . each, \$15.00  
No. 766RAF, “ “ Anti-Friction “ “ . “ 15.00

\*Made to order with Special Backsets from  $1\frac{7}{8}$  to  $4\frac{3}{4}$  inches.

See Note as to Method of Pricing, page 33. Cuts  $\frac{1}{4}$  Size.



## Yale

## Front Door Locks.

Case,  $7\frac{1}{2} \times 3\frac{3}{4} \times 1\frac{1}{8}$  ins.—Japanned Iron.

Front, Bolts, Hub, Cylinder and Strike—Bronze.

Backset,  $2\frac{3}{4}$  inches.\*

Not Reversible.

No. 234  $\frac{1}{2}$ , Flat Front, . each, \$22.40

No. 234  $\frac{1}{2}$  R, Rabbetted Front, each, \$26.40

\*Also furnished with  $4\frac{1}{2}$  and  $5\frac{1}{4}$  inch Backsets.

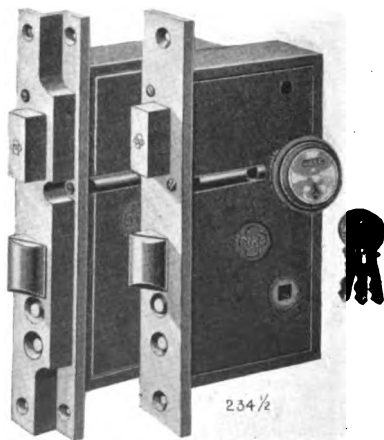
234  $\frac{1}{2}$ 234  $\frac{1}{2}$  R

## Yale

## Vestibule Latches.

Case,  $5\frac{5}{8} \times 3\frac{3}{4} \times 1\frac{1}{8}$  ins.—Japanned Iron.

Front, Bolt, Hub, Cylinder and Strike—Bronze.

Backset,  $2\frac{3}{4}$  inches.\*

Not Reversible.

No. 274  $\frac{1}{2}$ , Flat Front, each, \$13.20

No. 274  $\frac{1}{2}$  R, Rabbetted Front, each, \$17.20

\*Also furnished with  $4\frac{1}{2}$  and  $5\frac{1}{4}$  inch Backsets.

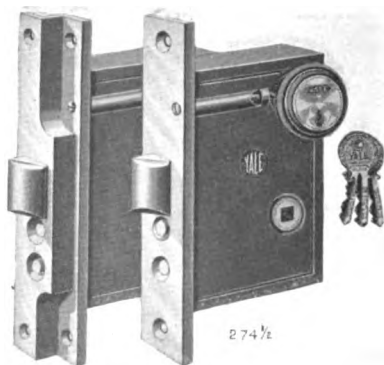
274  $\frac{1}{2}$ 274  $\frac{1}{2}$  R



**Yale  
Front Door Lock.**

Case,  $7\frac{1}{2} \times 4 \times 1$  inches—  
Japanned Iron.  
Front, Bolts, Hub, Cylinder and  
Strike—Bronze  
Backset, 3 inches.  
Not Reversible—Specify **H a n d**  
when ordering.  
No. 236  $\frac{1}{2}$ , . . . each, \$22.40

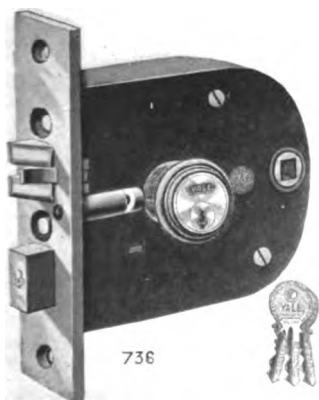

**Yale  
Front Door Lock.**

Case,  $4\frac{3}{8} \times 5\frac{3}{8} \times 7\frac{7}{8}$  inches—  
Japanned Iron.  
Front, Bolts, Hub, Cylinder and  
Strike—Bronze.  
Backset } Hub,  $4\frac{7}{8}$  inches.  
          } Cylinder,  $2\frac{3}{8}$  inches.  
Not Reversible—Specify **H a n d**  
when ordering.  
No. 736, Anti-Friction Latch  
Bolt, . . . . . each, \$18.50

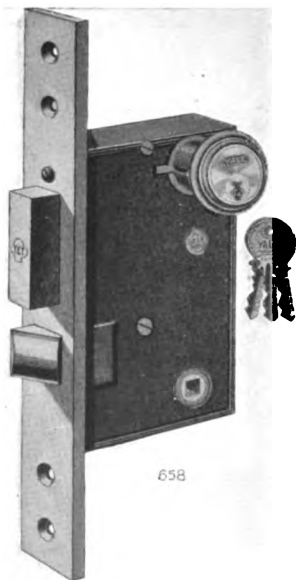

658

## Yale

## Front Door Lock.

For Heavy Entrance Doors.

Case,  $6\frac{1}{2} \times 4 \times 1$  inches—Japanned Iron.

Front, Bolts, Hub, Cylinders and Strike—Bronze.

Backset, 3 inches.

Not Reversible — Specify Hand when ordering.

No. 658, . . . each, \$39.60



244½S

## Yale Knob Lock.

For Stable Doors.

Case,  $5\frac{1}{2} \times 3\frac{3}{4} \times 1\frac{1}{8}$  inches—Japanned Iron.

Front, Bolts, Cylinders and Strike—Bronze.

Backset,  $2\frac{3}{4}$  inches.

Not Reversible — Specify Hand when ordering.

No. 244  $\frac{1}{2}$  S, . . . each, \$24.25See Note as to Method of Pricing, page 33. Cuts  $\frac{1}{4}$  Size.

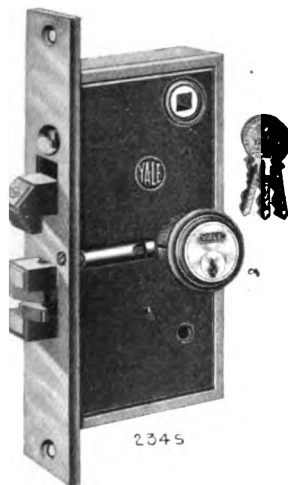

**Yale  
Front Door Lock.**

For Sliding Doors.\*

Case,  $7\frac{1}{2} \times 3\frac{3}{4} \times 1$  inches—  
Japanned Iron.

Front, Bolts, Hub, Cylinders and  
Strike—Bronze

Backset,  $2\frac{3}{4}$  inches.

Not Reversible — Specify Hand  
when ordering.

No. 234S, . . . each, \$33.00

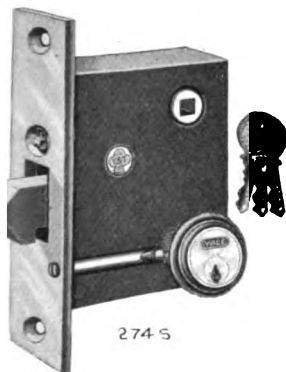

**Yale  
Vestibule Latch.**

For Sliding Doors.\*

Case,  $4\frac{3}{4} \times 3\frac{3}{4} \times 1\frac{1}{8}$  inches—  
Japanned Iron.

Front, Bolts, Hub, Cylinders and  
Strike—Bronze.

Backset,  $2\frac{3}{4}$  ins. Not Reversible.

No. 274S, . . . each, \$18.75

\*Illustration shows the lock as  
regularly furnished. It can be  
furnished "inverted" if desired  
(and so specified on order) with-  
out extra charge.

Also furnished with  $\frac{3}{4}$  inch flat or  
round Astragal Fronts at an ad-  
ditional price.

See Note as to Method of Pricing, page 33. Cuts  $\frac{1}{4}$  Size.

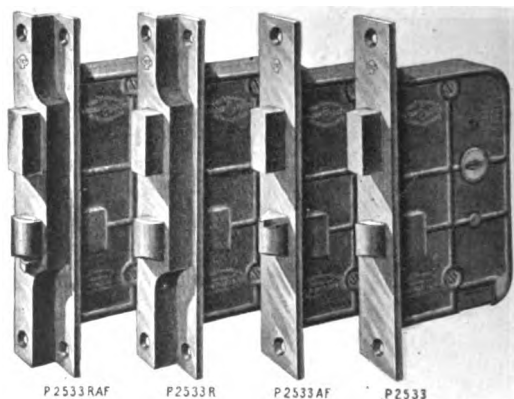

### Vulcan Mortise Store Door Locks.

Case,  $5 \times 3\frac{1}{8} \times \frac{5}{8}$  inches—Bronze Plated Steel. Front, Bolts and Strike—Bronze. Backset,  $2\frac{1}{8}$  inches. Three Tumblers.

No. P2533, Flat Front, Easy Spring Latch Bolt. Reversible, each, \$5.55

No. P2533AF, Flat Front, Anti-Friction Latch Bolt. Reversible, . . . . . " 6.20

No. P2533R, Rabbeted Front. Easy Spring Latch Bolt. Not Reversible, . . . . . " 8.20

No. P2533RAF, Rabbeted Front. Anti-Friction Latch Bolt. Not Reversible, . . . . . " 8.85



### Mortise Store Door Latch.

Case,  $3 \times 3 \times \frac{3}{4}$  inches—Japanned Iron.

Front, Bolt and Strike—Bronze.

Backset,  $2\frac{1}{4}$  inches.

Reversible—For Doors of either Hand.

No. 1122, . . . . . each, \$7.65

See Note as to Method of Pricing, page 33. Cuts  $\frac{1}{4}$  Size.

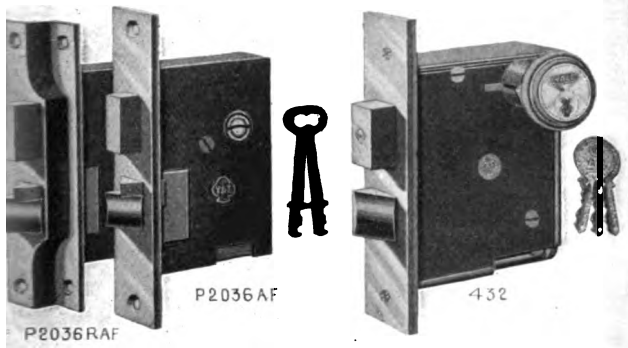

## Mortise Store Door Locks.

- Case, Size as below—Japanned Iron. Front, Bolts and Strike—Bronze.
- . P2036AF, Case,  $4\frac{1}{2} \times 3 \times \frac{3}{4}$  inches—Flat Front, Anti-Friction Latch Bolt. Backset, 2 ins. Reversible, each, \$ 5.55
  - . P2036RAF, Same as No. P2036AF, but with Rabbeted Front,  $1\frac{3}{8}$  inches Backset and Not Reversible, . “ 8.20
  - . 432, Case,  $5 \times 3\frac{3}{8} \times 1$  inches. Flat Front, Easy Spring Latch Bolt. Backset,  $2\frac{3}{4}$  ins. Reversible, “ 13.20
  - . 432R, Same as No. 432, but with Rabbeted Front, . “ 17.20
  - . 414, “ “ No. 432, but with  $2\frac{1}{4}$  ins. Backset, . “ 13.20
  - . 414R, “ “ No. 432R, “ “  $2\frac{1}{4}$  “ “ . “ 17.20



## Mortise Store Door Latches.

- Case,  $2\frac{3}{4} \times 2\frac{3}{4} \times \frac{5}{8}$  inches—Japanned Iron.  
Front, Bolt and Strike—Bronze.
- No. P2025, Flat Front,  $1\frac{1}{8}$  inches.  
Backset. Reversible, each, \$2.25
  - No. P2025R, Same as No. P2025,  
but with Rabbeted Front,  
 $1\frac{1}{8}$  inches Backset and  
Not Reversible, . . . “ 3.50

See Note as to Method of Pricing, page 33. Cuts  $\frac{1}{4}$  Size.

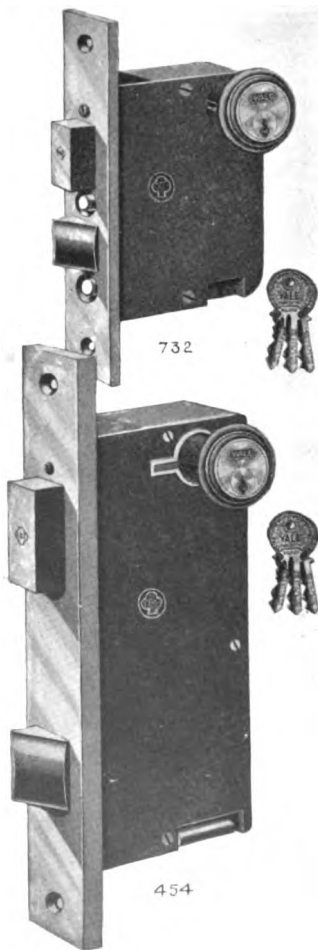

### Yale Store Door Locks.

Case,  $5\frac{1}{4} \times 3\frac{5}{8} \times 1$  inches—  
Japanned Iron.

Front, Bolts, Cylinders and  
Strike—Bronze.

Backset,  $2\frac{3}{4}$  inches.

Not Reversible—Specify Hand  
when ordering.

No. 732, Flat Front,  
each, . . . \$15.80

No. 732R, Rabbeted  
Front, . . . each, 19.80

### Yale Store Door Locks.

For Extra Heavy Doors.

Case,  $9\frac{1}{4} \times 3\frac{5}{8} \times 1\frac{1}{4}$  inches—  
Japanned Iron.

Front, Bolts, Cylinders and  
Strike—Bronze.

Backset,  $2\frac{3}{4}$  inches.

No. 454, Flat Front,  
Reversible, . each, \$46.20

No. 454R, Rabbeted  
Front, Not Reversi-  
ble, . . . each, 50.20

See Note as to Method of Pricing, page 33. Cuts  $\frac{1}{4}$  Size.

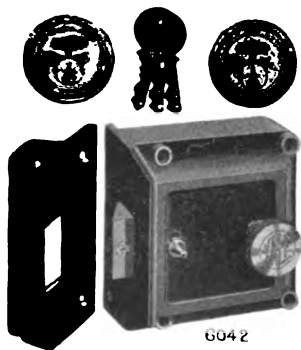

6042

Yale

Duplex Rim Night Latch.

Exclusively for Master-key systems, see page 123.

Case,  $4 \times 3\frac{5}{8}$  inches — Japanned Iron.

Strike—Japanned Iron.

Front, Bolt and Cylinders -- Bronze.

Backset,  $2\frac{3}{8}$  inches.

Reversible—For Doors of either Hand.

No. 6042, Operated by Change and Master-key from outside; by knob from inside, . . . . . each, \$11.00

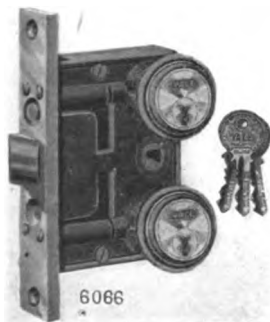

6066

Yale

Duplex Night Latches.

Exclusively for Master-key systems, see page 123.

Case,  $4\frac{3}{8} \times 3\frac{3}{8} \times \frac{3}{4}$  inches — Japanned Iron.

Front, Bolt, Cylinders and Strike—Bronze.

Backset,  $2\frac{3}{4}$  inches.

Reversible — For Doors of either Hand.

No. 6066, \* Style "A," Operated by both Change and Master-key from either side, (4 cylinders), . . . . . each, \$23.00

\* Also furnished in Style "B," operated by both keys from outside and by Change-key only from inside, (3 cylinders); Style "C," by both keys from outside, and Knob only from inside, (2 cylinders). Price given is for four cylinders. Deduction is made for cylinders not furnished.

See Note as to Method of Pricing, page 33. Cuts  $\frac{1}{4}$  Size,



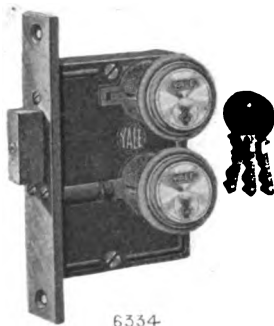

6334

Yale

## Duplex Dead Locks.

Exclusively for Master-key systems, see page 123.

Case,  $4\frac{3}{4} \times 3\frac{5}{8} \times \frac{3}{4}$  inches—Japanned Iron.

Front, Bolt, Cylinders and Strike—Bronze.

Backset,  $2\frac{3}{4}$  inches.

Reversible—For Doors of either Hand.

No. 6334,\* Style "A," Operated by both Change and Master-keys from either side (4 cylinders) . . . . . each, \$16.75



6346S

## Yale Duplex Latches.

For Sliding Doors.

Exclusively for Master-key systems, see page 123.

Case,  $4\frac{1}{2} \times 3\frac{5}{8} \times \frac{3}{4}$  inches—Japanned Iron.

Front, Bolt, Cylinders and Strike—Bronze.

Backset,  $2\frac{3}{4}$  inches.

Reversible—For Doors of either Hand.

No. 6346S,\* Style "A," Operated by both Change and Master-key from either side (4 cylinders), . . . . . each, \$26.40

\* Also furnished in Style "B," operated by both keys from outside, and by Change key only from inside (3 cylinders); Style "C," operated by both keys from outside only (2 cylinders). Price given is for four cylinders. Deduction is made for cylinders not furnished.

See Note as to Method of Pricing, page 33. Cuts  $\frac{1}{4}$  size.

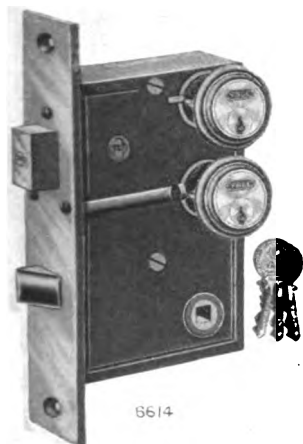

6614

**Yale  
Duplex Office Locks.**

Exclusively for Master-key systems,  
see page 123.

Case,  $6\frac{1}{2} \times 4 \times 1$  inches—Japanned  
Iron.

Front, Bolts, Hub, Cylinders and  
Strike—Bronze.

Backset, 3 ins. Not Reversible.

No. 6614, Operated by both  
Change and Master-key  
and by Knobs from either  
side, . . . each, \$26.40

No. 6615, Operated from  
outside by both Keys and  
Knob, from inside by  
Change-Key only and  
Knob, . . . each, \$24.20

No. 6616, Operated from  
outside by both Keys and  
Knob, from inside by  
Knob only, . . . each, \$22.00

**Yale  
Duplex Office Latches.**

Exclusively for Master-key systems,  
see page 123.

Case,  $6\frac{1}{8} \times 3\frac{3}{4} \times \frac{7}{8}$  inches—  
Japanned Iron.

Front, Bolt, Hub, Cylinders and  
Strike—Bronze.

Backset,  $2\frac{3}{4}$  ins. Not Reversible.

No. 6274, Operated by Knob  
from either side, and by  
Change and Master-key  
from outside only, each, \$17.60

No. 6270, Same as No.  
6274 but that Latch Bolt  
may be deadlocked from  
inside by Thumb-piece,  
each, . . . . . \$18.80

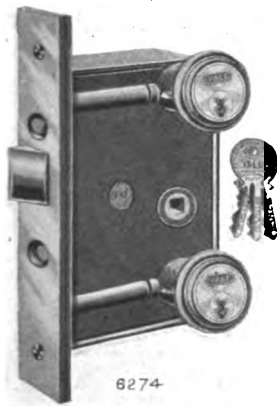

6274

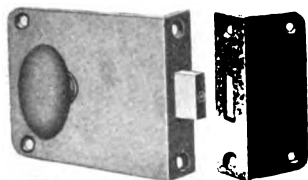

1780

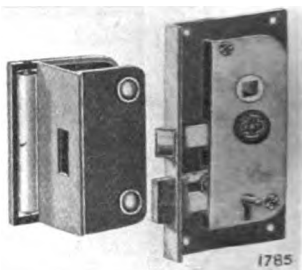

1785

### Flush Rim Locks.

Case, Size as below.—Bronze. Bolts, Knob and Strike—Bronze.

- No. 1780, Case,  $3 \times 3\frac{1}{2} \times \frac{5}{8}$  inches. Strike for wood (next to Case in above illustration). Reversible, . . . each, \$5.25
- No. 1780, with Strike for marble, (see illustration on right). Thickness of marble required to ascertain Depth, " 8.40
- No. 1785, Case,  $4\frac{1}{2} \times 2\frac{1}{4} \times \frac{3}{4}$  inches. Backset,  $1\frac{1}{4}$  inches.\* Two Tumblers. Not Reversible, . . . " 5.50
- \*Also furnished with  $1\frac{1}{2}$ ,  $1\frac{3}{4}$ , 2 and  $2\frac{1}{4}$  inch Backset at Additional Price.



1876

### Mortise Sliding Door Lock.

Guarded Bolt.

Case,  $5 \times 3\frac{7}{8} \times \frac{5}{8}$  inches—Bronze.

Front, Bolt, Hub and Strike—Bronze.

Backset,  $2\frac{1}{4}$  inches.

Reversible—For Doors of either Hand.

No. 1876, . . . each, \$12.60

See Note as to Method of Pricing, page 33. Cuts  $\frac{1}{4}$  Size.

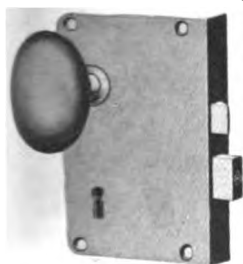

1720

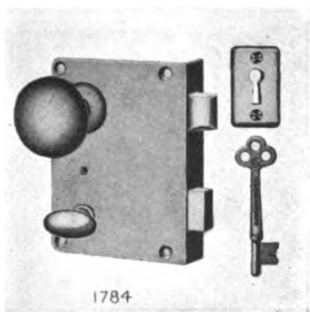

1784



Flush Rim Locks.

No. 1720, Case,  $5\frac{1}{4} \times 3\frac{1}{2}$  inches—Bronze, . . . each, \$9.90

No. 1784\*, "  $4\frac{3}{8} \times 3\frac{3}{8}$  " " " " " 8.00

Bolts, Knob, Hub and Strike—Bronze. Three Tumblers. Not Reversible  
—Specify Hand when ordering.

\*Master-keyed in one group of 8 Locks, or less, all different.

Style A, operated, Latch Bolt by Knob from inside, by Key from outside; Dead Bolt by Thumb-piece from inside; Style B, Latch Bolt by Knob from either side; Dead Bolt by Thumb-piece from inside only.

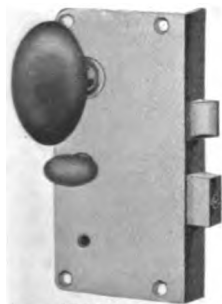

1782



Flush Rim Lock.

Master-keyed, in one group of 1920 Locks, or less, all different.

Case,  $6 \times 3\frac{1}{4}$  inches—Bronze

Bolts, Knobs, Hub, Strike and interior parts—Bronze.

Not Reversible—Specify Hand when ordering.

No. 1782, . . . each, \$17.60

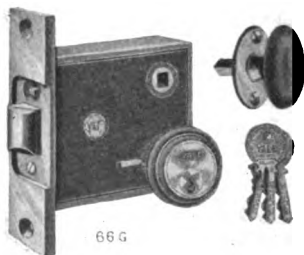

66G

### Yale Asylum Latches.

#### Guarded Latch Bolt.

Case,  $3\frac{1}{4} \times 3\frac{1}{2} \times \frac{3}{4}$  inches.

Front, Bolt, Cylinder, Hub and Strike—Bronze.

Backset,  $2\frac{3}{4}$  ins. Not Reversible.

No. 66G,\* Style "A" operated from one side by key, other side by knob, . . . each, \$9.70

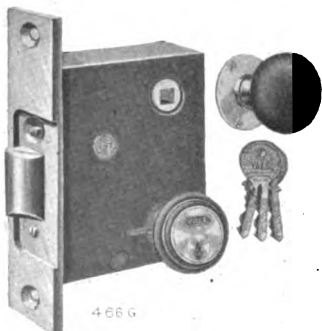

466G

### Yale Asylum Latches.

#### Guarded Latch Bolt.

Case,  $4\frac{3}{4} \times 3\frac{7}{8} \times 1$  inches.

Front, Bolt, Cylinder, Hub and Strike—Bronze.

Backset,  $2\frac{3}{4}$  ins. Not Reversible.

No. 466G,\* Style "A" operated from one side by key, other side by knob, . . . each, \$14.40

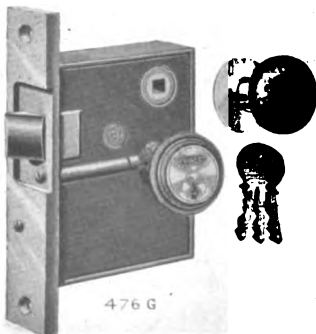

476G

### Yale Asylum Latch.

#### Guarded Deadlocking Latch Bolt.

Case,  $4\frac{7}{8} \times 3\frac{5}{8} \times \frac{3}{4}$  inches.

Front, Bolt, Cylinder, Hub and Strike—Bronze.

Backset,  $2\frac{3}{4}$  ins. Not Reversible.

No. 476G, . . . each, \$22.00

\*Also furnished in Style "B," operated from one side only by key. Deduction is made for knob not furnished. Furnished also at additional price, with two cylinders, operated by key from either side.



### Mortise Asylum Locks.

Dead-locking Bolt.

Master-keyed, in one group of 2400 locks, or less, all different.

Case,  $4\frac{5}{8} \times 3\frac{3}{4} \times \frac{3}{4}$  inches—Japanned Iron.

Front, Bolt, Hub and Strike—Bronze.

Backset,  $2\frac{3}{4}$  inches.

Three Tumblers.

Reversible— For Doors of either Hand.

No. 1508, with one key, each, \$6.15



### Mortise Asylum Latch.

Guarded Dead-locking Latch.

Master-keyed, in one group of 2400 locks, or less, all different.

Case,  $4\frac{5}{8} \times 3\frac{3}{4} \times \frac{3}{4}$  inches—Japanned Iron.

Front, Bolt, Hub and Strike—Bronze.

Backset,  $2\frac{3}{4}$  inches.

Three Tumblers.

Not Reversible—Specify Hand when ordering.

No. 1510, with one key, each, \$6.60



See Note as to Method of Pricing, page 33. Cuts  $\frac{1}{4}$  Size.

## Cabinet Locks.

For article on Cabinet Locks see Part II, Section 30, Page 216.

The following pages contain only a few selections from the extensive line of

The Yale & Towne Mfg. Co.

Chest Locks, . . . . .	page 677	Roller Top Desk Locks, page 67	
Cupboard Locks, . . . . .	" 674	Sub-Treasury Locks, . . . . .	" 67
Desk Locks, . . . . .	" 676	Wardrobe Locks, . . . . .	" 67
Drawer Locks, . . . . .	" 675	Ornamental Key Blanks, . . . . .	" 67
Locker Locks, . . . . .	" 675		



RA 272



## Sub-Treasury Locks.

Master-keyed, in one group of 210 locks, or less, all different.

Brass Plate. Iron Box and Bolt. 2 Secure Levers. Two Nickel Plated Flat Steel Keys to each lock, all different to the dozen.

Made for any thickness of door desired. Specify length of cylinder when ordering.  
No. RA272.  $1\frac{3}{4} \times 1\frac{1}{2}$  ins. Drop,  $\frac{7}{8}$  in. . . . . each, \$1.20

Also furnished with Iron Plate, Box and Bolt.



PA 74

## Cupboard Locks.

All Brass. Square Selvedge. Backset, or distance from Selvedge to Key Pin, as below. One fine Gold Plated Ornamental Cast Bronze Key with each lock. (For various styles of ornamental Bow see page 678.)

No.	Size, ins.	Backset	Each.	No.	Size, ins.	Backset	Each.
PA73,	$3\frac{1}{4} \times \frac{7}{8}$	$\frac{3}{8}$	\$1.35	PA77,	$3\frac{1}{4} \times 1\frac{1}{4}$	$\frac{7}{8}$	\$1.75
PA74,	" "	$\frac{1}{2}$	1.35	PA79,	$3\frac{1}{4} \times 1\frac{1}{2}$	$1\frac{1}{8}$	1.85
PA75,	$3\frac{1}{4} \times 1$	$\frac{5}{8}$	1.50	PA80,	$3\frac{1}{4} \times 1\frac{3}{4}$	$1\frac{1}{4}$	1.90
PA76,	" "	$\frac{3}{4}$	1.60	PA81,	$3\frac{1}{4} \times 1\frac{7}{8}$	$1\frac{1}{2}$	2.00

See Note as to Method of Pricing, page 33. Cuts  $\frac{1}{3}$  Size.

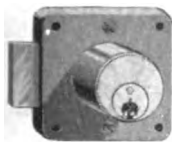

501



## Yale Cupboard Locks.

Master-keyed in one group of any desired number of locks, all different.

All Brass, Cylinder Buffed. Broad, heavy bolt. Diameter of cylinder,  $1\frac{1}{8}$  inches. Backset, 1 inch, 2 Paracentric Keys to each lock. Key changes unlimited.

b.	501	2	$\times 2$	inches,	For Wood,	$\frac{7}{8}$	inches,	each,	\$3.40
	505	"	"	"	"	"	$1\frac{1}{4}$	"	3.40
	507	"	"	"	"	"	$1\frac{1}{2}$	"	3.40

Also furnished with Nickel Plated Cylinders at additional price of 20 cents each. Also furnished with  $2 \times 1\frac{1}{2}$  inch case with dead or spring bolts as desired.

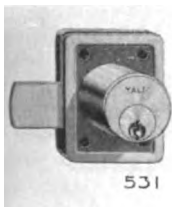

531



## Yale Locker Locks.

Master-keyed in one group of any desired number of locks, all different.

Cast Bronze Case. Wrought Bronze Cap and Bolt. Brass Cylinder, Buffed,  $1\frac{1}{8}$  inch diameter. Backset,  $\frac{3}{4}$  inch. 2 Paracentric Keys to each lock. Key changes unlimited.

c.	531	2	$\times 1\frac{1}{2}$	inch,	For Wood,	$\frac{3}{4}$	inch,	each,	\$2.90
	533	"	"	"	"	"	$\frac{7}{8}$	"	2.90

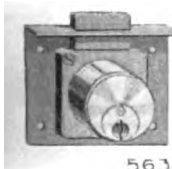

563



## Yale Drawer Locks.

Master-keyed in one group of any desired number of locks, all different.

All Brass, Cylinder Buffed. Broad, heavy bolt. Diameter of cylinder,  $1\frac{1}{8}$  inches. 2 Paracentric Keys to each lock. Key changes unlimited.

fo.	562	$1\frac{7}{8} \times 2\frac{1}{4}$	ins,	Drop,	1	in.,	For Wood,	$\frac{7}{8}$	in.,	† each,	\$2.75
	571	$2\frac{1}{2} \times 2\frac{1}{4}$	"	"	$1\frac{1}{2}$	"	"	"	$\frac{3}{4}$	"	2.70
	573	"	"	"	"	"	"	"	$\frac{7}{8}$	"	2.70

Also furnished with Nickel Plated Cylinder at an additional price of 30 cents each.

No. 563 also made with Spring Bolt, at additional price of 40 cents each.

Finished to special order for any thickness of wood desired.

See Note as to Methods of Pricing, page 33. Cuts  $\frac{1}{3}$  Size.



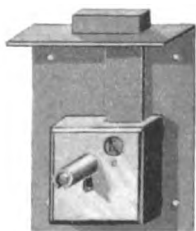

RA 180



No. RA180.  $1\frac{7}{8} \times 2\frac{1}{2}$  ins. Drop,  $\frac{7}{8}$  inch, . . . . . each, \$1.00  
 No. RA181. " " " " " " " " " " " 1.10

### Drawer Locks.

Master-keyed, in one group of 60 Locks, or less, all different. Brass Plate and Tube. Iron Box. Broad heavy Iron Bolt. 3 Secure Levers. One Malleable Iron Key with each lock, all different to the dozen. (For various styles of ornamental Bow, see page 678).



RA 310



No. R310.  $1\frac{3}{4} \times 2\frac{1}{4}$  ins. Iron Box and *Dead Bolt*, . . . each, \$1.50  
 No. RA390. " " Brass Box and Strike. Bronze  
*Latch Bolt*, . . . . . each, \$2.00

### Drawer Locks.

Master-keyed in one group of 210 locks, or less, all different. Brass Plate. Drop,  $\frac{7}{8}$  inch. 3 Secure Levers. For  $\frac{7}{8}$  in. Wood. Two Nickel Plated Flat Steel Keys with each lock, all different to the dozen.



S 230



No. S230.  $1\frac{1}{2} \times 3\frac{1}{2}$  ins. Drop,  $\frac{7}{8}$  inch, . . . . . each, \$3.00  
 Also furnished with Plain Wrought Brass Escutcheons, Buffed, Gold or Nickel Plated.

### Desk Locks.

Master-keyed, in one group of 60 locks, or less, all different. Solid Square Iron Box. Brass Selvedge. Iron Bolt, with Solid Brass Hooks. Brass strike, self-locking. Gold Plated Ornamental Cast Bronze Escutcheon. Two Nickel Plated Flat Steel Keys with each lock, all different to the dozen.

See Note as to Method of Pricing, page 33. Cuts  $\frac{1}{3}$  Size.



WA 102



## Wardrobe Locks.

Master-keyed, No. WA102, in one group of 1,200, and No. WA103 in one group of 200 locks, or less, all different.

All Brass. 2 Secure Levers. Bolt shoots right or left. Two Nickel Plated Flat Steel Keys with each lock, all different to the dozen.

No. WA102.  $2\frac{3}{4} \times 1\frac{1}{4}$  ins. For  $\frac{7}{8}$ , 1,  $1\frac{1}{8}$  in. Wood each, \$1.80  
 No. WA103.  $3 \times 1\frac{3}{4}$  " " " " " " " 2.00

Also furnished with Iron Plate and Box, Brass Bolt.



WA 120



## Wardrobe Locks.

Master-keyed, in one group of 3,000 locks, or less, all different.

All Brass. 5 Secure Levers. Bolt shoots right or left. Two Nickel Plated Flat Steel Keys with each lock, all different to the dozen.

No. WA120.  $2 \times 1\frac{5}{8}$  ins. For Wood,  $\frac{7}{8}$  in. each, \$3.30  
 Also furnished with Iron Plate and Box, Brass Bolt.



SA 154



## Chest Locks.

Master-keyed, No. SA154, in one group of 60 locks, or less, all different. All Brass. 3 Secure Levers. Two Nickel Plated Flat Steel Keys to each lock, all different to the dozen.

No.	Size.	For Wood.	Drop.	Each.
SA151.	$1\frac{1}{4} \times 1\frac{3}{4}$ ins.	$\frac{3}{4}$ in.	$\frac{3}{4}$ in.	\$1.60
SA152.	$1\frac{1}{2} \times 2$ "	"	$\frac{7}{8}$ "	2.00
SA153.	$1\frac{5}{8} \times 2\frac{1}{4}$ "	"	" "	2.30
SA154.	$1\frac{3}{4} \times 2\frac{1}{2}$ "	$\frac{3}{4}$ , 1, $1\frac{1}{4}$ in.	1 "	2.70

See Note as to Method of Pricing, page 33. Cuts  $\frac{1}{3}$  Size.

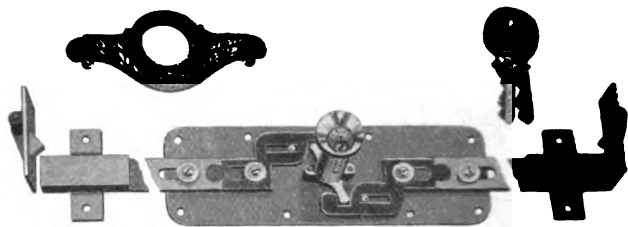

S 250

### Yale Pasquil Self-locking Roller Top Desk Lock.

Gold Plated Brass Cylinder and Strikes. Gold Plated Ornamental Cast Bronze Escutcheons. Brass Guides. Iron Plates and Rods. Rods adjusted to any size desk. For  $1\frac{1}{8}$ ,  $1\frac{1}{4}$  or  $1\frac{1}{2}$  inch wood. Two Paracentric Key with each lock. In specifying give length and thickness of curtain rail.

No. S250,  $5\frac{3}{4} \times 1\frac{7}{8}$  inches. Drop,  $\frac{7}{8}$  inch, . . . . . each, \$6 95



WA 50



P 625



RA 715



RA 724



RA 734



RA 754



RA 754



RA 773



RA 785



RA 793



RA 804



RA 814



RA 824



RA 900

### Ornamental Bronze Key Blanks.

For association with certain types of Drawer, Cupboard or Wardrobe Locks.

**Part V.**



**Locks in Sets.**

## Part V.

### Locks in Sets.

Section.	Pages.
1. TYPICAL LOCK-SETS WITH PLAIN TRIM.	
W7,000 series, Wrought metal, reversed, round corners and round edges, . . . . .	682-709
7,000 series, Cast metal, round corners and round edges, . . . . .	682-709
W6,000 series, Wrought metal, solid rolled, square corners and beveled edges, . . . . .	682-709
6,000 series, Cast metal, square corners and beveled edges, . . . . .	682-709
2. TYPICAL LOCK-SETS WITH ORNAMENTAL TRIM.	
Cluny design, . . . . .	710-735
Other designs, Part III, Section 3, . . . . .	236-612
3. STORE DOOR LOCK-SETS COMPLETE.	
Plain Trim, . . . . .	702, 738-743
Ornamental Trim, . . . . .	730, 744-760
4. TYPICAL LOCK-SETS WITH GLASS KNOBS.	
Ornamental Plates, . . . . .	736
Roses and Key Plates, . . . . .	737

The Catalogue Numbers in this Part are those of the Yale & Towne  
Manufacturing Company.

## Typical Lock-sets.

THE following pages contain illustrations of typical lock-sets including all the types of locks most commonly used. Many other Locks, designed to meet special conditions are illustrated and described in Part IV, pages 613 to 8.

As explained in Part II, Section 13, (page 161) a "lock-set" consists of a lock and its necessary trim. Various combinations of locks and trim are shown in the accompanying illustrations, opposite each of which is a specification of the component parts included in the Set and the price. Any other combinations desired can be made in like manner by selecting the proper Lock in Part IV (pages 613 to 678) and the appropriate

Ornamental Trim for it in Part III (pages 236 to 612) or in Part V (pages 704 and 709).

Prices of the lock-sets, and also of the locks and trim separate, are here given; but to give prices for each of the great number of possible combinations of locks and trim would exceed the scope and purpose of this volume. This information, however, can readily be obtained by combining the prices for locks given in Part IV and the prices for trim given in Parts III and V, the selection of the proper trim being based on the specification given herewith opposite the illustration of each lock-set.

### INDEX OF LOCK-SETS.

For	With Plain Trim.	With Orna. Trim.
Front Doors, . . . . .	pages 683	711
Vestibule Doors, . . . . .	" 685	713
Corridor, Room & Closet Doors	" 687	715
Communicating Doors, . . . . .	" 695	723
Sliding Doors, . . . . .	" 697	725
Hotel Doors, . . . . .	" 699	727
Office Doors, . . . . .	" 701	729
Store Door Doors, . . . . .	" 702	730

*See Note as to Method of Pricing, page 33.*

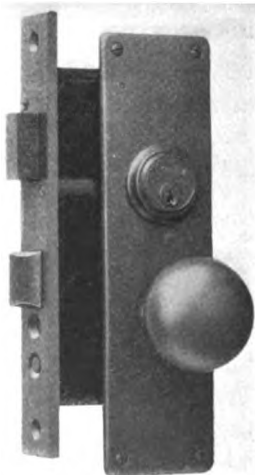

234½ LOCK



750 LOCK

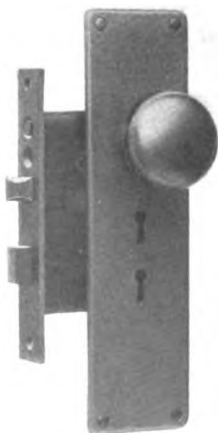

P1842 LOCK



P3510 LOCK

Lock-sets for Front Doors.  
Cuts in ¼ Size.

## Lock-sets for Front Doors.

TRIM : No. W7000 Series.

Wrought Bronze Buffed (BZ10) or (AZ10).\*

Illustrated on opposite page.

234½ Lock (p. 660); Trim: pair No. W55½ Knobs (p. 708)  
and two Escutcheon Plates, 10 × 2¾ inches (p. 705)  
Prices: Lock 234½, \$22.40. Trim, \$5.50. . . Set, \$27.90

750 Lock (p. 656); Trim: pair No. W55½ Knobs (p. 708)  
and two Escutcheon Plates; Outside 10 × 2¾ inches,  
Inside 7½ × 2¼ inches (p. 705).  
Prices: Lock 750, \$14.50. Trim, \$5.60. . . . Set, \$20.10

P3510 Lock (p. 654); Trim: pair No. W56 Knobs (p. 708)  
and two Escutcheon Plates, Outside 10 × 2¾ inches,  
Inside 1¾ × 1 inch (p. 705) and one Rose.  
Prices: Lock P3510, \$3.65. Trim, \$3.85. . . . Set, \$7.50  
Add for 3 Tumbler lock P3533 (p. 654) 70 cents.

P1842 Lock (p. 652); Trim: pair No. W56 Knobs (p. 708)  
and two Escutcheon Plates, Outside 10 × 2¾ inches,  
Inside 1¾ × 1 inch (p. 705), and one Rose.  
Price: Lock P1842, \$3.10. Trim, \$3.85. . . . Set, \$6.95  
Add for 3 Tumbler lock P1843 (p. 652), 35 cents.

## Above Locks (in sets) with Various Styles of Plain Trim.†

No.	W7000	7000	W6000	6000
234½ . . . .	\$27.90	\$31.10	\$31.10	\$31.10
750 . . . .	20.10	22.65	22.65	22.65
P3510 . . . .	7.50	9.25	9.15	9.25
P1842 . . . .	6.95	8.70	8.60	8.70

For above Locks associated with Ornamental Trim see page 711; and for lock-sets with Glass Knobs see pages 736 and 737.

*In Specifying* : Give lock number, style of trim, and finish name or symbol, thus: 234½ × W7000; BZ10.

\*For article on "Metals and Finishes" see page 595, and for Nomenclature of finishes and Explanation of Finish Symbols see page 604.

†For illustration and description of the several styles and sizes of Escutcheon Plates see pages 704 and 705, and for Knobs see pages 708 and 709.

See Note as to Method of Pricing, page 33.



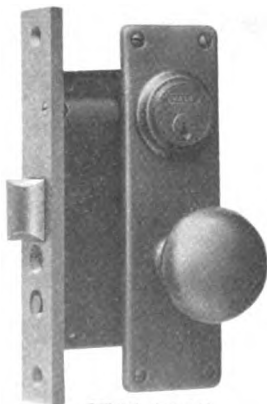

274½ LOCK



790 LOCK

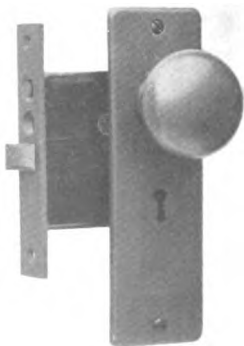

P1742 LOCK

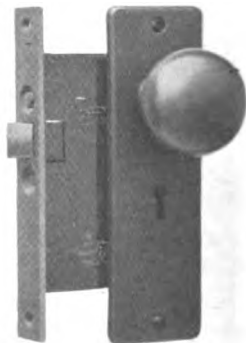

P3510½ LOCK

Lock-sets for Vestibule Doors.

Cuts ¼ Size.

Digitized by Google

## Lock-sets for Vestibule Doors.

TRIM: No. W7000 Series.

Wrought Bronze Buffed (BZ10) or Brass (AZ10).\*

Illustrated on opposite page.

274½ Lock (p. 660); Trim: pair No. W55½ Knobs (p. 708)  
and two Escutcheon Plates, 7½ × 2¼ inches (p. 705)  
Prices: Lock 274½, \$13.20. Trim, \$4.10. . . Set, \$17.30

790 Lock (p. 656); Trim: pair No. W55½ Knobs (p. 708)  
and two Escutcheon Plates, 7½ × 2¼ inches (p. 705)  
Prices: Lock 790, \$11.00. Trim, \$4.10. . . Set, \$15.10

P3510½ Lock (p. 654); Trim: pair No. W56 Knobs (p. 708)  
and one outside Escutcheon Plate, 7½ × 2¼ inches  
(p. 705); Inside, one Rose.  
Prices: Lock P3510½, \$3.30. Trim, \$3.05. . . Set, \$6.35  
Add for 3 Tumbler lock P3530½ (p. 654) 35 cents.

P1742 Lock (p. 653); Trim: pair No. W56 Knobs (p. 708)  
and one outside Escutcheon Plate 7½ × 2¼ inches  
(p. 705); Inside, one Rose.  
Prices: Lock P1742, \$2.65. Trim, \$3.05. . . Set, \$5.70  
Add for 3 Tumbler lock P1743 (p. 653) 35 cents.

## ·Above Locks (in sets) with Various Styles of Plain Trim.†

No.	W7000	7000	W6000	6000
274½ . . .	\$17.30	\$19.20	\$19.20	\$19.20
790 . . .	15.10	17.00	17.00	17.00
P3510½ . . .	6.35	7.30	7.30	7.30
P1742 . . .	5.70	6.65	6.65	6.65

For above Locks associated with Ornamental Trim see page 713, and for lock-sets with Glass Knobs see pages 736 and 737.

*In Specifying:* Give lock number, style of trim, and finish name or symbol thus: 274½ × W7000; BZ10.

\* For article on "Metals and Finishes" see page 595, and for Nomenclature of Finishes and Explanation of Finish Symbols see page 609.

† For illustration and description of the several styles and sizes of Escutcheon Plates see pages 704 and 705, and for Knobs see pages 708 and 709.

See Note as to Method of Pricing, page 33.

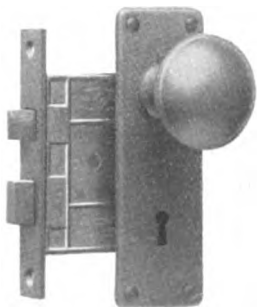

P 2330 LOCK

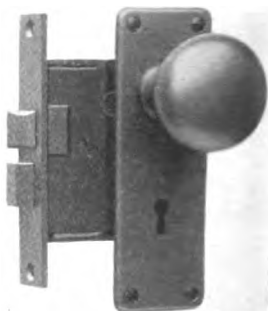

1620 LOCK

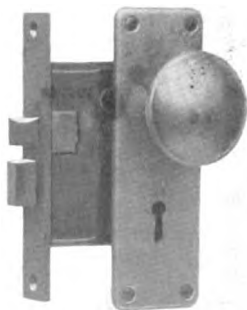

P 1918 LOCK



P 3310 LOCK

Lock-sets for Corridor, Room and Closet Doors.  
Cuts  $\frac{1}{4}$  Size.

## Lock-sets for Corridor, Room and Closet Doors.

TRIM : No. W7000 Series.

Wrought Bronze Buffed (BZ10) or Brass (AZ10).\*

Illustrated on opposite page.

## 3 1/2 Inch Locks.

- P2330 Lock (p. 635); Trim : pair No. W52 Knobs (p. 709)  
and two Escutcheon Plates, 6×2 inches, (p. 705)  
Prices : Lock P2330, \$2.40. Trim, \$2.40. . . . Set, \$4 80
- 1620 Lock (p. 635); Trim : pair No. W56 Knobs (p. 708)  
and two Escutcheon Plates, 6×2 inches, (page 705)  
Prices : Lock 1620, \$2.50. Trim, \$2.70. . . . Set, \$5.20
- P1918 Lock (p. 635); Trim : pair No. W52 Knobs (p. 708)  
and two Escutcheon Plates, 6×2 inches, (p. 705)  
Prices : Lock P1918, \$1.40. Trim, \$2.40. . . . Set, \$3.80  
Add for 3 Tumbler lock P1918 3/4 (p. 635) 35 cents.
- P3310 Lock (p. 634); Trim : pair No. W52 Knobs (p. 708)  
and two Escutcheon Plates, 6×2 inches, (p. 705)  
Prices : Lock P3310, \$1.50. Trim, \$2.40. . . . Set, \$3.90  
Add for 3 Tumbler lock P3330 (p. 634) 35 cents.

## Above Locks (in sets) with Various Styles of Plain Trim.†

No.	W7000	7000	W6000	6000
P2330 . . . . .	\$4.80	\$6.10	\$6.10	\$6.10
1620 . . . . .	5.20	6.50	6.50	6.50
P1918 . . . . .	3.80	5.10	5.10	5.10
P3310 . . . . .	3.90	5.20	5.20	5.20

For above Locks associated with Ornamental Trim see page 715 ; and for lock-sets with Glass Knobs see pages 736 and 737.

*In Specifying* : Give lock number, style of trim, and finish name or symbol, thus : P2330×W7000; BZ10.

\*For article on "Metals and Finishes" see page 595, and for Nomenclature of Finishes and Explanation of Finish Symbols see page 609.

†For illustration and description of the several styles and sizes of Escutcheon Plates see pages 704 and 705, and for Knobs see pages 708 and 709.

See Note as to Method of Pricing, page 33.

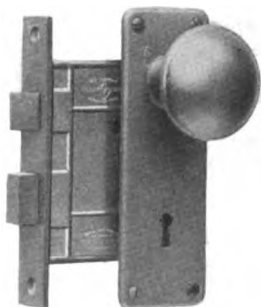
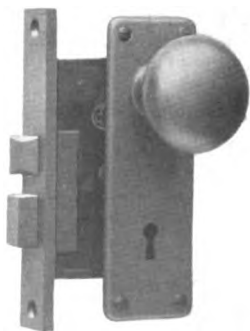
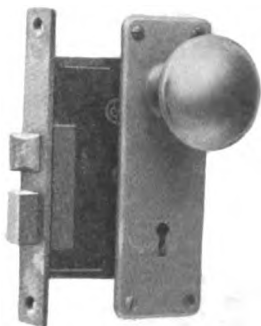
**P2430 LOCK****P2918 LOCK****1420 LOCK****1500 LOCK**

Lock-sets for Corridor, Room and Closet Doors.  
Cuts  $\frac{1}{4}$  Size.

Lock-sets for Corridor, Room and Closet Doors.

TRIM : No. W7000 Series.

Wrought Bronze Buffed (BZ10) or (Brass AZ10).\*

Illustrated on opposite page.

4 Inch Locks.

P2430 Lock (p. 636); Trim : pair No. W52 Knobs (p. 709)  
and two Escutcheon Plates, 6×2 inches (p. 705)  
Prices : Lock P2430, \$2.85. Trim, \$2.40. . . . Set, \$5.25

P2918 Lock (p. 636); Trim : pair No. W52 Knobs (p. 708)  
and two Escutcheon Plates, 6×2 inches (p. 705)  
Prices : Lock P2918, \$2.20. Trim, \$2.40. . . . Set, \$4.60  
Add for 3 Tumbler lock P2918 $\frac{3}{4}$  (p. 636) 35 cents.

4 $\frac{1}{4}$  Inch Locks.

1420 Lock (p. 637); Trim : pair No. W56 Knobs (p. 708)  
and two Escutcheon Plates, 6×2 inches (p. 705)  
Prices : Lock 1420, \$3.00. Trim, \$2.70. . . . Set, \$5.70

1500 Lock (p. 636); Trim : pair No. W56 Knobs (p. 708)  
and two Escutcheon Plates, 6×2 inches (p. 705)  
Prices : Lock 1500, \$3.00. Trim, \$2.70. . . . Set, \$5.70

Above Locks (in sets) with Various Styles of Plain Trim.†

No.	W7000	7000	W6000	6000
P2430 . . . . .	\$5.25	\$6.55	\$6.55	\$6.55
P2918 . . . . .	4.60	5.90	5.90	5.90
1420 . . . . .	5.70	7.00	7.00	7.00
1500 . . . . .	5.70	7.00	7.00	7.00

For above Locks associated with Ornamental Trim see page 717; and for lock-sets with Glass Knobs see pages 736 and 737.

In Specifying : Give lock number, style of trim, and finish name or symbol, thus : P2430×W7000; BZ10.

\*For article on "Metals and Finishes" see page 595, and for Nomenclature of Finishes and Explanation of Finish Symbols see page 609.

†For illustration and description of the several styles and sizes of Escutcheon Plates see pages 704 and 705, and for Knobs see pages 708 and 709.

See Note as to Method of Pricing, page 33.

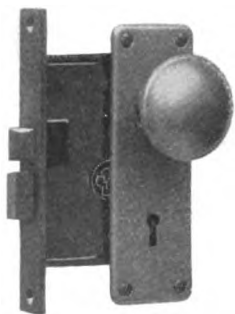

P391B LOCK

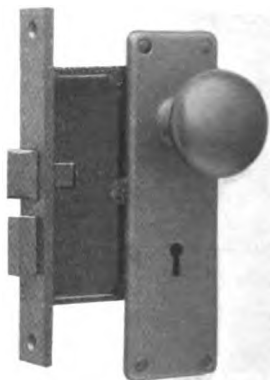

1442 LOCK

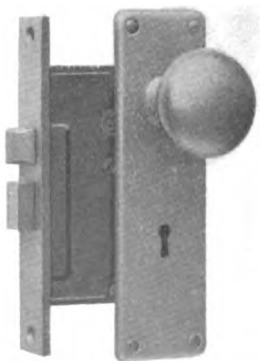

1440 LOCK

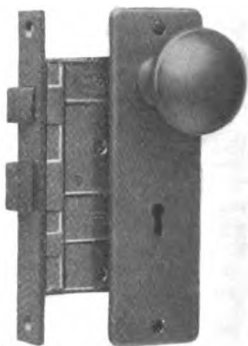

P2530 LOCK

Lock-sets for Corridor, Room and Closet Doors.  
Cuts  $\frac{1}{4}$  Size.

## Lock-sets for Corridor, Room and Closet Doors.

TRIM : No. W7000 Series.

Wrought Bronze Buffed (BZ10) or Brass (AZ10).\*

Illustrated on opposite page.

## 4½ Inch Locks.

- P3918 Lock (p.638); Trim : pair No. W52 Knobs (p. 708) and two Escutcheon Plates, 6×2 inches (p. 705).  
 Prices: Lock P3918, \$2.65. Trim, \$2.40. . . . Set, \$5.05  
 Add for 3 Tumbler lock P3918¼ (p. 638) 35 cents.

## 5 Inch Locks.

WITH TWO BOLTS.

- 1442 Lock (p. 639); Trim : pair No. W56 Knobs (p. 708) and two Escutcheon Plates, 7½×2¼ inches (p. 705)  
 Prices: Lock 1442, \$5.50. Trim, \$3.40. . . . Set, \$8.90
- 1440 Lock (p. 639) Trim : pair No. W56 Knobs (p. 708) and two Escutcheon Plates, 7½×2¼ inches (p. 705)  
 Prices: Lock 1440, \$4.75. Trim, \$3.40 . . . . Set, \$8.15
- P2530 Lock (p. 638); Trim : pair No. W56 Knobs (p. 708) and two Escutcheon Plates, 7½×2¼ inches (p. 705)  
 Prices: Lock P2530, \$4.20. Trim, \$3.40. . . . Set, \$7.60

## Above Locks (in sets) with Various Styles of Plain Trim.†

No.	W7000	7000	W6000	6000
P3918 . . . .	\$5.05	\$6.35	\$6.35	\$6.35
1442 . . . .	8.90	9.80	9.80	9.80
1440 . . . .	8.15	9.05	9.05	9.05
P2530 . . . .	7.60	8.50	8.50	8.50

For above Locks associated with Ornamental Trim see page 719, and for lock-sets with Glass Knobs see pages 736 and 737.

*In Specifying* : Give lock number, style of trim, and finish name or symbol, thus : P3918×W7000; BZ10.

\* For article on "Metals and Finishes" see page 595, and for Nomenclature of Finishes and Explanation of Finish Symbols, see page 609.

† For illustration and description of the several styles and sizes of Escutcheon Plates see pages 704 and 705, and for Knobs see pages 708 and 709.

See Note as to Method of Pricing, page 33.



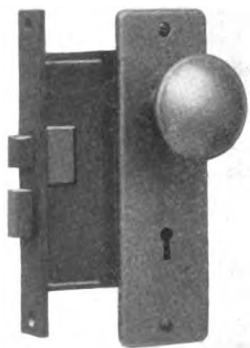

P4918 LOCK.

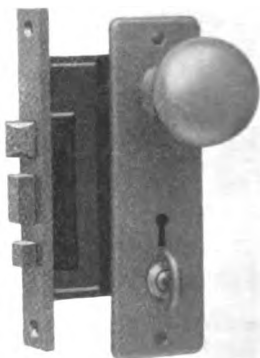

1402 LOCK

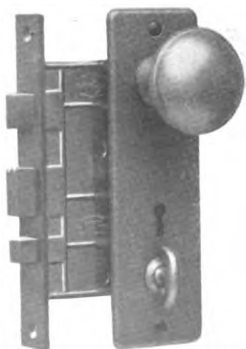

P 2535 LOCK

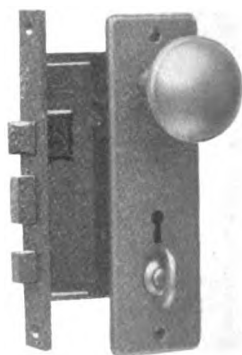

P 5918 1/2 LOCK

Lock-sets for Corridor, Room and Closet Doors.

Cuts  $\frac{1}{4}$  Size.

Digitized by Google

## Lock-sets for Corridor, Room and Closet Doors.

TRIM: No. W7000 Series.

Wrought Bronze Buffed (BZ10) or Brass (AZ10.)§

Illustrated on opposite page.

## 5 Inch Locks—Continued.

WITH TWO BOLTS.

P4918 Lock (p. 638); Trim: pair No. W52 Knobs (p. 708) and two Escutcheon Plates,  $7\frac{1}{2} \times 2\frac{1}{4}$  inches (p. 705)  
 Prices: Lock 4918, \$3.85. Trim, \$3.10. . . . Set, \$6.95  
 Add for 3 Tumbler lock P4918 $\frac{3}{4}$  (p. 638) 35 cents.

WITH THREE BOLTS.

1402 Lock (p. 641); Trim: pair No. W56 Knobs (p. 708) and two Escutcheon Plates, one with Thumb-knob,  $7\frac{1}{2} \times 2\frac{1}{4}$  inches (p. 705.)  
 Prices: Lock 1402, \$4.75. Trim, \$4.20. . . . Set, \$8.95

P2535 Lock (p. 641); Trim: pair No. W56 Knobs (p. 708) and two Escutcheon Plates, one with Thumb-knob,  $7\frac{1}{2} \times 2\frac{1}{4}$  inches (p. 705.)  
 Prices: Lock P2535, \$4.50. Trim, \$4.20. . . . Set, \$8.70

P5918 $\frac{1}{2}$  Lock (p. 640); Trim: pair No. W52 Knobs (p. 708) and two Escutcheon Plates, one with Thumb-knob,  $7\frac{1}{2} \times 2\frac{1}{4}$  inches (p. 705.)  
 Prices: Lock P5918 $\frac{1}{2}$ , \$4.10. Trim, \$3.90. . . . Set, \$8.00  
 Add for 3 Tumbler lock P5918 $\frac{3}{4}$  (p. 640) 35 cents.

Above Locks (in sets) with Various styles of Plain Trim.†

No.	W7000	7000	W6000	6000
P4918 . . . . .	\$6.95	\$ 8.55	\$ 8.55	\$ 8.55
1402 . . . . .	8.95	10.85	10.85	10.85
P2535 . . . . .	8.70	10.60	10.60	10.60
P5918 $\frac{1}{2}$ . . . . .	8.00	9.90	9.90	9.90

For above Locks associated with Ornamental Trim see page 721; and for lock-sets with Glass Knobs see page 736 and 737.

*In Specifying:* Give lock number, style of trim, and finish name or symbol, thus: P4918  $\times$  W7000; BZ10.

\*For article on "Metals and Finishes" see page 595, and for Nomenclature of Finishes and Explanation of Finish Symbols see page 609.

†For illustration and description of the several styles of Escutcheon Plates see pages 704 and 705, and for Knobs see pages 708 and 709.

See Note as to Method of Pricing, page 33.

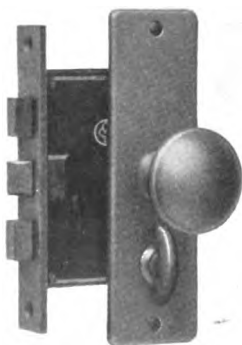

1504 LOCK



1505 LOCK

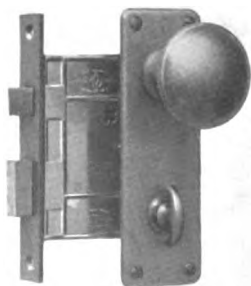

P 2400 LOCK



P 2405 LOCK

Lock-sets for Communicating Doors.  
Cuts  $\frac{1}{4}$  Size.

## Lock-sets for Communicating Doors.

TRIM : No. W7000 Series.

Wrought Bronze Buffed (BZ10) or Brass (AZ10.)\*

Illustrated on opposite page.

**P2400** Lock (p. 626); Trim : pair No. W56 Knobs (p. 708)  
and two Escutcheon Plates with Thumb-knobs, 6×2  
inches (p. 705.)  
Prices : Lock P2400, \$3.30. Trim, \$4.30. . . , Set, \$7.60

**P2405** Lock (p. 625); Trim : pair No. W56 Knobs (p. 708)  
and two Escutcheon Plates, one with Thumb-knob, 6×2  
inches (p. 705.)  
Prices : Lock P2405, \$2.40. Trim \$3.50. . . . Set, \$5.90.

**1504** Lock (p. 626); Trim : pair No. W56 Knobs (p. 708)  
and two Escutcheon Plates with Thumb-knob, 7½×2¼  
inches (p. 705.)  
Prices : Lock 1504, \$3.30. Trim, \$5.00. . . . Set, \$8.30

**1505** Lock (p. 625); Trim : pair No. W56 Knobs (p. 708)  
and two Escutcheon Plates, one with Thumb-knob,  
7½×2¼ inches (p. 705.)  
Prices : Lock 1505, \$2.65. Trim, \$4.20. . . . Set, \$6.85

### Above Locks (in sets) with Various Styles of Plain Trim. †

No.	W7000	7000	W6000	6000
P2400 . . . . .	\$7.60	\$ 8.90	\$ 8.90	\$ 8.90
P2405 . . . . .	5.90	7.20	7.20	7.20
1504 . . . . .	8.30	10.20	10.20	10.20
1505 . . . . .	6.85	8.75	8.75	8.75

For above Locks associated with Ornamental Trim see page 723; and for lock-sets with Glass Knobs see pages 736 and 737.

*In Specifying* : Give lock number, style of trim, and finish name or symbol, thus : P2400×W7000; PA10.

\*For articles on "Metals and Finishes" see page 595, and for Nomenclature of Finishes and Explanation of Finish Symbols see page 609.

†For illustration and description of the several styles and sizes of Escutcheon Plate see pages 704 and 705, and for Knobs see page 708 and 709.

See Note as to Method of Pricing, page 33.

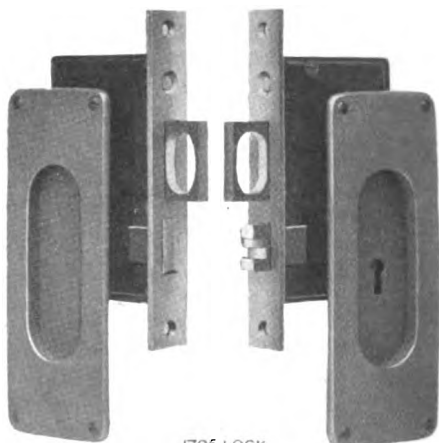

1706 LOCK

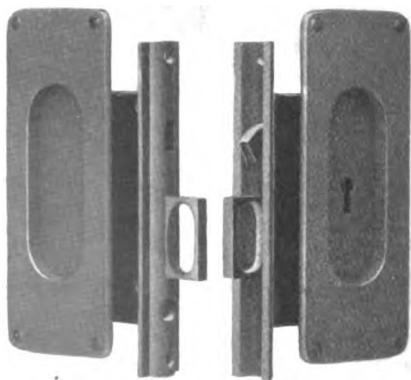
P 3936 $\frac{1}{2}$  LOCK

Lock-sets for Sliding Doors.  
Cuts  $\frac{1}{4}$  Size.

## Lock-sets for Sliding Doors.

TRIM : No. 70854 Series.

Cast Bronze Buffed (BZ10) or Brass (AZ10).\*

Illustrated on opposite page.

- 1706½ Lock (p. 650); Flat Front, for Single Doors; Trim:  
Two Cup Escutcheons, 8×3 inches (p. 706).  
Prices: Lock 1706½, \$6.20. Trim, \$5.80 . . . Set, \$12.00
- 1706 Lock (p. 650); Flat Front, for Double Doors; Trim:  
Four Cup Escutcheons, 8×3 inches (p. 706).  
Prices: Lock 1706, \$8.40. Trim, \$11.60. . . Set, \$20.00
- 1726 Lock (p. 650); Astragal Front, for Double Doors;  
Trim: Four Cup Escutcheons, 8×3 inches (p. 706).  
Prices: Lock 1726, \$10.50. Trim, \$11.60. . . Set, \$22.10
- P3912½ Lock (p. 650); Flat Front, for Single Doors; Trim:  
Two Cup Escutcheons, 6×2½ inches (p. 706).  
Prices, Lock P3912½, \$2.55. Trim, \$3.20. . . Set, \$5.75
- P3924½ Lock (p. 650); Flat Front, for Double Doors; Trim:  
Four Cup Escutcheons, 6×2½ inches (p. 706).  
Prices: Lock P3924½, \$3.45. Trim, \$6.40. . . Set, \$9.85
- P3936½ Lock (p. 650); Astragal Front, for Double Doors;  
Trim: Four Cup Escutcheons, 6×2½ inches (p. 706)  
Prices: Lock P3936½, \$4.75. Trim, \$6.40. . . Set, \$11.15

Above Lock (in sets) with Various Styles of Plain Trim.†

No.	854	850	W7854	W7850	W814
1706½	\$12.00	\$9.40	. . .	. . .	. . .
1706	20.00	14.80	. . .	. . .	. . .
1726	22.10	16.90	. . .	. . .	. . .
P3912½	. . .	5.75	\$4.15	\$3.65	\$3.45
P3924½	. . .	9.85	6.65	5.65	5.25
P3936½	. . .	11.15	7.95	6.95	6.55

For Locks associated with Ornamental Trim see page 725.

In Specifying: Give lock number, style of trim, and finish name or symbol, thus: 1706×70854; BZ10.

\*For article on "Metals and Finishes" see page 595, and for Nomenclature of Finishes and Explanation of Finish Symbols see page 906.

† For full line of Cup Escutcheons, including those priced above with locks, see pages 706 and 707.

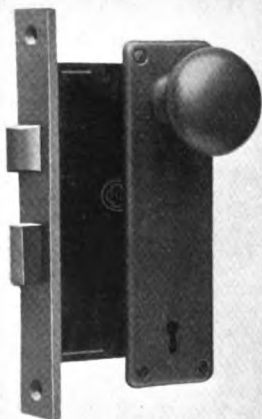

1685 LOCK



1695 LOCK

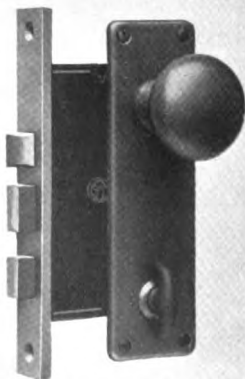

1680 LOCK



P1793 LOCK

Lock-sets for Hotel Doors.  
Cuts  $\frac{1}{4}$  Size.

## Lock-sets for Hotel Doors.

TRIM : No. W7000 Series.

Wrought Bronze Buffed (BZ10) or Brass (AZ10.)\*

Illustrated on opposite page.

- P1793 Lock (p. 641); Trim : pair No. W52 Knobs (p. 708) and two Escutcheon Plates,  $7\frac{1}{2} \times 2\frac{1}{4}$  inches, (p. 705).  
Prices : Lock P1793, \$4.25. Trim, \$3.10. . . Set, \$7.35
- 1680 Lock (p. 642); Trim : pair No. W56 Knobs (p. 708) and two Escutcheon Plates, one with Thumb-knob,  $7\frac{1}{2} \times 2\frac{1}{4}$  inches (p. 705.)  
Prices : Lock 1680, \$8.25. Trim, \$4.20. . . . Set, \$12.45
- 1695 Lock (p. 644); Trim : pair No. W56 Knobs (p. 708) and two Escutcheon Plates, one with Thumb-knob,  $7\frac{1}{2} \times 2\frac{1}{4}$  inches (p. 705.)  
Prices : Lock 1695, \$11.00. Trim, \$4.20. . . . Set, \$15.20
- 1685 Lock (p. 643); Trim : pair No. W56 Knobs (p. 708) and two Escutcheon Plates,  $7\frac{1}{2} \times 2\frac{1}{4}$  inches (p. 705.)  
Prices : Lock 1685, \$12.00. Trim, \$3.40. . . . Set, \$15.40

## Above Locks (in sets) with Various Styles of Plain Trim†.

No.	W7000	7000	W6000	6000
P1793 . . . . .	\$ 7.35	\$ 9.55‡	\$ 9.55‡	\$ 9.55‡
1680 . . . . .	12.45	14.35	14.35	14.45
1695 . . . . .	15.20	17.10	17.10	17.10
1685 . . . . .	15.40	17.30	17.30	17.30

For above Locks associated with Ornamental Trim see page 727; and for lock-sets with Glass Knobs see page 736 and 737.

*In Specifying* : Give lock number, style of trim, and finish name or symbol, thus : P1793 X W7000; BZ10.

\*For article on "Metals and Finishes" see page 565, and for Nomenclature of Finishes and Explanation of Finish Symbols see page 609.

†For illustration and description of the several styles and sizes of Escutcheon Plates see pages 704 and 705, and for Knobs see pages 708 and 709.

‡With W56 Knobs.

See Note as to Method of Pricing, page 33.



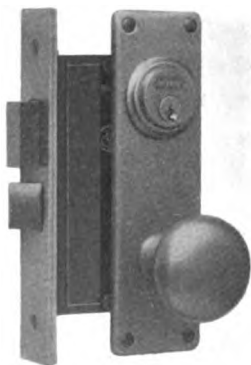

614 LOCK

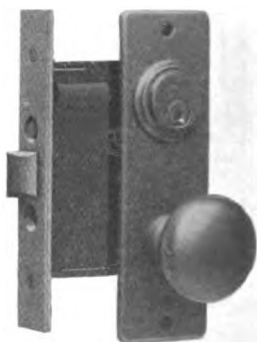

770 LOCK

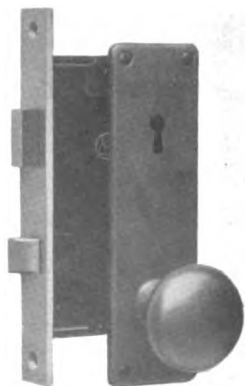

1614 LOCK

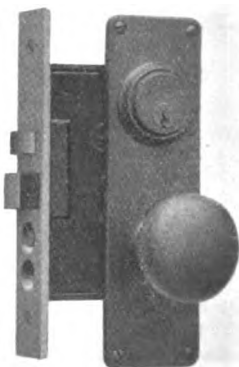

656 H LOCK

Lock-sets for Office Doors.  
Cuts  $\frac{1}{4}$  Size.

## Lock-sets for Office Doors.

TRIM No. W7000 Series.

Wrought Bronze Buffed (BZ10) or Brass (AZ10).\*

Illustrated on opposite page.

- 770 Lock (p. 647); Trim: pair No. W56 Knobs (p. 708)  
and two Escutcheon Plates,  $7\frac{1}{2} \times 2\frac{1}{4}$  inches (p. 705).  
Prices: Lock 770, \$12.15. Trim, \$3.65. . . . Set, \$15.80
- 656H Lock (p. 646); Trim: pair No. W56 Knobs (p. 708)  
and two Escutcheon Plates,  $7\frac{1}{2} \times 2\frac{1}{4}$  inches (p. 705).  
Prices: Lock 656H, \$15.65. Trim, \$3.65. . . . Set, \$19.30
- 614 Lock (p. 645); Trim: pair No. W56 Knobs (p. 708)  
and two Escutcheon Plates,  $7\frac{1}{2} \times 2\frac{1}{4}$  inches (p. 705).  
Prices: Lock 614, \$15.80. Trim, \$3.40. . . . Set, \$19.20
- 1614 Lock (p. 645); Trim: pair No. W56 Knobs (p. 708)  
and two Escutcheon Plates,  $7\frac{1}{2} \times 2\frac{1}{4}$  inches (p. 705).  
Prices: Lock 1614, \$8.80. Trim, \$3.40. . . . Set, \$12.20

## Above Locks (in sets) with Various Styles of Plain Trim.†

No.	W7000	7000	W6000	6000
770 . . . . .	\$15.80	\$17.70	\$17.70	\$17.70
656H . . . . .	19.30	21.20	21.20	21.20
614 . . . . .	19.20	21.10	21.10	21.10
1614 . . . . .	12.20	14.10	14.10	14.10

For above Locks associated with Ornamental Trim see page 729; and for lock-sets with Glass Knobs see pages 736 and 737.

*In Specifying* : Give lock number, style of trim, and finish name or symbol, thus: 770 X W7000; BZ10.

\* For article on "Metals and Finishes" see page 595, and for Nomenclature of Finishes and Explanation of Finish Symbols see page 600.

† For illustration and description of the several styles and size of Escutcheon Plates see pages 704 and 705, and for Knobs see pages 708 and 709.

See Note as to Method of Pricing, page 33.

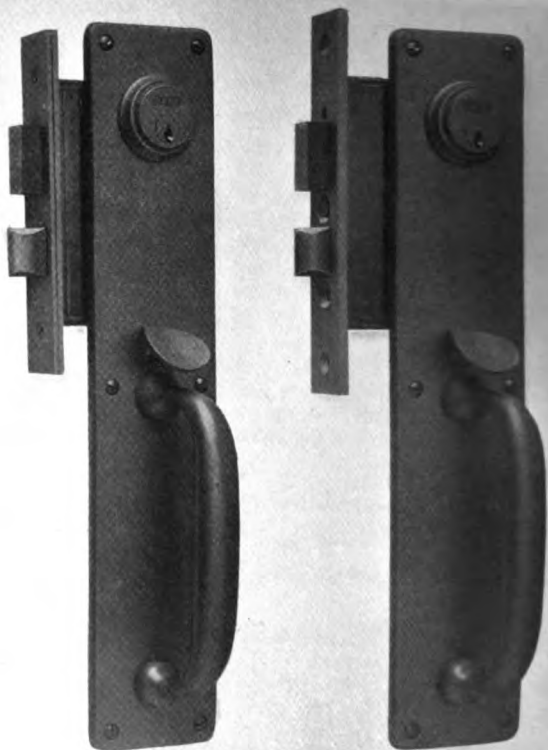

414 LOCK

732 LOCK

### Lock-sets for Store Doors.

TRIM:—714 Line, Cast Bronze Buffed (BZ10) or Brass (AZ10).

414 Lock (p. 665); Trim: pair 714 Handles, 15×3 inches (p. 743).  
 Prices: Lock 414, \$13.20. Trim, \$13.50. Set, \$26.70.

732 Lock (p. 666); Trim: pair 714 Handles, 15×3 inches (p. 743).  
 Prices: Lock 732, \$15.80. Trim, \$13.50. Set, \$29.30.

For above Locks associated with Ornamental Trim see page 730.

*In Specifying:* Give lock number, style of trim, and finish name or symbol, thus: 414×714 Handle; BZ10.

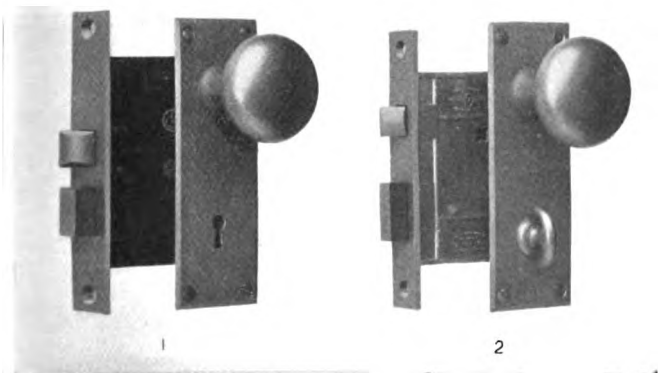

## Plain Trim

With Square Corners and Beveled Edges.

W6000 and 6000 Series.

A complete series of Escutcheon Plates suitable for association with all locks is made in this style.

There are two grades as follows :—

**W6000** Wrought Metal, solid rolled ; price in “sets” on pages 683 to 701.  
Escutcheon Plates only priced on page 705.

**6000** Cast Metal ; priced in “sets” on pages 683 to 701. Escutcheon  
Plates only priced on page 705.

For Knobs see pages 708 and 709.

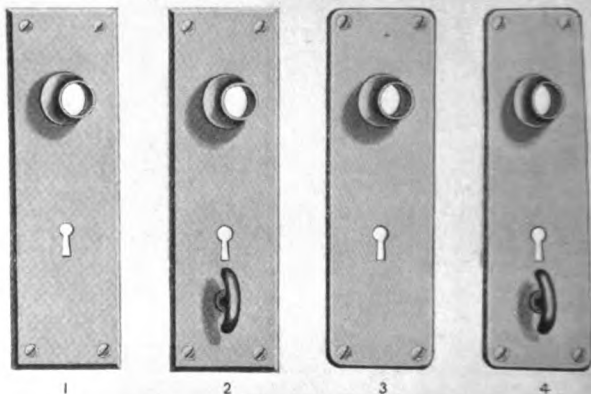

1  
Square Corners and Beveled Edges.  
Cast and Wrought Bronze.

2  
Round Corners and Round Edges.  
Cast and Wrought Bronze.

## Plain Escutcheon Plates.

These are made in the four styles illustrated above, and in various sizes as listed and priced on opposite page.

The appropriate size of Plain Escutcheon Plates for the various Locks are shown on page 682 to 702, containing illustrations of lock-sets with plain trim.

For plates with Thumb-pieces add 80 cents each to list prices.

For Knobs suitable for association with Plain Escutcheon Plates see pages 708 and 709.

For Key Plates see opposite page. For Cup Escutcheons for Sliding Door Locks see pages 706 and 707.

## Plain Escutcheon Plates.

Priced in Buffed Bronze or Brass.\*

## SQUARE CORNERS AND BEVELED EDGES.

Figs. 1 and 2, page 704.

Cast Metal—6000 Series:

5 $\frac{1}{2}$ $\times$ 1 $\frac{3}{4}$ inches, each \$ .90	Size, 10 $\times$ 2 $\frac{3}{4}$ inches, each \$3.10
6 $\times$ 2 " " 1.10	" 2 $\times$ 1 $\frac{3}{4}$ " (Key
7 $\frac{1}{2}$ $\times$ 2 $\frac{1}{4}$ " " 1.75	Plate) . . . each, .25
9 $\times$ 2 $\frac{1}{2}$ " " 2.50	

Wrought Metal, Solid Rolled—W6000 Series:

5 $\frac{1}{2}$ $\times$ 1 $\frac{3}{4}$ inches, each \$ .90	Size, 9 $\times$ 2 $\frac{1}{2}$ inches, each \$2.50
6 $\times$ 2 " " 1.10	" 2 $\times$ 1 $\frac{1}{4}$ " (Key
7 $\frac{1}{2}$ $\times$ 2 $\frac{1}{4}$ " " 1.75	Plate). . . . each .15

## ROUND CORNERS AND ROUND EDGES.

Figs. 3 and 4, page 704.

Cast Metal—7000 Series:

5 $\frac{1}{2}$ $\times$ 1 $\frac{5}{8}$ inches, each, \$ .90	Size, 10 $\times$ 2 $\frac{3}{4}$ inches, each \$3.10
6 $\times$ 2 " " 1.10	" 1 $\frac{3}{4}$ $\times$ 1 $\frac{1}{8}$ " (Key
7 $\frac{1}{2}$ $\times$ 2 $\frac{1}{4}$ " " 1.75	Plate). . . . each, .25
9 $\times$ 2 $\frac{1}{2}$ " " 2.50	

Wrought Metal, Reversed—W7000 Series:

5 $\frac{1}{2}$ $\times$ 1 $\frac{1}{2}$ inches, each, \$ .35	Size, 9 $\times$ 2 $\frac{1}{2}$ inches, each \$1.20
5 $\frac{1}{2}$ $\times$ 1 $\frac{5}{8}$ " " .35	" 10 $\times$ 2 $\frac{3}{4}$ " " 1.50
6 $\times$ 2 " " .45	" 1 $\frac{3}{4}$ $\times$ 1 " (Key
7 $\frac{1}{2}$ $\times$ 2 $\frac{1}{4}$ " " .80	Plate). . . . each, .10

For Plates with Thumb-pieces add 80 cents each to above prices.

For Knobs for these Plates, see pages 708 and 709.

For Plain Lock-sets, see pages 681 to 703.

\*Certain styles of Escutcheon Plates are also made in Steel and Iron for Bower-Barff  
 and in various platings. For article on "Metal and Finishes" see page 595,  
 and for Nomenclature of Finishes and Explanation of Finish Symbols see page 609.



1

Round  
Round Edges.



2

Square  
Straight Edges.



3

Square  
Beveled Edges.

## Plain Cup Escutcheons.

For Sliding Door Locks.

Priced in Buffed Bronze or Brass.\*

### CAST METAL.

No.	850	Square, style Fig. 2	6 × 2½ inches,	pair,	\$5
"	6850	" " " 3	6 × 2½ "	"	3
"	854	" " " 2	8 × 3 "	"	5
"	6854	" " " 3	8 × 3 "	"	5
"	70850	Round, " " 1	6 × 2½ "	"	5
"	70854	" " " 1	8 × 3 "	"	5

### WROUGHT METAL.

No.	W5850	Square, style Fig. 3	4¼ × 2¼ inches,	pair,	\$8
"	W814	Round, " " 1	4 × 2½ "	"	8
"	W7850	" " " 1	6 × 2 "	"	8
"	W7854	" " " 1	7¼ × 2¼ "	"	8

Cup Escutcheons are also made in Steel and Iron with Bower-Barff plated Finishes.

The Straight Edges of Cup Escutcheons Nos. 850 and 854 will be finished not polished, if wanted for setting in flush.

\* For article on "Metals and Finishes" see page 595, and for Nomenclature Finishes and Explanation of Finish Symbols see page 607.



800



827



19



19¼



855

## Plain Cup Escutcheons.

For Sliding Door Locks.

With T Handles, &c.

Priced in Buffed Bronze or Brass.\*

### CAST METAL.

No. 800.	10	× 3½ ins.	For Locks 234S, 274S out . . . . .	pair,	\$13.20
" 810.	"	"	" " 244½S, out, . . . . .	"	11.90
" 811.	"	"	" " 244½S, in, . . . . .	"	14.30
" 824.	"	"	" " 234S, in, . . . . .	"	13.20
" 827.	3½ × 3½	"	" " 274S, in, . . . . .	"	8.80
" 855.	8 × 3	"	" " 1704, 1704, 1724, . . . . .	"	10.00
" 19.	3½ × 1¾	"	" " P1902½, P1904½, P1905½, . . . . .	"	2.65
" 19¼.	"	"	" " P1904, P1905, . . . . .	"	2.65

Cup Escutcheons are also made in Iron with Bower-Barff and plated Finishes.

\*For article on "Metals and Finishes" see page 595, and for Nomenclature of Finishes and Explanation of Finish Symbols see page 609.





SPHEROID



OVAL



SPHERE



BOX



BEAD



BAND

## Metal Door Knobs.

Priced in Buffed Bronze or Brass.\*

No.	15	Spheroid,	Cast,	$2\frac{1}{2} \times 2\frac{1}{2}$ ins.	Per pair.
"	$15\frac{1}{2}$	"	"	$2\frac{1}{2} \times 2\frac{1}{4}$	" "
"	16	"	"	$2\frac{1}{4} \times 2\frac{1}{4}$	" "
"	W55	"	Wrought,	$2\frac{1}{2} \times 2\frac{1}{2}$	" "
"	W55 $\frac{1}{2}$	"	"	$2\frac{1}{2} \times 2\frac{1}{4}$	" "
"	W56	"	"	$2\frac{1}{4} \times 2\frac{1}{4}$	" "
"	13	Oval†	Cast,	$3 \times 3$	" "
"	$13\frac{1}{2}$	"	"	$3 \times 2\frac{1}{2}$	" "
"	14	"	"	$2\frac{1}{2} \times 2\frac{1}{2}$	" "
"	W13	"	Wrought,	$3 \times 3$	" "
"	W13 $\frac{1}{2}$	"	"	$3 \times 2\frac{5}{8}$	" "
"	W14	"	"	$2\frac{5}{8} \times 2\frac{5}{8}$	" "

(Continued on next page.)

Price of Knobs includes Triplex Spindle, but no Roses. For Cast Knobs add 40 cents per pair to above prices.

\*For article on "Metals and Finishes" see page 595, and for Nomenclature, Finishes and Explanation of Finish Symbols see page 609.

†The vertical dimensions only of the outer and inner knobs on doors are given.

Door Knobs.—(Continued.)

Illustrated on opposite page.

Priced in Buffed Bronze or Brass \*

No. 85	Sphere,	Cast	2 1/2 X 2 1/2 ins.	Per pair, \$3.60
" 85 1/2	"	"	2 1/2 X 2 1/4 "	" " 3.25
" 86	"	"	2 1/4 X 2 1/4 "	" " 2.90
" W120	Box, Wrought,		2 1/4 X 2 1/4 "	" " 1.15
" W52	Bead,	"	2 1/4 X 2 1/4 "	" " 1.50
" W39	Band,	"	2 1/2 X 2 1/2 "	" " 2.25
" W39 1/2	"	"	2 1/2 X 2 1/4 "	" " 1.85
" W40	"	"	2 1/4 X 2 1/4 "	" " 1.45

Price of Knobs includes Triplex Spindle but no Roses. For Cast Roses add 50 cents per pair to above prices.



60



70



80

Wood Door Knobs.

Shanks and Roses in Buffed Bronze or Brass.

No. 60	Imitation Cherry,	2 1/4 X 2 1/4 ins.	Per pair, \$1.00
" 70	"	2 1/4 X 2 1/4 "	" " 1.10
" 80	"	2 1/4 X 2 1/4 "	" " 1.20

Price of Knobs includes Triplex Spindle but no Roses. For Cast Bronze or Brass Roses, Buffed, add 40 cents per pair to above prices. For Wood Roses add 10 cents per pair to above prices.

Knobs will be furnished finished in Imitation Apple, Ash, Beech, Stained Cherry, Mahogany, Maple, Oak or Antique Oak at same price. For genuine Apple or Walnut add 15 cents per pair to above prices.

Knobs associated with Front Door, Vestibule and Office Locks require a Swivel Spindle, for which add 25 cents each.

\*For article on "Metals and Finishes" see page 595, and for Nomenclature of Finishes and Explanation of Finish Symbols see page 609.



234 1/2 LOCK



750 LOCK



P 1842 LOCK



P 3510 LOCK

Lock-sets for: Front Doors.  
Cuts  $\frac{1}{4}$  Size.

## Lock-sets for Front Doors.

TRIM: Cluny Design.

Cast Bronze, Old Copper Finish (CX22).\*

Illustrated on opposite page.

234½ Lock (p. 660); Trim: pair No. 55½ Knobs (p. 734) and two Escutcheon Plates, 12⅝ × 3⅜ inches, (p. 734).  
Prices: Lock 234½, \$22.40. Trim, \$13.05. . . Set, \$35.45

750 Lock (p. 656); Trim: pair No. 55½ Knobs (p. 734) and two Escutcheon Plates, 12⅝ × 3⅜ inches, (p. 734).  
Prices: Lock 750, \$14.50. Trim, \$13.85. . . Set, \$28.35

P3510 Lock (p. 654); Trim: pair No. 56 Knobs (p. 734) and two Escutcheon Plates; Outside, 10 × 2½ inches; Inside, 1⅞ × ¾ inches, (p. 735) and Plain Rose.  
Prices: Lock P3510, \$3.65. Trim, \$7.10. . . Set, \$10.75  
Add for 3 Tumbler lock P3533 (p. 654) 70 cents.

P1842 Lock (p. 652); Trim: pair No. 56 Knobs (p. 734) and two Escutcheon Plates; Outside, 10 × 2½ inches; Inside, 1⅞ × ¾ inches, (p. 735) and Plain Rose.  
Prices: Lock P1842, \$3.10. Trim, \$7.10. . . Set, \$10.20  
Add for 3 Tumbler lock P1843 (p. 652) 35 cents

## Above Locks (in sets) with Trim of Other Designs.

Lock trim in Ornamental Designs is shown on pages 235 to 581. For index by Schools see page 236, and for index alphabetically arranged see page 244. For method of pricing see page 33.

Example: If 234½ lock is wanted with Chambord trim in same finish, increase price for Cluny trim given above, by using the multiplier for Chambord, viz.: 37 (p. 437). This gives the value of Chambord trim as \$48.30, to which add value of lock as above, \$22.40, making value of lock-set in Chambord design \$70.70.

If the trim is different on the opposite side of door, ascertain value of complete trim in each design; add these together and take one-half of their sum. Adding this to the value of the lock will give the value of the lock-set with mixed trim.

For above Locks associated with Plain Trim see page 683; and for lock-sets with Glass Knobs see pages 736 and 737.

*In Specifying:* Give lock number, name of design and finish name or symbol, thus: 234½, Cluny; CX22.

\*For article on "Metals and Finishes" see page 595, and for Nomenclature of Finishes and explanation of Finish Symbols see page 609.



274 1/2 LOCK



790 LOCK



P 1742 LOCK



P 3510

Lock-sets for Vestibule Doors.  
Cuts  $\frac{1}{4}$  Size.

## Lock-sets for Vestibule Doors.

TRIM: Cluny Design.

Cast Bronze, Old Copper Finish (CX22).\*

Illustrated on opposite page.

274½ Lock (p. 660); Trim: pair No. 55½ Knobs (p. 734) and one outside Escutcheon Plate,  $12\frac{5}{8} \times 3\frac{3}{8}$  inches (p. 734); inside, Plain Rose.

Prices: Lock 274½, \$13.20. Trim, \$8.65. . . Set, \$21.85

790 Lock (p. 656); Trim: pair No. 55½ Knobs (p. 734) and one outside Escutcheon Plate,  $12\frac{5}{8} \times 3\frac{3}{8}$  inches (p. 734); inside, Plain Rose.

Prices: Lock 790, \$11.00. Trim, \$8.65. . . Set, \$19.65

P3510½ Lock (p. 654); Trim: pair No. 56 Knobs (p. 734) and one outside Escutcheon Plate,  $8\frac{1}{2} \times 2\frac{1}{2}$  inches, (p. 734); inside, Plain Rose.

Prices: Lock P3510½, \$3.30. Trim, \$6.10. . . Set, \$9.40

Add for 3 Tumbler lock P3530½ (p. 654) 35 cents.

P1742 Lock (p. 653); Trim: pair No. 56 Knobs (p. 734) and one outside Escutcheon Plate,  $8\frac{1}{2} \times 2\frac{1}{2}$  inches (p. 734); inside, Plain Rose.

Prices: Lock P1742, \$2.65. Trim, \$6.10. . . Set, \$8.75

Add for 3 Tumbler lock P1743 (p. 653) 35 cents.

## Above Locks (in sets) with Trim of Other Designs.

Lock trim in Ornamental Designs is shown on pages 235 to 581. For index by Schools see page 236, and for index alphabetically arranged see page 244. For method of pricing see page 33.

Example: If 274½ lock is wanted with Chambord trim in same finish, increase price for Cluny trim given above, by using the multiplier for Chambord, viz: 3.7 (page 437). This gives the value of Chambord trim as \$32.00, to which add value of lock as above, \$13.20, making value of lock-set in Chambord design, \$45.20.

If the trim is different on the opposite side of door, ascertain value of complete trim in each design; add these together and take one-half of their sum. Adding this to the value of the lock will give the value of the lock-set with mixed trim.

For above Locks associated with Plain Trim see page 685; and for lock-sets with Glass Knobs see pages 736 and 737.

*In Specifying:* Give lock number, name of design and finish name or symbol, thus: 274½, Cluny; CX22.

\*For article on "Metals and Finishes" see page 595, and for Nomenclature of Finishes and Explanation of Finish Symbols see page 600.



P2330 LOCK



1620 LOCK



P1918 LOCK



P3310 LOCK

Lock-sets for Corridor, Room and Closet Doors.  
Cuts  $\frac{1}{4}$  Size.

## Lock-sets for Corridor, Room and Closet Doors.

TRIM: Cluny Design.

Cast Bronze, Old Copper Finish (CX22).\*

Illustrated on opposite page.

## 3 1/2 Inch Locks.

- P2330 Lock (p. 635); Trim: pair No. 56 Knobs (p. 734) and two Escutcheon Plates, 8 1/2 x 2 1/2 inches (p. 734).  
Prices: Lock P2330, \$2.40. Trim, \$8.00. . . . Set, \$10.40
- 1620 Lock (p. 635); Trim: pair No. 56 Knobs (p. 734) and two Escutcheon Plates, 8 1/2 x 2 1/2 inches (p. 734).  
Prices: Lock 1620, \$2.50. Trim, \$8.00. . . . Set, \$10.50
- P1918 Lock (p. 635); Trim: pair No. 56 Knobs (p. 734) and two Escutcheon Plates, 8 1/2 x 2 1/2 inches (p. 734)  
Prices: Lock P1918, \$1.40. Trim, \$8.00. . . . Set, \$9.40  
Add for 3 Tumbler lock P1918 3/4 (p. 635) 35 cents.
- P3310 Lock (p. 634); Trim: pair No. 56 Knobs (p. 734) and two Escutcheon Plates, 8 1/2 x 2 1/2 inches (p. 734)  
Prices: Lock P3310, \$1.50. Trim, \$8.00. . . . Set, \$9.50  
Add for 3 Tumbler lock P3330 (p. 634) 35 cents.

## Above Locks (in sets) with Trim of Other Designs.

Lock trim in Ornamental Designs is shown on pages 235 to 581. For index by Schools see page 236, and for index alphabetically arranged see page 244. For method of pricing see page 33.

Example: If P2330 lock is wanted with Chambord trim, in same finish, increase price for Cluny trim given above, by using the multiplier for Chambord viz.: 3.7 (page 437). This gives the value of Chambord trim as \$29.60, to which add value of lock as above, \$2.40, making value of lock-set in Chambord design, \$32.00.

If the trim is different on the opposite side of door, ascertain value of complete trim in each design; add these together and take one-half of their sum. Adding this to the value of the lock will give the value of the lock-set with mixed trim.

For above Locks associated with Plain Trim see page 687; and for lock-sets with Glass Knobs see pages 736 and 737.

In Specifying: Give lock number, name of design and finish name or symbol, thus: P2330, Cluny; CX22.

\*For article on "Metals and Finishes" see page 595, and for Nomenclature of Finishes and Explanation of Finish Symbols, see page 609.





P 2430 LOCK



P 2918 LOCK



1420 LOCK



1500 LOCK

Lock-sets for Corridor, Room and Closet Doors.  
Cuts  $\frac{1}{4}$  Size.

## Lock-sets for Corridor, Room and Closet Doors.

TRIM: Cluny Design.

Cast Bronze, Old Copper Finish (CX22).

Illustrated on opposite page.

## 4 Inch Locks.

P2430 Lock (p. 636); Trim: pair No. 56 Knobs (p. 734)  
and two Escutcheon Plates,  $8\frac{1}{2} \times 2\frac{1}{2}$  inches (p. 734).  
Prices: Lock P2430, \$2.85. Trim, \$8.00. . . . Set, \$10.85

P2918 Lock (p. 636); Trim: pair No. 56 Knobs (p. 734)  
and two Escutcheon Plates,  $8\frac{1}{2} \times 2\frac{1}{2}$  inches (p. 734).  
Prices: Lock P2918, \$2.20 Trim, \$8.00. . . . Set, \$10.20  
Add for 3 Tumbler lock P2918 $\frac{3}{4}$  (p. 636) 35 cents.

4  $\frac{1}{4}$  Inch Locks.

1420 Lock (p. 637); Trim: pair No. 56 Knobs (p. 734)  
and two Escutcheon Plates,  $8\frac{1}{2} \times 2\frac{1}{2}$  inches (p. 734).  
Prices: Lock 1420, \$3.00. Trim, \$8.00. . . . Set, \$11.00

1500 Lock (p. 636); Trim: pair No. 56 Knobs (p. 734)  
and two Escutcheon Plates,  $8\frac{1}{2} \times 2\frac{1}{2}$  inches (p. 734).  
Prices: Lock 1500, \$3.00. Trim, \$8.00. . . . Set, \$11.00

## Above Locks (in sets) with Trim of Other Designs.

Lock trim in Ornamental Designs is shown on pages 235 to 581. For index by Schools see page 236, and for index alphabetically arranged see page 244. For method of pricing see page 33.

Example: If P2430 lock is wanted with Chambord trim in same finish, increase price for Cluny trim given above, by using the multiplier for Chambord, viz: 3.7 (page 437). This gives the value of Chambord trim as \$29.60, to which add value of lock as above, \$2.85, making value of lock-set in Chambord design \$32.45.

If the trim is different on the opposite side of door, ascertain value of complete trim in each design; add these together and take one-half of their sum. Adding this to the value of the lock will give the value of the lock-set with mixed trim.

For above Locks associated with Plain Trim see page 689; and for lock-sets with Glass Knobs see pages 736 and 737.

*In Specifying:* Give lock number, name of design and finish name or symbol, thus: P2430, Cluny; CX22.

\*For article on "Metals and Finishes" see page 595, and for Nomenclature of Finishes and Explanation of Finish Symbols, see page 609.

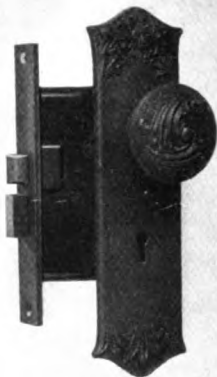

P3918 LOCK



I442 LOCK



I440 LOCK



P2530 LOCK.

Lock-sets for Corridor, Room and Closet Doors.  
Cuts  $\frac{1}{4}$  Size.

## Lock-sets for Corridor, Room and Closet Doors.

TRIM: Cluny Design.

Cast Bronze, Old Copper Finish (CX22).\*

Illustrated on opposite page.

### 4 1/2 Inch Locks.

P3918 Lock (p. 638); Trim: pair No. 56 Knobs (p. 734)  
and two Escutcheon Plates, 8 1/2 X 2 1/2 inches (p. 734).  
Prices: Lock P3918, \$2.65. Trim, \$8.00. . . . Set, \$10.65  
Add for 3 Tumbler lock P3918 3/4 (p. 638) 35 cents.

### 5 Inch Locks.

WITH TWO BOLTS.

1442 Lock (p. 639); Trim: pair No. 56 Knobs (p. 734)  
and two Escutcheon Plates, 8 1/2 X 2 1/2 inches (p. 734).  
Prices: Lock 1442, \$5.50. Trim, \$8.00. . . . Set, \$13.50

1440 Lock (p. 639); Trim: pair No. 56 Knobs (p. 734)  
and two Escutcheon Plates, 8 1/2 X 2 1/2 inches (p. 734).  
Prices: Lock 1440, \$4.75 Trim, \$8.00. . . . Set, \$12.75

P2530 Lock (p. 638); Trim: pair No. 56 Knobs (p. 734)  
and two Escutcheon Plates, 8 1/2 X 2 1/2 inches (p. 734).  
Prices: Lock P2530, \$4.20. Trim, \$8.00. . . . Set, \$12.20

### Above Locks (in sets) with Trim of Other Designs.

Lock trim in Ornamental Designs is shown on pages 235 to 581. For index by Schools see page 236, and for index alphabetically arranged see page 244. For method of pricing see page 33.

Example: If P3918 lock is wanted with Chambord trim in same finish, increase price for Cluny trim given above, by using the multiplier for Chambord, viz: 3.7 (page 437). This gives the value of Chambord trim as \$29.60, to which add value of lock as above, \$2.65, making value of lock-set in Chambord design, \$32.25.

If the trim is different on the opposite side of door, ascertain value of complete trim in each design; add these together and take one-half of their sum. Adding this to the value of the lock will give the value of the lock-set with mixed trim.

For above Locks associated with Plain Trim see page 691; and for lock-sets with Glass Knobs see pages 736 and 737.

In Specifying: Give lock number, name of design and finish name or symbol, thus: P3918, Cluny; CX22.

\*For article on "Metals and Finishes" see page 595, and for Nomenclature of Finishes and Explanation of Finish Symbols see page 609.

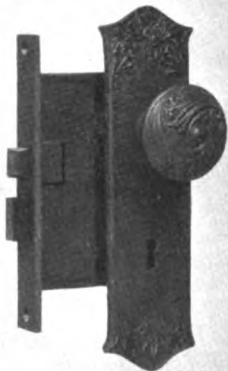

P4918 LOCK



1402

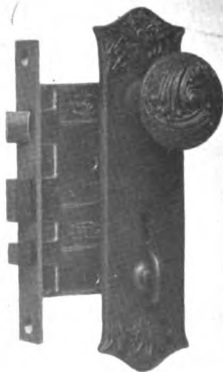

P2535 LOCK



P5918 1/2 L

Lock-sets for Corridor, Room and Closet Doors  
Cuts  $\frac{1}{4}$  Size.

## Lock-sets for Corridor, Room and Closet Doors.

TRIM : Cluny Design.

Cast Bronze, Old Copper Finish (CX22).\*

Illustrated on opposite page

## 5 Inch Locks—Continued.

WITH TWO BOLTS.

- P4918 Lock (p. 638); Trim : pair No. 56 Knobs (p. 734)  
and two Escutcheon Plates,  $8\frac{1}{2} \times 2\frac{1}{2}$  inches (p. 734)  
Prices : Lock P4918, \$3.85 Trim, \$8.00. . . Set, \$11.85  
Add for 3 Tumbler lock P4918 $\frac{3}{4}$  (p. 638) 35 cents.

WITH THREE BOLTS.

- 1402 Lock (p. 641); Trim : pair No. 56 Knobs (p. 734)  
and two Escutcheon Plates, one with Thumb-knob,  
 $8\frac{1}{2} \times 2\frac{1}{2}$  inches (p. 734)  
Prices : Lock 1402, \$4.75. Trim, \$8.80. . . Set, \$13.55
- P2535 Lock (p. 641); Trim : pair No. 56 Knobs (p. 734)  
and two Escutcheon Plates, one with Thumb-knob,  
 $8\frac{1}{2} \times 2\frac{1}{2}$  inches (p. 734)  
Prices : Lock P2535, \$4.50. Trim, \$8.80. . . Set, \$13.30
- P5918 $\frac{1}{2}$  Lock (p. 640); Trim : pair No. 56 Knobs (p. 734)  
and two Escutcheon Plates, one with Thumb-knob,  
 $8\frac{1}{2} \times 2\frac{1}{2}$  inches (p. 734)  
Prices : Lock P5918 $\frac{1}{2}$ , \$4.10. Trim, \$8.80. . . Set, \$12.90  
Add for 3 Tumbler lock P5918 $\frac{3}{4}$  (p. 640) 35 cents.

## Above Locks (in sets) with Trim of Other Designs.

Lock trim in Ornamental Designs is shown on pages 235 to 581. For index by Schools see page 236 and for index alphabetically arranged see page 244. For method of pricing see page 33.

Example : If P4918 lock is wanted with Chambord trim in same finish, increase price for Cluny trim given above, by using the multiplier for Chambord, viz : 3.7 (page 437). This gives the value of Chambord trim as \$29.60, to which add value of lock as above, \$3.85, making value of lock-set in Chambord design, \$33.45.

If the trim is different on the opposite side of door, ascertain value of complete trim in each design; add these together and take one-half of their sum. Adding this to the value of the lock will give the value of the lock-set with mixed trim.

For above Locks associated with Plain Trim see page 693; and for lock-sets with Glass Knobs see pages 736 and 737.

*In Specifying :* Give lock number, name of design and finish name or symbol, thus : P4918, Cluny; CX22.

\* For article on "Metals and Finishes" see page 595, and for Nomenclature of Finishes, and Explanation of Finish Symbols, see page 609.

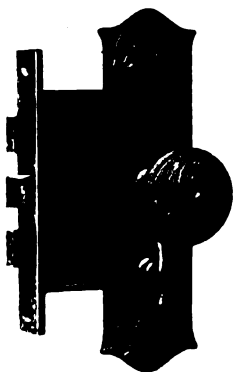

1504 LOCK



1505 LOCK

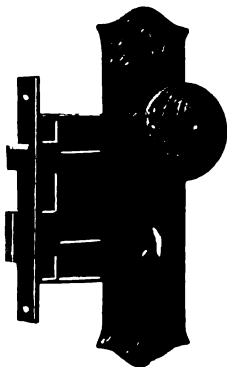

P 2400 LOCK



P 2405 LOCK

Lock-sets for Communicating Doors.  
Cuts  $\frac{1}{4}$  Size.

## Lock-sets for Communicating Doors.

TRIM: Cluny Design.

Cast Bronze, Old Copper Finish (CX22).\*

Illustrated on opposite page.

- P2400 Lock** (p. 626); Trim: pair No. 56 Knobs (p. 734) and two Escutcheon Plates with Thumb-knobs,  $8\frac{1}{2} \times 2\frac{1}{2}$  inches (p. 734).  
 Prices: Lock P2400, \$3.30. Trim, \$9.60. . . . Set, \$12.90
- P2405 Lock** (p. 625); Trim: pair No. 56 Knobs (p. 734) and two Escutcheon Plates, one with Thumb-knob,  $8\frac{1}{2} \times 2\frac{1}{2}$  inches (p. 734).  
 Prices: Lock P2405, \$2.40. Trim, \$8.80. . . . Set, \$11.20
- 1504 Lock** (p. 626); Trim: pair No. 56 Knobs (p. 734) and two Escutcheon Plates with Thumb-knobs,  $8\frac{1}{2} \times 2\frac{1}{2}$  inches (p. 734).  
 Prices: Lock 1504, \$3.30. Trim, \$9.60. . . . Set, \$12.90
- 1505 Lock** (p. 625); Trim: pair No. 56 Knobs (p. 734) and two Escutcheon Plates, one with Thumb-knob,  $8\frac{1}{2} \times 2\frac{1}{2}$  inches (p. 734).  
 Prices: Lock 1505, \$2.65. Trim, \$8.80. . . . Set, \$11.45

### Above Locks (in sets) with Trim of Other Designs.

Lock trim in Ornamental Designs is shown on pages 235 to 581. For index by Schools see page 236, and for index alphabetically arranged see page 244. For method of pricing see page 33.

**Example:** If P2400 lock is wanted with Chambord trim in same finish, increase price for Cluny trim given above, by using the multiplier for Chambord, viz: 3.7 (page 437). This gives the value of Chambord trim as \$35.50, to which add value of lock as above, \$3.30, making value of lock-set in Chambord design, \$38.80.

If the trim is different on the opposite side of door, ascertain value of complete trim in each design; add these together and take one-half of their sum. Adding this to the value of the lock will give the value of the lock-set with mixed trim.

For above Locks associated with Plain Trim see page 695; and for lock-sets with Glass Knobs see pages 736 and 737.

**In Specifying:** Give lock number, name of design and finish name or symbol, thus: P2400, Cluny; CX22.

\*For article on "Metals and Finishes" see page 595, and for Nomenclature of Finishes and Explanation of Finish Symbols see page 609.





1706 LOCK



P 3936 LOCK

Lock-sets for Sliding Doors.  
Cuts  $\frac{1}{4}$  Size.

## Lock-sets for Sliding Doors.

TRIM: Cluny Design.

Cast Bronze, Old Copper Finish (CX22).\*

Illustrated on opposite page.

- 1706 $\frac{1}{2}$  Lock (p. 650); Flat Front, for Single Doors; Trim:  
Two Cup Escutcheons, 8 $\frac{1}{2}$  × 2 $\frac{7}{8}$  inches (p. 734).  
Prices: Lock 1706 $\frac{1}{2}$ , \$6.20. Trim, \$6.00. . . Set, \$12.20
- 1706 Lock (p. 650); Flat Front, for Double Doors; Trim:  
Four Cup Escutcheons, 8 $\frac{1}{2}$  × 2 $\frac{7}{8}$  inches (p. 734).  
Prices: Lock 1706, \$8.40. Trim, \$12.00. . . Set, \$20.40
- 1726 Lock (p. 650); Astragal Front, for Double Doors; Trim:  
Four Cup Escutcheons, 8 $\frac{1}{2}$  × 2 $\frac{7}{8}$  inches (p. 734).  
Prices: Lock 1726, \$10.50. Trim, \$12.00. . . Set, \$22.50
- P3912 $\frac{1}{2}$  Lock (p. 650); Flat Front, for Single Doors; Trim:  
Two Cup Escutcheons, 8 $\frac{1}{2}$  × 2 $\frac{7}{8}$  inches (p. 734).  
Prices: Lock P3912 $\frac{1}{2}$ , \$2.55. Trim, \$6.00. . . Set, \$8.55
- P3924 $\frac{1}{2}$  Lock (p. 650); Flat Front, for Double Doors; Trim:  
Four Cup Escutcheons, 8 $\frac{1}{2}$  × 2 $\frac{7}{8}$  inches (p. 734).  
Prices: Lock P3924 $\frac{1}{2}$ , \$3.45. Trim, \$12.00. . . Set, \$15.45
- P3936 $\frac{1}{2}$  Lock (p. 650); Astragal Front, for Double Doors; Trim:  
Four Cup Escutcheons, 8 $\frac{1}{2}$  × 2 $\frac{7}{8}$  inches, (p. 734).  
Prices: Lock P3936 $\frac{1}{2}$ , \$4.75. Trim, \$12.00. . . Set, \$16.75

### Above Locks (in sets) with Trim of Other Designs.

Lock trim in Ornamental designs is shown on pages 235 to 581. For index by Schools see page 236, and for index alphabetically arranged see page 244. For method of pricing see page 33.

Example: If 1706 $\frac{1}{2}$  lock is wanted with Chambord trim in same finish, increase price for Cluny trim given above, by using the multiplier for Chambord viz: 3.7 (page 437). This gives the value of Chambord trim as \$22.20, to which add value of lock as above, \$6.20, making value of lock-set in Chambord design, \$28.40.

For above Locks associated with Plain Trim see page 697; and for full line of Ornamental Cup Escutcheons see pages 000 to 000.

*In Specifying* : Give lock number, name of design and finish name or symbol, thus: 1706, Cluny; CX22.

\*For article on "Metals and Finishes" see page 595, and for Nomenclature of Finishes, and Explanation of Finish Symbols, see page 609.



1685 LOCK



1680 LOCK

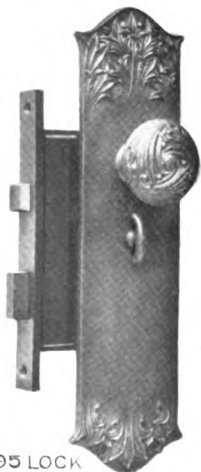

1695 LOCK



P1793 LOCK

Lock-sets for Hotel Doors.  
Cuts  $\frac{1}{4}$  Size.

## Lock-sets for Hotel Doors.

TRIM: Cluny Design.

Cast Bronze, Old Copper Finish (CX22).\*

Illustrated on opposite page.

1793 Lock (p. 641); Trim: pair No. 56 Knobs (p. 734) and two Escutcheon Plates,  $8\frac{1}{2} \times 2\frac{1}{2}$  inches (p. 734).  
Prices: Lock P1793, \$4.25. Trim, \$8.00. . . . Set, \$12.25

1680 Lock (p. 642); Trim: pair No. 56 Knobs (p. 734) and two Escutcheon plates, one with Thumb-knob,  $8\frac{1}{2} \times 2\frac{1}{2}$  inches (p. 734).  
Prices: Lock 1680, \$8.25. Trim, \$8.80. . . . Set, \$17.05

1695 Lock (p. 644); Trim: pair No. 56 Knobs (p. 734) and two Escutcheon Plates, one with Thumb-knob,  $10 \times 2\frac{1}{2}$  inches (p. 734).  
Prices: Lock 1695, \$11.00. Trim, \$10.00. . . . Set, \$21.00

1685 Lock (p. 643); Trim: pair No. 56 Knobs (p. 734) and two Escutcheons,  $10 \times 2\frac{1}{2}$  inches (p. 734).  
Prices: Lock 1685, \$12.00. Trim, \$9.20. . . . Set, \$21.20

## Above Locks (in sets) with Trim of Other Designs.

Lock trim in Ornamental Designs is shown on pages 235 to 581. For index by Schools see page 236, and for index alphabetically arranged see page 244. For method of pricing see page 33.

Example: If P1793 lock is wanted with Chambord trim in same finish, increase price for Cluny trim given above, by using the multiplier for Chambord, viz: 3.7 (page 437). This gives the value of Chambord trim as \$29.60, to which add value of lock as above, \$4.25, making value of lockset in Chambord design, \$33.85.

If the trim is different on the opposite side of door, ascertain value of complete trim in each design; add these together and take one-half of their sum. Adding this to the value of the lock will give the value of the lock-set with mixed trim.

For above Locks associated with Plain Trim see page 699; and for lock-sets with Glass Knobs see pages 736 and 737.

*In Specifying:* Give lock number, name of design, and finish name or symbol, thus: P1793, Cluny; CX22.

\*For article on "Metals and Finishes" see page 595, and for Nomenclature of Finishes and Explanation of Finish Symbols see page 609.



614 LOCK



770

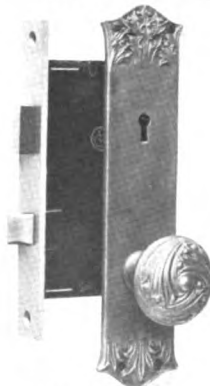

1614 LOCK



656 H

Lock-sets for Office Doors  
Cuts  $\frac{1}{4}$  Size.

## Lock-sets for Office Doors.

TRIM: Cluny Design.

Cast Bronze, Old Copper Finish (CX22).\*

Illustrated on opposite page.

770 Lock (p. 647); Trim: pair No. 56 Knobs (p. 734) and two Escutcheon Plates, one with Thumb-knob,  $8\frac{1}{2} \times 2\frac{1}{2}$  inches (p. 734).

Prices: Lock 770, \$12.15. Trim, \$8.80. . . . Set, \$20.95

656H Lock (p. 646); Trim: pair No. 56 Knobs (p. 734) and two Escutcheon Plates,  $8\frac{1}{2} \times 2\frac{1}{2}$  inches (p. 734).

Prices: Lock 656H, \$15.65. Trim, \$8.00. . . . Set, \$23.65

614 Lock (p. 645); Trim: pair No. 56 Knobs (p. 734) and two Escutcheon Plates,  $8\frac{1}{2} \times 2\frac{1}{2}$  inches (p. 734).

Prices: Lock 614, \$15.80. Trim, \$8.00. . . . Set, \$23.80

1614 Lock (p. 645); Trim: pair No. 56 Knobs (p. 734) and two Escutcheon Plates,  $8\frac{1}{2} \times 2\frac{1}{2}$  inches (p. 734).

Prices: Lock 1614, \$8.80. Trim, \$8.00. . . . Set, \$16.80

### Above Locks (in sets) with Trim of Other Designs.

Lock trim in Ornamental Designs is shown on pages 235 to 581. For index by Schools see page 236, and for index alphabetically arranged see page 244. For method of pricing see page 33.

Example: If 770 lock is wanted with Chambord trim in same finish, increase price for Cluny trim given above, by using the multiplier for Chambord, viz: 3.7 (page 437.) This gives the value of Chambord trim as \$32.55, to which add value of lock as above, \$12.15, making value of lock-set in Chambord design, \$44.70.

If the trim is different on the opposite side of door, ascertain value of complete trim in each design; add these together and take one-half of their sum. Adding this to the value of the lock will give the value of the lock-set with mixed trim.

For above Locks associated with Plain Trim see page 701; and for lock-sets with Glass Knobs see pages 736 and 737.

*In Specifying:* Give lock number, name of design and finish name or symbol, thus: 614, Cluny; CX22.

\*For article on "Metals and Finishes" see page 595, and for Nomenclature of Finishes and Explanation of Finish Symbols, see page 609.

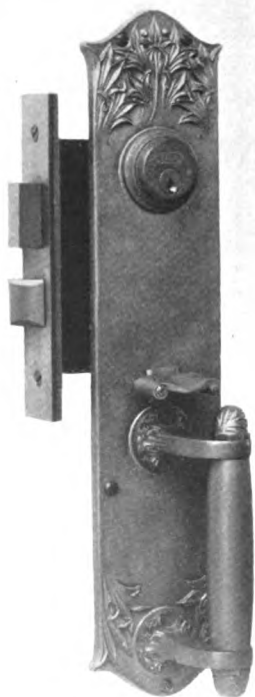

414 LOCK

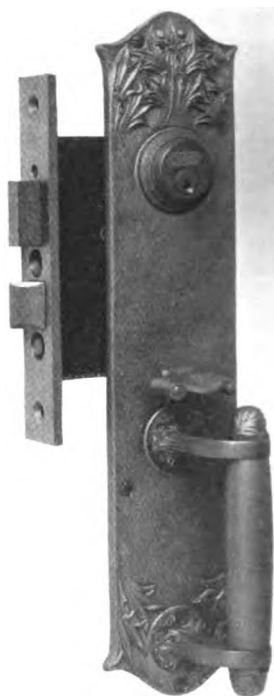

732 LOCK

### Lock-sets for Store Doors.

TRIM:—Cluny Design, Cast Bronze, Old Copper Finish (CX22).

- 414 Lock (p. 665); Trim, pair 314 Handles, 15×3½ ins., (p. 735).  
 Prices: Lock 414, \$13.20. Trim, \$17.00. . . . Set, \$30.20
- 732 Lock (p. 666); Trim: pair 314 Handles, 15×3½ ins. (p. 735).  
 Prices: Lock 732, \$15.80. Trim, \$17.00. . . . Set, \$32.80

For Plain and Ornamental Lock-sets see pages 738 to 760.

*In Specifying:* Give lock number, name of design and finish name or symbol, thus: 414, Cluny; CX22.

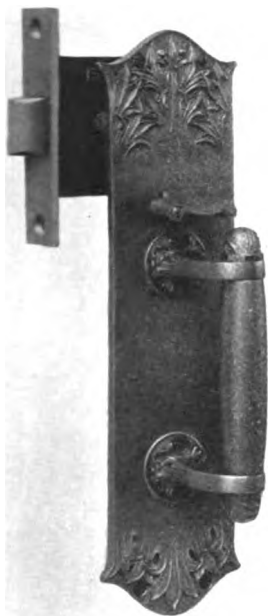

1122 LOCK

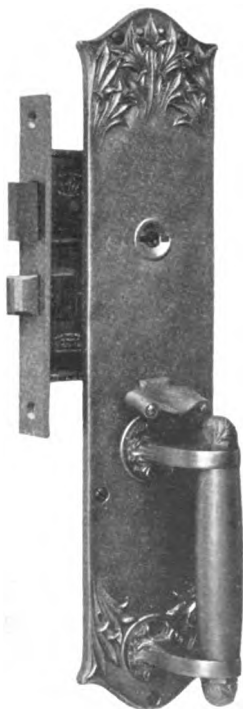

P 2533 LOCK

## Lock-sets for Store Doors.

**TRIM:**—Cluny Design, Cast Bronze, Old Copper Finish (CX22).

1122 Latch (p. 664); Trim: pair 315 Handles,  $12\frac{5}{8} \times 3\frac{3}{8}$  ins. (p. 735).

Prices: Lock 1122, \$7.65. Trim, \$15.50. . . . Set, \$23.15

P2533 Lock (p. 664); Trim: pair 310 Handles,  $15 \times 3\frac{1}{2}$  ins. (p. 735).

Prices: Lock P2533, \$5.55. Trim, \$17.00. . . . Set, \$22.55

For Plain and Ornamental Lock-sets, see pages 738 to 760.

*In Specifying:* Give lock number, name of design and finish name or symbol, thus: 1122, Cluny; CX22.



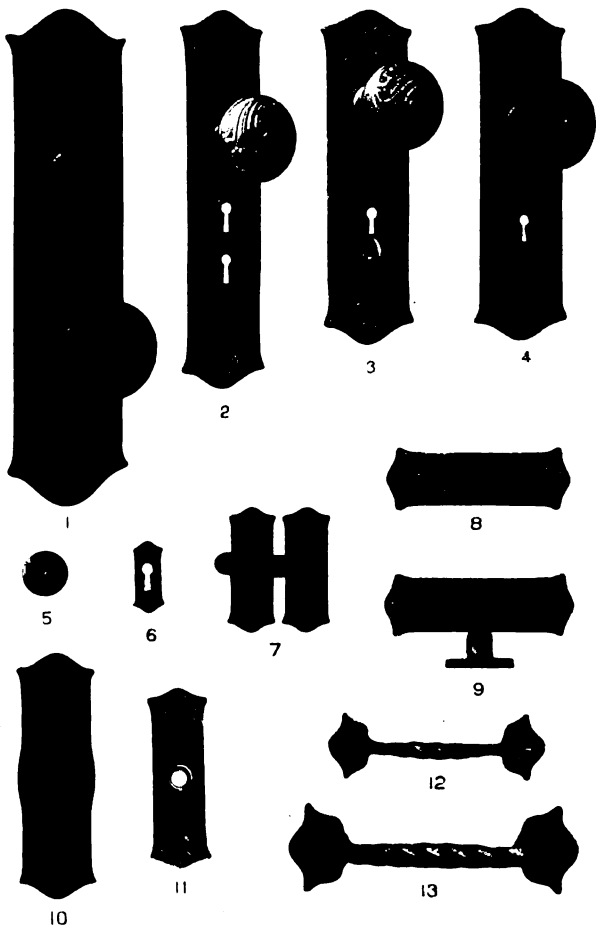

Cluny Design, Romanesque School.  
Cuts  $\frac{1}{4}$  Size.



14



15



16



17



18



19



20



21



22

Cluny Design, Romanesque School.  
Cuts  $\frac{1}{4}$  Size.

## Ornamental Hardware.

## Cluny Design.

Prices in Bronze, Old Copper Finish (CX22).

Name.	No.	Size in Inches.	Fig.	Page.	Group.*	Each
Bar Sash Lift, . . .	1360	2¼ × 7¼	13	732	...	\$ 2.00
“ “ “ . . .	1362	1⅝ × 5½	12	“	..	1.00
Bell Pull, . . . .	1200	6 × 2	21	733	..	4.40
Bolt, . . . . .		See Extension Bolt				
Cup Escutcheons, . .	854	8½ × 2⅞	22	“	904	6.00†
Door Knobs, . . . .	55	2½ × 2½	1	732	...	4.00†
“ “ . . . . .	55½	2½ × 2¼	1 & 2	“	...	3.60†
“ “ . . . . .	56	2¼ × 2¼	2	“	...	3.20†
Door Pull, . . . . .	45	12¾ × 3⅜	15	733	823	6.60
“ “ . . . . .	47	12¾ × 3⅜	†	“	“	8.20
Drawer Knob, . . .	1065	1⅞	5	732	940	1.50
Drawer Pull, Drop, .	1099	1½ × 5⅞	18	921	925	2.10
“ “ “ . . . . .	1099	2 × 6	20	“	“	2.10
Escutcheon Plates, .		5 × ⅞	‡	...	...	.90§
“ “ . . . . .		5¼ × 1½	‡	...	...	.90§
“ “ . . . . .		7¼ × 2	‡	...	...	1.50§
“ “ . . . . .		8½ × 2½	4	732	...	2.40§
“ “ . . . . .		10 × 2½	2	...	...	3.00§
“ “ . . . . .		12⅝ × 3⅜	1	...	...	4.60§
Extension Bolts, . . .	788	6⅞ × 2	16	733	893	3.40
Flush Sash Lift, . . .	1344	1⅝ × 4½	8	732	916	.90
“ “ “ . . . . .	1344 L	1⅝ × 4½	9	“	“	2.20
“ “ “ . . . . .	1349	2 × 5⅞	‡	...	“	1.10
Hinge Plate, Angle, .	TBI	5¼ × 5¼ × 1½	‡	...	847	2.65
“ “ “ . . . . .	TBII	9¼ × 5¼ × 1½	8	...	“	4.85
“ “ “ . . . . .	TBIII	15 × 12 × 3½	‡	...	“	14.60
“ “ “ . . . . .	TBIV	18 × 14¾ × 3⅜	‡	...	“	18.75
“ “ “ . . . . .	TBV	15⅞ × 12½ × 4⅞	‡	...	“	16.80
“ “ “ . . . . .	TBVI	15⅜ × 15⅜ × 3¾	‡	...	“	17.60
“ “ “ . . . . .	TBVII	7⅞ × 5⅞ × 1½	3	...	“	2.75

\* Groups of Plain and Ornamental Hardware are shown in Part VII., page 821. Page reference shows where similar pieces in other designs may be seen.

† Per pair. § Add for Thumb-pieces 80 cents each. ‡ Not illustrated.

## Ornamental Hardware—Continued.

Name.	No.	Size. in Inches.	Fig.	Page.	Group.*	Each.
Hinge Plate, Middle,	MI	9 × 1½	5	...	847	\$ 4.75
" " "	MII	15 × 3½	†	...	"	11.35
" " "	MIII	15¾ × 4⅛	†	...	"	12.80
Key Plate, . . .	802	1½ × 3¼	†	...	...	.45
" " . . .	806	3⅛ × 1½	†	...	...	.45
" " . . .	803	1¾ × ¾	6	732	...	.45
" " . . .	804	1½ × 3¼	†	...	...	.45
" " . . .	805	3¼ × 1½	†	...	...	.45
Knobs, Door, . . .		See Door Knobs				
" Drawer, . . .		" Drawer "				
" Shutter, . . .		" Shutter "				
Letter Drop Plate, .	1506	2½ × 8½	20	733	917	2.85
Letter Drop Plate and Back, . . . .	1506½	2½ × 8½	20	"	"	4.30
Letter Drop Plate and Hood, . . . .	1507	2¼ × 7¾	19	"	"	5.70
Push Button, . . .	1413	4½ × 1½	11	732	894	2.65
" " . . .	1415	6 × 2	10	"	"	3.25
Push Plate, . . .	1730	8½ × 2½	†	...	923	2.40
" " . . .	1730	12⅝ × 3⅜	†	...	"	4.60
" " . . .	1730	14¾ × 3¼	17	733	"	5.15
" " . . .	1730	18 × 3¾	†	...	"	7.35
" " . . .	1730	20⅛ × 4⅛	†	...	"	8.45
Sash Socket, . . .	1351	1½ × 3¼	18	733	"	1.10
Shutter Bar, . . .	1382	3¼ × 1¼	7	732	922	1.75
Shutter Knob, . . .	1321	1⅛	5	"	"	.65
Store Door Handles, .	310	15 × 3½	P2533	731	739	17.00†
" " " . . .	314	15 × 3½	414	730	"	17.00†
" " " . . .	315	12⅝ × 3⅜	1122	731	"	15.50†
" " " . . .	332	18 × 3¾	†	...	"	23.00†
T Handle Plate, . . .	9	4 × 1	†	...	...	.60
Thumb Knob, . . .	2115	1¾ × 1¾	†	...	940	1.85

\* Groups of Plain and Ornamental Hardware are shown in Part VII., page 821. Page reference shows where similar pieces in other designs may be seen.

† Per pair. ‡ Not Illustrated.



1

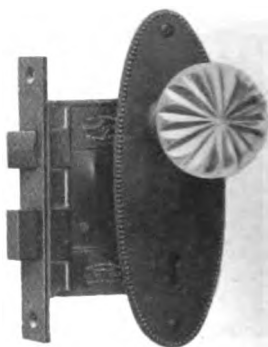

2

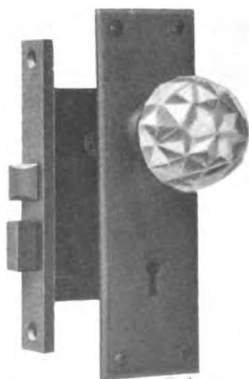

3

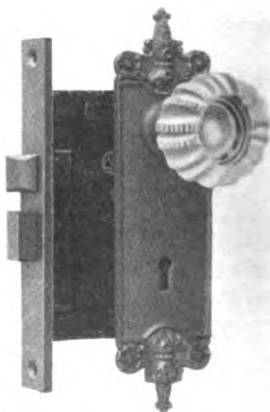

4

**Lock-sets with Glass Knobs**

With Chester (Fig. 1), Bristol (Fig. 2), Yorktown (Fig. 3) and Ambois (Fig. 4) Designs.

For full line of Glass Knobs see page 944.

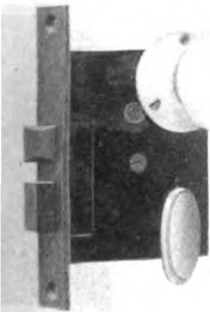

1

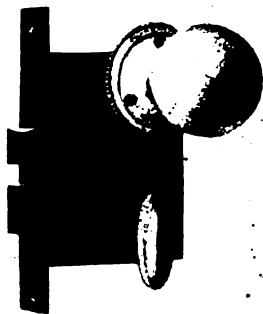

2

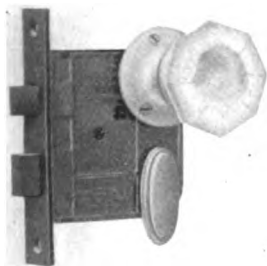

3

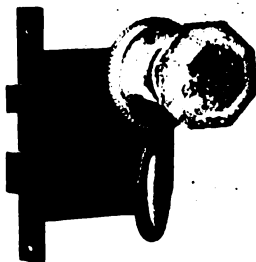

4

Typical Glass Knob Lock-sets.

With roses and Key Plates, Plain (Figs. 1 and 3) and Beaded (Figs. 2 and 4). For all line of Glass Knobs see page 944.

Cuts about  $\frac{1}{4}$  Size.



1



2



3



4



5



6



7



8



9



10

Plain Store Door Handles.  
About  $\frac{1}{8}$  Size.

## Lock-sets for Store Doors.

TRIM : Illustrated on opposite page.

Plain Bronze Buffed (BZ10) and Bower-Barffed Iron (FX80).\*

Handles.	Fig.	Length.	Per Pair.	Finish.*	Lock.	Each.	Per set †
332	1	15 ins.	\$12.20	BZ10	432	\$13.20	\$25.40
"	"	"	9.25	FX80	"	"	22.45
332B	2	"	13.40	BZ10	"	"	26.60
"	"	"	10.00	FX80	"	"	23.20
332S	3	"	21.00	BZ10	"	"	34.20
"	"	"	15.80	FX80	"	"	29.00
333	4	"	15.80	BZ10	"	"	29.00
"	"	"	12.00	FX80	"	"	25.20
334	5	"	13.50	BZ10	"	"	26.70
"	"	"	10.00	FX80	"	"	23.20
3314B	6	13 1/4 "	12.50	BZ10	"	"	25.70
"	"	"	9.50	FX80	"	"	22.70
3314	7	"	11.20	BZ10	"	"	24.20
"	"	"	8.50	FX80	"	"	21.70
314B	8	13 1/2 "	12.20	BZ10	"	"	25.40
"	"	"	9.20	FX80	"	"	22.40
W06314	9	13 "	8.80	BZ10	"	"	22.00
"	"	"	7.50	FX80	"	"	20.70
W06314B	10	"	10.20	BZ10	"	"	23.40
"	"	"	8.80	FX80	"	"	22.00

\*For article on "Metals and Finishes" see page 595, and for Nomenclature of Finishes and Explanation of Finish Symbols see page 609.

† Prices given are for Handles associated with the 432 (p. 665) Flat Front Lock. For Lock with Rabbeted Front 432R (p. 665) add \$4.00. For other Store Door Locks see pages 664 to 666.





11



12



13



14



15



16



17



18



19



20

Plain Store Door Handles.

About  $\frac{1}{2}$  Size.

## Lock-sets for Store Doors.

TRIM: Illustrated on opposite page.

Plain Bronze Buffed (BZ10) Old Copper, Sanded (CX22) and  
Bower-Barfied Iron (FX80).\*

Handles.	Fig.	Length.	Per Pair.	Finish.*	Lock.	Each.	Per Set.†
314	11	13 1/2 ins.	\$10.90	BZ10	432	\$13.20	\$24.10
"	"	"	8.20	FX80	"	"	21.40
318	12	"	10.90	BZ10	"	"	24.10
"	"	"	8.20	FX80	"	"	21.40
318B	13	"	12.20	BZ10	"	"	25.40
"	"	"	9.20	FX80	"	"	22.40
310	14	11 1/2 "	7.85	BZ10	P2533	5.55	13.40
"	"	"	9.35	CX22	"	"	14.90
310B	15	"	9.10	BZ10	"	"	14.65
"	"	"	10.70	CX22	"	"	16.25
W06310B	17	13 1/4 "	9.05	BZ10	"	"	14.60
"	"	"	10.65	CX22	"	"	16.20
W06310	18	"	7.75	BZ10	"	"	13.30
"	"	"	9.30	CX22	"	"	14.85
3310B	19	"	12.55	BZ10	"	"	18.10
"	"	"	9.45	FX80	"	"	15.00
3310	20	"	11.20	BZ10	"	"	16.75
"	"	"	8.45	FX80	"	"	14.00

\* For article on "Metals and Finishes" see page 595, and for Nomenclature of Finishes and Explanation of Finish Symbols see page 609.

† Prices given are for Handles associated with 432 (p. 665) and P2533 (p. 664) Flat Front Locks. For Locks with Rabbeted Fronts add as follows: For 432R (p. 665) add \$4.00. For P2533R (p. 664) add \$2.65. For other Store Door Locks see pages 664 to 666.



21



22



23



24



25



26



27



28



29

Plain Store Door Handles.  
Cuts about  $\frac{1}{16}$  Size.

## Lock-sets for Store Doors.

TRIM : Illustrated on opposite page.

Plain Bronze Buffed (BZ10) and Bower-Barffed Iron (FX80).\*

Handles.	Fig.	Length.	Per Pair.	Finish.*	Lock.	Each.	Per Set.†
166314	21	20 ins.	\$23.65	FX80	432	\$13.20	\$36.85
"	"	"	13.20	Japanned	"	"	26.40
320	22	18 ins.	17.60	BZ10	454	46.20	63.80
2320	"	"	13.20	FX80	"	"	59.40
714	23	15 ins.	13.50	BZ10	432	13.20	26.70
2714	"	"	10.10	FX80	"	"	23.30
614	24	16 ins.	16.65	BZ10	"	"	29.85
2614	"	"	12.50	FX80	"	"	25.70
315	25	9 ins.	8.60	BZ10	1122	7.65	16.25
"	"	"	4.50	FX80	"	"	12.15
315B	26	"	9.90	BZ10	"	"	17.55
"	"	"	5.50	FX80	"	"	13.15
315S	27	"	13.00	BZ10	"	"	26.65
"	"	"	9.75	FX80	"	"	17.35
2025	28	9½ ins.	5.75	BZ10	P2025	2.25	8.00
"	"	"	4.25	FX80	"	"	6.50
2020 Latch.	29	"	...	BZ10	...	...	4.40
"	"	"	...	FX80	...	...	4.40

\*For article on "Metals and Finishes" see page 595, and for Nomenclature of Finishes and Explanation of Finish Symbols see page 609.

†Prices given are for Handle; associated with 432 (p. 665), 454 (p. 666), 1122 (p. 664), and P2025 (p. 665), Flat Front Locks. For Locks with Rabbeted Fronts add as follows: For 432R (p. 665) add \$4.00; for 454R (p. 666) add \$4.00; for P2025R (p. 665) add \$1.25. For other Store Door Locks see pages 664 to 666.



ABBOTTSFORD



ALAMS



ALBI



ALENCON



ALSATIAN



AM-USE



ANTWERP



ANONA



ARLINGTON



ARNO

## Ornamental Store Door Handles.

Cuts about  $\frac{1}{8}$  Size

Digitized by Google

## Lock-sets for Store Doors.

TRIM : Illustrated on opposite page.

Handles in two appropriate finishes as given below.\*

Handles.	Length.	Per Pair.	Finish.*	Lock.	Each.	Per Set.†
Abbottsford, . . .	20 ins.	\$64.00	SY55	432	\$13.20	\$77.20
Adams, . . .	18 $\frac{3}{4}$ "	47.00	FX80	"	"	60.20
	"	62.70	BZ10	"	"	75.90
Albi, . . .	15 "	18.80	CX22	"	"	32.00
	"	14.00	FX80	"	"	27.20
Alencon, . . .	17 $\frac{1}{4}$ "	22.20	AY22	"	"	35.40
	"	32.55	SX52	"	"	45.75
Alsatian (Iron),	20 $\frac{1}{4}$ "	5.75	FCZ17	P2533	5.55	11.30
Amboise, . . .	18 "	34.80	CX22	432	13.20	48.00
	"	14.30	FX80	"	"	27.50
Antwerp, . . .	19 $\frac{1}{2}$ "	40.00	CX22	"	"	53.20
	"	66.00	SX52	"	"	79.20
Ancona, . . .	23 $\frac{3}{4}$ "	72.80	CX22	"	"	86.00
	"	42.55	FX80	"	"	55.75

Arcadian, illustrated and priced on pages 758 and 759.

Arlington, . . .	18 $\frac{1}{4}$ ins.	18.80	AZ10	432	"	32.00
	"	19.80	AY22	"	"	33.00
Arno (Iron), . . .	17 $\frac{1}{2}$ "	5.75	FCZ17	P2533	5.55	11.30

Arno, additional handle illustrated and priced on pages 758 and 759.

\* For article on "Metals and Finishes" see page 595, and for Nomenclature of Finishes and Explanation of Finish Symbols see page 60.

† Prices given are for Handles associated with 432 (p. 665) and P2533 (p. 664) Flat Front Locks. For Locks with Rabbeted Fronts add as follows: For 432R (p. 665), add \$4.00; for P2533R (p. 664), add \$2.65. For other Store Door Locks see pages 664 to 666.



AUSTRLITZ



AUVERGNE



BEAUVAIS



BERGAMO



BONN



BO-DEAUX



BREBANT



BRUNSWICK



CUNY



GAMBIA

Ornamental Store Door Handles.

Cuts about  $\frac{1}{4}$  Size.

## Lock-sets for Store Doors.

TRIM : Illustrated on opposite page.

Handles in two appropriate finishes as given below.\*

2 Handles.	Length.	Per Pair.	Finish.*	Lock.	Each.	Per Set.†
Austerlitz, . . .	19 <sup>1</sup> / <sub>8</sub> ins.	\$17.60	AZ15	432	\$13.20	\$30.80
	"	30.80	SX52	"	"	44.00
Auvergne, . . .	15 <sup>1</sup> / <sub>4</sub> "	14.30	FX80	"	"	27.50
	"	20.60	CX22	"	"	33.80
Beauvais, . . .	22 "	39.60	AZ10	"	"	52.80
	"	30.90	FX80	"	"	44.10
Bergamo, . . .	"	50.20	CX22	"	"	63.40
	"	59.80	SY55	"	"	73.00
Bonn, . . .	16 <sup>1</sup> / <sub>2</sub> "	18.60	FX80	"	"	31.80
	"	28.00	AX10	"	"	41.20
Bordeaux, . . .	20 "	39.60	AZ10	"	"	52.80
	"	19.80	FX80	"	"	33.00
Brabant, . . .	16 "	37.00	CX22	"	"	50.20
	"	50.20	BX67	"	"	63.40
Brunswick, . . .	"	31.80	BZ10	"	"	45.00
	"	33.00	CY22	"	"	46.20
Cluny, . . .	15 "	14.00	FX80	"	"	27.20
	"	17.00	CX22	"	"	30.20
Cambria, . . .	23 "	44.40	CY22	"	"	57.60
	"	57.60	SY52	"	"	70.80

\*For article on "Metals and Finishes" see page 595, and for Nomenclature of Finishes and Explanation of Finish Symbols see page 609.

†Prices given are for Handles associated with 432 (p. 665) Flat Front Lock. For Lock with Rabbeted Front 432R (p. 665) add \$4.00. For other Store Door Locks see pages 664 to 666.





CANTERBURY



CATANIA



CEVA



DRESDEN



FLORENCE



COLONNA



DURIO



DODONA

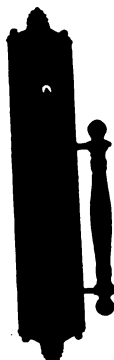

EPHESUS



FALSA

Ornamental Store Door Handles.  
Cuts about 1/8 Size.

## Lock-sets for Store Doors.

TRIM : Illustrated on opposite page.

Handles in two appropriate finishes as given below.\*

2 Handles.	Length.	Per Pair.	Finish.*	Lock.	Each.	Per Set.†
Canterbury, . . .	28 ins.	\$61.60	CX22	432	\$13.20	\$74.80
	"	73.70	SX52	"	"	86.90
Catania, . . .	28 3/4 "	68.20	CX22	"	"	81.40
	"	81.40	BX67	"	"	94.60
Ceva, . . .	24 "	67.00	CX22	"	"	80.20
	"	35.00	FX80	"	"	48.20
Colonna, . . .	8 1/2 "	15.50	BZ10	1122	7.65	22.15
	"	15.50	CY22	"	"	22.15
Dresden, . . .	20 3/4 "	32.20	CX22	432	13.20	46.40
	"	21.80	FX80	"	"	35.00
Douvaine, . . .	21 1/2 "	88.00	CX22	"	"	101.20
	"	101.00	SX52	"	"	114.20
Duro (Iron), . . .	14 "	5.45	FCX22	P2533	5.55	11.00
	"	5.95	FX80	"	"	11.50
Dodona, . . .	19 1/4 "	48.40	CX22	432	13.20	61.60
	"	61.60	BX67	"	"	74.80
Ephesus, . . .	17 1/2 "	35.00	CX22	"	"	48.20
	"	43.40	BX67	"	"	53.60
Fairfax, . . .	18 "	24.40	AZ10	"	"	37.60
	"	26.80	AY22	"	"	40.00

\* For article on "Metals and Finishes" see page 595, and for Nomenclature of Finishes, and Explanation of Finish Symbols, see page 609.

† Prices given are for Handles associated with 432 (p. 665), 1122 (p. 664) and P2533 (p. 664) Flat Front Locks. For Locks with Rabbeted Fronts add as follows: For 432R (p. 665) add \$4.00; for P2533R (p. 664) add \$2.65. For other Store Door Locks see pages 664 to 666.



FLORIAN 201



FLORIAN



FLORIAN



FLORIAN



FLORIAN



FLORIAN



FLORIAN



FLORIAN



FLORIAN

Ornamental Store Door Handles.

Cuts about  $\frac{1}{8}$  Size.

## Lock-sets for Store Doors.

TRIM : Illustrated on opposite page.

Handles in two appropriate finishes as given below.\*

2 Handles.	Length.	Per Pair.	Finish.*	Lock.	Each.	Per Set.†
Florensac, . . .	19 1/2 ins.	\$35.50	CX22	432	\$13.20	\$48.70
	"	45.20	SX52	"	"	58.40
Fleury, . . .	18 "	26.30	CX22	"	"	39.50
	"	31.80	SX52	"	"	45.00
Florian, . . .	13 "	7.70	BZ36	P2533	5.55	13.25
Florian, additional handle illustrated and priced on pages 758 and 759.						
Genoa, . . .	15 7/8 ins.	\$34.70	CX22	432	\$13.20	47.90
	"	15.80	FX80	"	"	29.00
Gardo, . . .	18 "	15.80	CX22	"	"	29.00
	"	33.00	SX52	"	"	46.20
Hingham, . . .	13 1/2 "	16.50	AY22	"	"	29.70
	"	12.40	FX80	"	"	25.60
Hondo, . . .	18 "	15.80	CX22	"	"	29.00
	"	33.00	SX52	"	"	46.20
Jena, . . .	21 3/4 "	47.50	CX22	"	"	60.70
	"	56.10	SY52	"	"	69.30
Kelp, . . .	20 1/4 "	23.10	FX80	"	"	36.30
	"	30.80	CX22	"	"	44.00
Largo, illustrated and priced on pages 758 and 759.						
Larissa, . . .	13 3/4 ins.	\$15.30	AY22	"	"	28.50
	"	10.80	FX80	"	"	24.00

\* For article on "Metals and Finishes" see page 595, and for Nomenclature of Finishes and Explanation of Finish Symbols see page 609.

† Prices given are for Handles associated with 432 (p. 665) and P2533 (p. 664) Flat Front Locks. For Locks with Rabbed Fronts add as follows: For 432R (p. 665) add \$4.00, for P2533R (p. 664) add \$2.65. For other Store Door Locks see pages 664 to 666.



Ornamental Store Door Handles.

Cuts about  $\frac{1}{8}$  Size.

## Lock-sets for Store Doors.

TRIM: Illustrated on opposite page.

Handles in two appropriate finishes as given below.\*

Handles.	Length.	Per Pair.	Finish.*	Lock.	Each.	Per Set.†
Libourne, . . .	20 $\frac{5}{8}$ ins.	\$44.10	CX22	432	\$13.20	\$47.30
	"	60.50	SY55	"	"	73.70
Lodi, . . .	20 $\frac{1}{2}$ "	35.50	CY22	"	"	48.70
	"	53.00	SY52	"	"	66.20
Lynn, . . .	13 $\frac{1}{2}$ "	16.50	BZ10	"	"	29.70
	"	10.00	FX80	"	"	23.20
Marathon, illustrated and priced on pages 758 and 759.						
Marengo, . . .	19 $\frac{1}{8}$ ins.	\$17.60	AZ15	432	"	30.80
	"	30.80	SX52	"	"	44.00
Marly, . . .	20 $\frac{1}{4}$ "	26.40	CX22	"	"	39.60
	"	19.80	FX80	"	"	33.00
Medici, . . .	20 $\frac{5}{8}$ "	33.80	FX80	"	"	47.00
	"	72.20	SX52	"	"	85.40
Milan, . . .	20 $\frac{1}{4}$ "	60.60	CY22	"	"	73.80
	"	68.10	SY55	"	"	92.40
Milo, . . .	21 $\frac{1}{2}$ "	36.30	CX22	"	"	49.50
	"	49.50	SX52	"	"	62.70
Miletus, . . .	20 $\frac{1}{4}$ "	49.80	CX22	"	"	63.00
	"	58.60	BX67	"	"	71.80
Monceaux, illustrated and priced on pages 758 and 759.						
Monaco (Iron), illustrated and priced on page 760.						
Nimes, . . .	15 $\frac{1}{4}$ ins.	\$44.00	FX80	432	"	57.20
	"	33.00	AZ10	"	"	46.20

\* For article on "Metals and Finishes" see page 595, and for Nomenclature of Finishes and Explanation of Finish Symbols see page 609.

† Prices given are for Handles associated with 432 (p. 665) Flat Front Lock. For Lock with Rabbeted Front 432R (p. 665) add \$4.00. For other Store Door Locks see pages 664 to 666.



P4



P 2535 t



Locks

## Lock-sets for Store Doors.

TRIM : Illustrated on opposite page.

Handles in two appropriate finishes as given below.\*

Handles.	Length.	Per Pair.	Finish.*	Lock.	Each.	Per Set.†
illustrated and priced on page 760.						
"	"	"	"	"	"	"
"	"	"	"	"	"	"
16 ins.		\$17.60	AZ10	432	\$13.20	30.80
"		13.20	FX80	"	"	26.40
20 "		29.80	FX80	"	"	43.00
"		39.60	CY22	"	"	52.80
15 1/2 "		14.00	FX80	"	"	27.20
"		19.80	CX22	"	"	33.00
17 3/4 "		59.65	CY22	"	"	72.85
"		68.20	SY52	"	"	81.40
30 1/8 "		100.10	CX22	"	"	113.30
"		75.10	FX80	"	"	88.30
15 1/4 "		14.50	FX80	"	"	27.70
"		27.00	AZ10	"	"	40.20
Illustrated and priced on page 760.						
16 1/8 ins.		\$19.80	AZ10	"	"	33.00
"		21.40	CX22	"	"	34.60
27 1/4 "		43.00	CX22	"	"	56.20
"		56.20	SX52	"	"	69.40
21 1/8 "		37.50	CX22	"	"	50.70
"		22.30	FX80	"	"	35.50
14 5/8 "		20.80	AZ10	"	"	34.00
"		14.10	FX80	"	"	27.30

\*For article on "Metals and Finishes" see page 595, and for Nomenclature of Finishes and Explanation of Finish Symbols see page 609.

†Prices given are for Handles associated with 432 (p. 665) Flat Front Lock. For Lock with Rabbeted Front 432R (p. 665) add \$4.00. For other Store Door Locks see pages 664 to 666.





PLYMOUTH



PARMA



REALMONT



RHODES



RIVOLI



ROANOK



SALEM



SEVRES



SENLIS



SPARTA

Ornamental Store Door Handles.

Cuts about 1/8 Size.

## Lock-sets for Store Doors.

TRIM : Illustrated on opposite page.

Handles in two appropriate finishes as given below.\*

2 Handles.	Le.ngth.	Per Pair.	Finish.*	Lock.	Each.	Per Set.†
Navarro, illustrated and priced on page 760.						
Nemours, " " " " " "						
Plymouth, . . . 16 ins.		\$17.60	AZ10	432	\$13.20	30.80
	"	13.20	FX80	"	"	26.40
Parma, . . . 20 "		29.80	FX80	"	"	43.00
	"	39.60	CY22	"	"	52.80
Realmont, . . . 15½ "		14.00	FX80	"	"	27.20
	"	19.80	CX22	"	"	33.00
Rhodes, . . . 17¾ "		59.65	CY22	"	"	72.85
	"	68.20	SY52	"	"	81.40
Rivoli, . . . 30 <sup>1</sup> / <sub>8</sub> "		100.10	CX22	"	"	113.30
	"	75.10	FX80	"	"	88.30
Roanoke, . . . 15¼ "		14.50	FX80	"	"	27.70
	"	27.00	AZ10	"	"	40.20
Rokeby, illustrated and priced on page 760.						
Salem, . . . 16 <sup>1</sup> / <sub>8</sub> ins.		\$19.80	AZ10	"	"	33.00
	"	21.40	CX22	"	"	34.60
Sevres, . . . 27 <sup>1</sup> / <sub>4</sub> "		43.00	CX22	"	"	56.20
	"	56.20	SX52	"	"	69.40
Senlis, . . . 21 <sup>1</sup> / <sub>8</sub> "		37.50	CX22	"	"	50.70
	"	22.30	FX80	"	"	35.50
Sparta, . . . 14 <sup>5</sup> / <sub>8</sub> "		20.80	AZ10	"	"	34.00
	"	14.10	FX80	"	"	27.30

\*For article on "Metals and Finishes" see page 595, and for Nomenclature of Finishes and Explanation of Finish Symbols see page 609.

†Prices given are for Handles associated with 432 (p. 665) Flat Front Lock. For Lock with Rabbeted Front 432R (p. 665) add \$4.00. For other Store Door Locks see pages 664 to 666.



SIENA



TORCELLO



TOSCA



TREVISO



TRIANO



TOURAINE



URBINO



VARENNES



VERSAILLES



WENTWORTH

Ornamental Store Door Handles.

Cuts about  $\frac{1}{8}$  Size.

## Lock-sets for Store Doors.

TRIM: Illustrated on opposite page.

Handles in two appropriate finishes as given below.\*

Handles.	Length.	Per Pair.	Finish.*	Lock.	Each.	Per Set.†
Bona, . . . . .	18 $\frac{7}{8}$ ins.	\$46.20	CX22	432	\$13.20	\$59.40
	"	63.80	SY55	"	"	77.00
Bradford, illustrated and priced on page 760.						
Borcello, . . . . .	20 $\frac{1}{4}$ ins.	\$46.20	CX22	"	"	59.40
	"	25.60	FX80	"	"	38.80
Bosca, . . . . .	17 $\frac{1}{4}$ "	35.30	CY22	"	"	48.50
	"	45.20	SY52	"	"	58.40
Creviso, . . . . .	19 $\frac{3}{4}$ "	79.60	CY22	"	"	92.80
	"	98.10	SY52	"	"	111.30
Frison, . . . . .	17 "	43.20	CY22	"	"	56.40
	"	48.80	SY55	"	"	62.00
Fouraine, . . . . .	16 "	28.80	AZ17	"	"	42.00
	"	22.00	FX80	"	"	35.20
Urbino, . . . . .	20 $\frac{1}{4}$ "	17.40	FX80	"	"	30.60
	"	29.80	CX22	"	"	43.00
Varenes, . . . . .	20 $\frac{5}{8}$ "	39.60	AZ15	"	"	52.80
	"	52.80	SX52	"	"	66.00
Versailles, . . . . .	19 $\frac{1}{2}$ "	44.80	CY22	"	"	58.00
	"	50.60	SY52	"	"	63.80
Wentworth, . . . . .	22 "	32.20	FX80	"	"	45.40
	"	43.00	CX22	"	"	56.20

\*For article on "Metals and Finishes" see page 595, and for Nomenclature of Finishes and Explanation of Finish Symbols see page 609.

†Prices given are for Handles associated with 432 (p. 665) Flat Front Lock. For Lock with Rabbeted Front 432R (p. 665) add \$4.00. For other Store Door Locks see pages 664 and 666.



ADWA



AROUND AN



BRISTOL



ARNO



FLORAN



HELENIAN



IONIAN



MONCEAUX



MARATHON



LARGO

Ornamental Store Door Handles.  
Cuts about  $\frac{1}{8}$  Size.

## Lock-sets for Store Doors.

TRIM : Illustrated on opposite page.

Handles in two appropriate finishes as given below.\*

Handles.	Length.	Per Pair.	Finish.*	Lock.	Each.	Per Set.†
Adria, . . .	23 $\frac{5}{8}$ ins.	\$78.80	CX22	432	\$13.20	\$ 92.00
	"	97.40	SX52	"	"	110.60
Arcadian, . . .	15 "	16.50	CX22	"	"	29.70
Arno (Iron), . . .	17 $\frac{1}{2}$ "	5.80	FCZ17	"	"	19.00
Bristol, . . .	18 "	18.80	AZ10	"	"	32.00
	"	14.10	FX80	"	"	27.30
Florian, . . .	17 "	12.15	BZ36	"	"	25.35
Hellenian, . . .	16 "	16.50	AZ10	"	"	29.70
	"	17.60	CZ17	"	"	30.80
Ionian, . . .	"	16.50	AZ10	"	"	29.70
	"	17.60	CZ17	"	"	30.80
Lirgo, . . .	18 "	18.00	CX22	"	"	31.20
Monceaux, . . .	13 $\frac{1}{2}$ "	23.80	CY22	"	"	37.00
	"	33.00	SY52	"	"	46.20
Marathon, . . .	15 "	18.10	CZ17	"	"	31.30
	"	29.80	SY52	"	"	43.00

\* For article on "Metals and Finishes" see page 595, and for Nomenclature of Finishes, and Explanation of Finish Symbols see page 609.

† Prices given are for Handles associated with 432 (p. 665) Flat Front Lock. For Lock with Rabbeted Front 432R (p. 665) add \$4.00. For other Store Door Locks see pages 664 to 666.



MONACO



NAVARRO



NEMOURS



STRATFORD



ROKEBY

## Lock-sets for Store Doors.

Handles in two appropriate finishes as given below.\*

2 Handles.	Length.	Per Pair.	Finish.*	Lock.	Each.	Per Set.†
Monaco (Iron),	16 ins.	\$ 6.45	FAZ17	P2533	\$ 5.55	\$12.00
	" "	6.45	FCX17	"	"	12.00
Navarro, . . .	18 "	15.80	BX12	432	13.20	29.00
Nemours, . . .	21 $\frac{3}{4}$ "	23.30	FX80	"	"	36.50
Rokeby, . . .	14 $\frac{7}{8}$ "	22.40	CX22	"	"	35.60
	" "	15.80	FX80	"	"	29.00
Stratford, . . .	19 "	48.40	CX22	"	"	61.60
	" "	32.20	FX80	"	"	45.40

\*For article on "Metals and Finishes" see page 595, and for Nomenclature of Finishes and Explanation of Finish Symbols see page 609.

† Prices given are for Handles associated with 432 (p. 665) and P2533 (p. 664) Flat Front Locks. For Locks with Rabbeted Fronts add as follows: For 432R (p. 665) add \$4.00, for P2533R (p. 664) add \$2.65. For other Store Door Locks see pages 664 to 666.

# Part VI.

---

Plain Hardware.



## Part VI.

### Plain Hardware.

Section.	Pages.
1. Alphabets, . . . . .	801
2. Bell Pulls, . . . . .	763
3. Bolts—Barrel, Chain, Cremorne, Espagnolette, Extension, Flush and Foot, . . . . .	763-771, 887
4. Butts—Cabinet, Shutter, Loose Pin, etc., . . . . .	772-777
5. Casement Adjusters, . . . . .	778-781
6. Chain Door Fasteners, . . . . .	782
7. Catches—Cupboard, French Window, Elbow, Screen Door and Transom, . . . . .	782-784
8. Door Checks, Knobs, Pulls and Stops, . . . . .	786-791
9. Drawer Pulls, . . . . .	791
10. Escutcheon Plates, . . . . .	791
11. Fasteners for Bookcases, . . . . .	784
12. Frame Pulleys, . . . . .	791
13. Frames for Cards, . . . . .	792
14. Gate Fixtures, . . . . .	810
15. Handles—T and Lever, . . . . .	792-793
16. Hooks—Coat, Hat, Ceiling, Towel, etc., . . . . .	794-795
17. Kick Plates, . . . . .	801
18. Knobs—Door, Drawer, Shutter and Thumb, . . . . .	791-796
19. Letter Hole Plates, . . . . .	797
20. Letter Boxes—For Clubs, Office Buildings, etc., . . . . .	798-801
21. Numbers, . . . . .	801
22. Push Buttons, . . . . .	801
23. Push Plates, . . . . .	802-803
24. Sash Bolts, Centers, Fasts, Hooks, Lifts, etc., . . . . .	804-809
25. Sliding Door Latches, . . . . .	810
26. Signs, . . . . .	811
27. Shutter Bars, . . . . .	812
28. Transom Chains and Lifters, . . . . .	812-815
29. Turnbuckles, Rim and Mortise, . . . . .	816-817
30. Turns for Cupboards, . . . . .	785
31. Water Closet Trim, . . . . .	818-820

## Bell Pulls.

Base,  $3 \times 1\frac{1}{2}$  inches.

No.		Each.*
1213,	Oval Knob, $2\frac{1}{4} \times 1\frac{1}{2}$ ins.	\$3 30
1217,	Egg " $2\frac{1}{4} \times 1\frac{1}{2}$ "	3 30
1255,	Spheroid " $1\frac{3}{4}$ "	1 50
1285,	Sphere, " 2 "	2 20

Also made with electric attachment.



1255



1680



290



294



93



91



92

## Barrel Bolts.

1680,	$2\frac{1}{2}$ inches over all,	\$ .85
1682,	3 " " "	1.00
1684,	4 " " "	1.20

## Necked Bolts.

290,	Case, $1 \times 3$ inches,	\$ .90
291,	" $1 \times 5$ "	1.20
292,	" $1 \times 6$ "	1.65

## Square Bolts.

294,	Case, $1 \times 4$ inches,	\$1.20
------	----------------------------	--------

## Square Cased Bolts.

90,	Case, $1\frac{3}{8} \times 2\frac{1}{2}$ inches,	\$1.00
93,	" $1\frac{1}{2} \times 3$ "	1.20
94,	" $1\frac{1}{2} \times 5$ "	2.20

## Mortise Door Bolts.

Diameter of Bolt,  $\frac{1}{2}$  inch.

With Crescent Thumb-Knob.

91,	Front, $2 \times 7\frac{7}{8}$ ins, Backset, 1 in.	\$ .80
95,	" " " " 2 "	.80

With Round Knob.

92,	Front, $2 \times 7\frac{7}{8}$ ins, Backset, 1 in.	\$ .80
96,	" " " " 2 "	.80

\* In Buffed Bronze or Brass. For article on "Metals and Finishes" see page 595, and for Nomenclature of Finishes and Explanation of Finish Symbols see page 609.

See Note as to Method of Pricing, page 33. Cuts  $\frac{1}{4}$  Size.



1664



1674

## Chain and Foot Bolts.

Buffed Bronze or Brass.

Chain Bolts are regularly furnished with Rim Strikes but will be provided with Reverse Bevel Strikes when so ordered.

## CHAIN BOLTS.

No.	Case,	Dimensions	Each
1660,	Case,	$2 \times 1 \frac{1}{2}$ inches,	\$1.50
1661,	"	$3 \times 1 \frac{3}{4}$ "	1.55
1662,	"	$4 \times 1 \frac{7}{8}$ "	1.75
1663,	"	$5 \times 2 \frac{1}{8}$ "	2.25
1664,	"	$6 \times 2 \frac{1}{8}$ "	2.45
1665,	"	$8 \times 2 \frac{1}{8}$ "	3.50

## FOOT BOLTS.

1672,	Case,	$4 \times 2 \frac{1}{8}$ inches	\$1.55
1674,	"	$6 \times 2 \frac{1}{8}$ "	2.65
1675,	"	$8 \times 2 \frac{1}{8}$ "	3.50

\*Also made in Iron. For article on "Metals and Finishes" see page 595, and for Nomenclature of Finishes and Explanation of Finish Symbols see page 609.

See Note as to Method of Pricing, page 33. Cuts  $\frac{1}{4}$  Size.

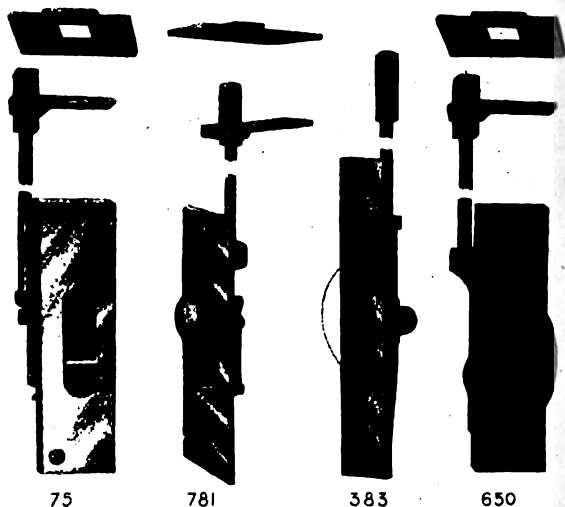

## Extension Bolts.

Buffed Bronze or Brass.\*

WITH SUNK THUMB-PIECE.

						Each.
5,	Light:	Plate,	$5\frac{1}{2} \times 1\frac{1}{2}$	inches,	.	\$3.20
1,	Heavy:	"	$5\frac{5}{8} \times 1$	"	.	3.20
3,	"	"	$\times 1\frac{1}{4}$	"	.	3.20
8,	"	"	$\times 1\frac{1}{2}$	"	.	3.20

WITH KNOB.

1,	Light:	Plate,	$5\frac{1}{2} \times 1\frac{1}{2}$	inches,	.	2.90
0,	"	"	"	"	.	2.90
1,	Heavy:	"	$5\frac{5}{8} \times 1$	"	.	2.90
3,	"	"	$\times 1\frac{1}{4}$	"	.	2.90
8,	"	"	$\times 1\frac{1}{2}$	"	.	3.40

WITH LEVER.

0,	Heavy:	Plate,	$5 \times \frac{5}{8}$	inches,	.	4.00
3,	"	"	$6\frac{5}{8} \times 1\frac{1}{4}$	"	.	4.00

Standard length of rod as priced, 24 inches. For each additional 12 inches rod, or fraction thereof, add 25 cents.

Nos. 75 and 650 also made in Iron. For article on "Metals and Finishes" see e 595, and for Nomenclature of Finishes and Explanation of Finish Symbols see e 609.

See Note as to Method of Pricing, page 33. Cuts  $\frac{1}{4}$  Size.

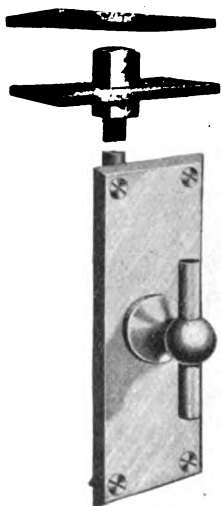

988

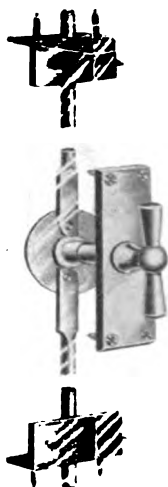

892

### Extension Bolts.

No.	SINGLE FLUSH BOLT.	Ex. 15
888,	Plate, $7 \times 1 \frac{3}{4}$ inches, length of rod 12 inches,	\$ 2.50
988,	" $7 \times 2 \frac{1}{2}$ " " " " " " "	10.00

For each additional foot of rod add 25 cents.

#### DOUBLE SURFACE BOLT.

892,	Plate, $3 \times 1$ inches, length of rods, 4 feet,	6.00
------	---	------

For each additional foot of rod (up to 8 feet) add 35 cents.

When specifying bolt No. 892 give height and thickness of door, distance from bottom of door to desired position of T Handle, also sectional detail of head and sill.

\*In Buffed Bronze or Brass. For article on "Metals and Finishes" see page 600 and for Nomenclature of Finishes and Explanation of Finish Symbols see page 600.

See Note as to Method of Pricing, page 33. Cuts  $\frac{1}{4}$  Size.

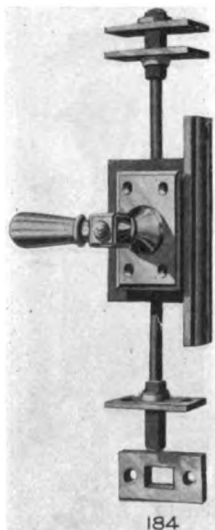

## Extension Bolts.

## DOUBLE RIM BOLTS.

	Each.*
Case, $4 \times 1\frac{3}{8} \times \frac{1}{2}$ ins., length, 7 feet, . . . . .	\$10.60
“ $9\frac{1}{2} \times 3\frac{7}{8} \times 1$ “ “ 9 “ 6 ins., . . . . .	19.80
“ $6\frac{1}{8} \times 1\frac{3}{4} \times \frac{7}{8}$ “ “ 9 “ 6 “ . . . . .	13.25

For each additional foot of rod add 55 cents.

When specifying give height of door and distance from bottom to desired position of handle, style of strike (mortise or rim), desired; also state if door sill is to be of wood, metal or stone. Illustration shows rim strike at top and mortise strike at bottom.

## DOUBLE MORTISE BOLTS.

Case, $3 \times 2\frac{1}{8} \times \frac{3}{4}$ ins.; Front $4 \times \frac{7}{8}$ ins., length, 8 feet, . . . . .	\$16.00
“ “ “ “ “ “ “ “ “ “ “ “ . . . . .	18.30

For each additional foot of rod add 15 cents.

No. 184 is occasionally used as a strike for double doors and can be furnished with any trim to match inside trim on active leaf of door.

No. 384 operates bolts at top, bottom and center simultaneously.

When specifying give complete measurements and sectional details.

In Buffed Brass or Bronze. For article on “Metals and Finishes” see page 595.

See Note as to Method of Pricing, page 33. Cuts  $\frac{1}{4}$  Size.

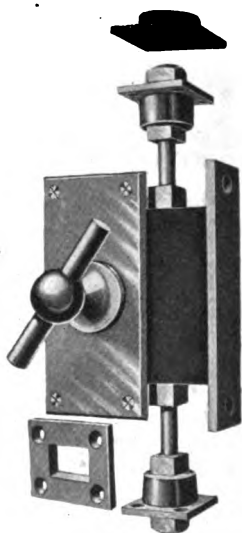

188

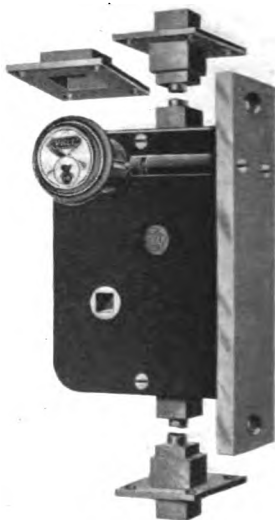

186

### Double Mortise Extension Bolts.

No.	Each.*
188, Case, $3\frac{3}{4} \times 4\frac{7}{8}$ inches, length, 8 feet, . . . . .	\$16.00
Additional Rod, . . . . .	per foot, .15
Plate, $5\frac{3}{8} \times 2\frac{1}{2}$ inches: Front, $6\frac{1}{8} \times 1\frac{1}{4}$ inches:	
Backset of Rod, $2\frac{3}{4}$ inches.	

#### FOR EXTRA HEAVY DOORS.

186, Case, $6\frac{1}{4} \times 4\frac{7}{8}$ inches, length, 8 feet, . . . . .	\$35.00
Additional Rod, . . . . .	per foot, .15
Front, $8\frac{5}{8} \times 1\frac{1}{4}$ inches: Backset of Rod, $2\frac{3}{4}$ inches.	

Can be used as a strike for double doors and also furnished with dummy trim to match inside trim on active leaf of door.

When specifying give complete measurements and sectional details.

\* In Buffed Brass or Bronze. For article on "Metals and Finishes" see page 595 and for Nomenclature of Finishes and Explanation of Finish Symbols see page 600.

See Note as to Method of Pricing, page 33. Cuts  $\frac{1}{4}$  Size.



1620



1715



485



483

## Flush Bolts.

Buffed Bronze or Brass.\*

No.		Plate from	Each.
1620,	With Knob.	8 × 1 <sup>1</sup> / <sub>8</sub> inches up to 24 × 1 <sup>1</sup> / <sub>8</sub> inches.	from \$2.10 to \$4.60
1715,	With Sunk Thumb-piece.	6 × 1 inches up to 15 × 1 inches.	from \$1.70 to 4.60
480,	With Sunk Thumb-piece.	4 × 5 <sup>3</sup> / <sub>8</sub> inches up to 18 × 5 <sup>3</sup> / <sub>8</sub> inches.	from \$1.60 to 2.90
480 <sup>3</sup> / <sub>4</sub> ,	With Sunk Thumb-piece.	24 × 3 <sup>3</sup> / <sub>4</sub> or 36 × 3 <sup>3</sup> / <sub>4</sub> inches.	\$4.00 and 5.00
485,	With Sunk Thumb-piece.	2 <sup>1</sup> / <sub>2</sub> × 1 <sup>1</sup> / <sub>2</sub> inches up to 6 × 1 <sup>1</sup> / <sub>2</sub> inches.	from \$ .15 to .30
481,†	With Sunk Thumb-piece.	6 × 1 inches up to 42 × 1 inches.	from \$3.00 to 10.20
482,†	With Sunk Thumb-piece.	6 × 1 <sup>1</sup> / <sub>8</sub> inches up to 12 × 1 <sup>1</sup> / <sub>8</sub> inches.	from \$3.10 to 3.85
483,†	With Sunk Thumb-piece.	6 × 1 <sup>1</sup> / <sub>4</sub> inches up to 36 × 1 <sup>1</sup> / <sub>4</sub> inches.	from \$3.20 to 9.25
484,†	With Sunk Thumb-piece.	6 × 1 <sup>1</sup> / <sub>2</sub> inches up to 12 × 1 <sup>1</sup> / <sub>2</sub> inches.	from \$3.20 to 4.00

\* Nos. 1620 and 1715 also made in Iron. For article on "Metals and Finishes" see page 595, and for Nomenclature of Finishes and Explanation of Finish Symbols see page 609.

† Can be furnished with Spring bolts if desired, at additional cost.

See Note as to Method of Pricing, page 33. Cuts 1<sup>1</sup>/<sub>4</sub> Size.



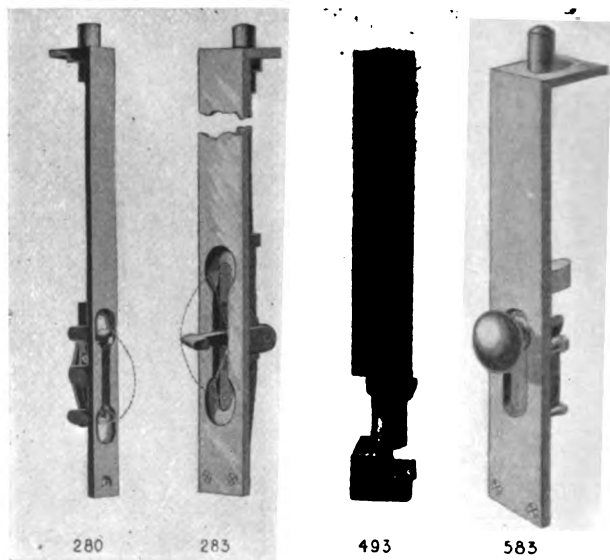

No.	Flush Bolts.	Each *
280,	With Lever. Plate from $6 \times \frac{5}{8}$ inches up to $48 \times \frac{5}{8}$ inches.	from \$2.65 to \$18.00
281,	With Lever. Plate from $6 \times 1$ inches up to $48 \times 1$ inches.	from \$4.00 to 18.50
283,	With Lever. Plate from $6 \times 1\frac{1}{4}$ inches up to $48 \times 1\frac{1}{4}$ inches.	from \$4.00 to 18.50
494,	With Sunk Thumb-piece; for Dutch doors. Plate $4\frac{3}{4} \times 1\frac{1}{4}$ inches.	6.60
493,	With Sunk Thumb-piece; for Dutch doors. Plate $7\frac{1}{8} \times 1\frac{1}{4}$ inches.	6.60
581,	With Thumb-knob. Plate from $6 \times 1$ inches up to $42 \times 1$ inches.	from \$3.30 to 10.60
582,	With Thumb-knob. Plate from $6 \times 1\frac{1}{8}$ inches up to $48 \times 1\frac{1}{8}$ inches.	from \$3.30 to 13.20
583,	With Thumb-knob. Plate from $6 \times 1\frac{1}{4}$ inches up to $60 \times 1\frac{1}{4}$ inches.	from \$3.70 to 27.00
584,	With Thumb-knob. Plate from $6 \times 1\frac{1}{2}$ inches up to $60 \times 1\frac{1}{2}$ inches.	from \$3.70 to 27.00

\* In Buffed Brass or Bronze. For article on "Metals and Finishes" see page 594 and for Nomenclature of Finishes and Explanation of Finish Symbols see page 609

See Note as to Method of Pricing, page 33. Cuts  $\frac{1}{4}$  Size.

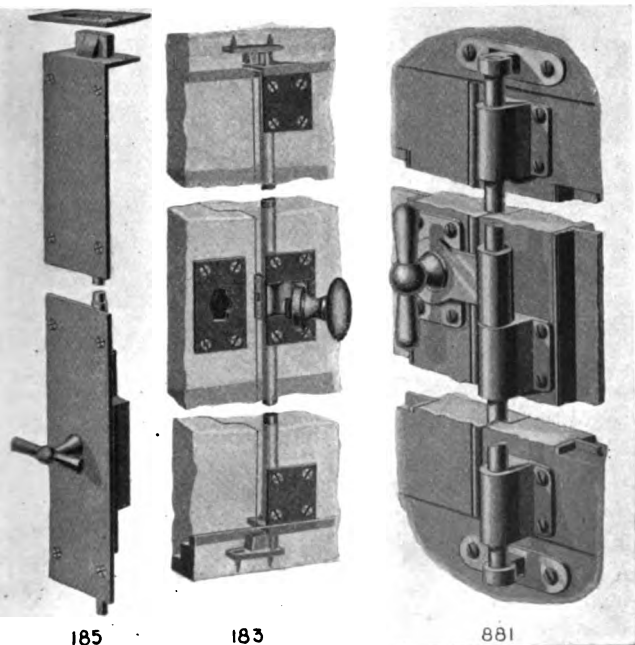

185

183

881

## Espagnolette Bolts.

Each.\*

- No. 85, Top and Bottom Plates,  $5 \times 1\frac{1}{2}$  inches; Center Plate,  $7 \times 1\frac{3}{4}$  inches; length, 7 ft. Reversible. . . . . \$13.20  
 Additional Rod, . . . . . per foot, .15

The bolts are thrown positively by a quarter turn of T-handle; by an additional quarter turn the windows are wedged firmly against the frame.

- No. 83, Plate and Strike,  $2\frac{3}{4} \times 1\frac{1}{2}$  ins.; length, 7 ft. Not Reversible. \$12.00  
 Additional Rod, . . . . . per foot, 1.00

By giving the Knob a quarter turn the Strap or Bar can be thrown back, thus turning the bolt rods and releasing the hooks from the Strikes. By means of a cam the hooks, closing, draw the sash tightly against the jamb and prevent rattling.

- No. 81, For French Windows, width of Stile,  $1\frac{1}{4}$  inches, . . . . . \$15.85  
 No. 82, " " " " " " 2 " " " " 15.85

Additional Rod, . . . . . per foot, 1.00

When Specifying, give complete measurements and sectional details.

\* In Buffed Brass or Bronze: For article on "Metals and Finishes" see page 595, and for Nomenclature of Finishes and Explanation of Finish Symbols see page 609.

See Note as to Method of Pricing, page 35. Cuts  $\frac{1}{4}$  Size.

## Cremorne Bolts.

For Plain and Ornamental Cremorne Bolts see page 887.



150



150 B



## Shutter Butts.

Buffed Bronze or Brass.\*

No.				Pat.
150,	Square edge,	$2 \times 1\frac{3}{4}$ inches,		\$ .85
"	"	" $2 \times 2$ "		.95
"	"	" $2\frac{1}{2} \times 2\frac{1}{2}$ "		1.25
"	"	" $3 \times 3$ "		1.55
150B,	Beveled edge,	$2 \times 1\frac{3}{4}$ "		.95
"	"	" $2 \times 2$ "		1.15
"	"	" $2\frac{1}{2} \times 2\frac{1}{2}$ "		1.45
"	"	" $3 \times 3$ "		2.05

Also made in 20 additional sizes from  $1\frac{1}{2} \times 1$  inches up to  $4 \times 3$  inches.

Wrought Steel, Bower-Barffed.\*

9838,	Square edge,	$2 \times \frac{5}{8}$ inches (Illustrated on page 774),	\$ .25
"	"	" $2\frac{1}{4} \times 1\frac{3}{4}$ "	.25
"	"	" $3 \times 2$ "	.35

\*For article on "Metals and Finishes" see page 595, and for Nomenclature of Finishes and Explanation of Finish Symbols see page 609.

See Note as to Method of Pricing, page 33. Cuts  $\frac{1}{4}$  Size.



50



50B



60



60B

## Shutter Flaps.

Buffed Bronze or Brass.\*

No.								Pair.
50,	Square edge,	$1\frac{1}{4} \times 1\frac{3}{4}$	inches,	.	.	.	.	\$ .75
"	"	$1\frac{1}{2} \times 2\frac{1}{4}$	"	.	.	.	.	.85
50B,	Beveled edge,	$1\frac{1}{4} \times 1\frac{3}{4}$	inches,	.	.	.	.	.85
"	"	$1\frac{1}{2} \times 2\frac{1}{4}$	"	.	.	.	.	.95
60,	Square edge, 3 fold,	$1\frac{1}{4} \times 2$	inches,	.	.	.	.	1.65
"	"	$1\frac{1}{2} \times 2\frac{1}{4}$	"	.	.	.	.	2.20
60B,	Beveled edge,	$1\frac{1}{4} \times 2$	"	.	.	.	.	2.30
"	"	$1\frac{1}{2} \times 2\frac{1}{4}$	"	.	.	.	.	2.75

Nos. 50 and 50B, made in 9 additional sizes from  $1 \times 1\frac{1}{2}$  ins. up to  $1\frac{3}{4} \times 2\frac{1}{2}$  ins.

160



160B

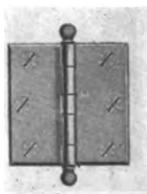

## Cabinet Butts.

Buffed Bronze or Brass.\*

No.								Pair.
160,	Square edge,	2	$\times 1\frac{3}{4}$	inches.	.	.	.	\$1.00
"	"	2	$\times 2$	"	.	.	.	1.10
"	"	$2\frac{1}{2}$	$\times 2\frac{1}{2}$	"	.	.	.	1.40
"	"	3	$\times 3$	"	.	.	.	2.00
160B,	Beveled edge,	2	$\times 1\frac{3}{4}$	"	.	.	.	1.15
"	"	2	$\times 2$	"	.	.	.	1.30
"	"	$2\frac{1}{2}$	$\times 2\frac{1}{2}$	"	.	.	.	1.60
"	"	3	$\times 3$	"	.	.	.	2.20

Also made in 20 additional sizes from  $1\frac{1}{2} \times 1$  inches up to  $4 \times 3$  inches.

\*For article on "Metals and Finishes" see page 595, and for Nomenclature of Finishes, and Explanation of Finish Symbols, see page 609.

See Note as to Method of Pricing, page 33. Cuts  $\frac{1}{4}$  Size.

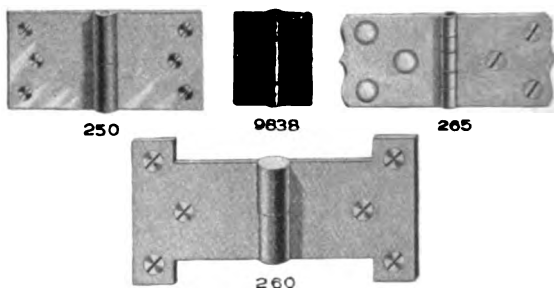

### Loose and Fast Joint Butts.

Buffed Bronze or Brass.\*

#### LOOSE JOINT BUTTS.

Not Reversible. Hand must be Specified.

No.		Pair.
250,	2 × 4 inches, . . . . .	\$3.75
"	2 × 4½ " " . . . . .	4.40
260,	Parliament, 1¾ × 2¾ inches, . . . . .	1.00
"	" " 3 × 6 " " . . . . .	10.00
270,	" " With Tips, 1¾ × 2¾ inches, . . . . .	1.20
"	" " " " 3 × 6 " " . . . . .	10.00

#### FAST JOINT SURFACE BUTTS.

Not Reversible. Hand must be Specified.

265,	For Wood, 1⅞ × 4½ inches, . . . . .	\$2.65
"	" " Marble, " " . . . . .	6.00
"	" " " 3½ × 5 " " . . . . .	8.85

\*For article on "Metals and Finishes" see page 595, and for Nomenclature of Finishes and Explanation of Finish Symbols see page 609.

See Note as to Method of Pricing, page 33. Cuts ¼ Size.



147

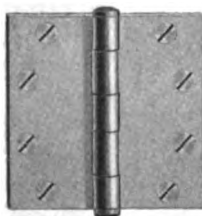

350



785

## Fast Joint Butts.

Buffed Bronze or Brass.\*

No.	Pair.
147, Fast Joint Transom Butts, 6 sizes from $2\frac{1}{2} \times 2\frac{1}{2}$ inches up to $4 \times 4$ inches. . . . .	from \$1.25 to \$ 3.20
350, Heavy Fast Joint Butts, 18 sizes from $2 \times 2$ inches up to $12 \times 12$ inches. . . . .	from \$2.00 to 96.80
785, Medium Weight Fast Joint Butts, 9 sizes from $2 \times 2$ inches up to $6 \times 6$ inches. . . . .	from \$2.00 to 11.00



9808

## Fast Joint Butts.

Wrought Steel, Bower-Barffed.\*

No.	Pair.
9808, 8 sizes from $2 \times 2$ inches up to $5 \times 5$ ins., from \$ .55 to \$2.20	

\*For article on "Metals and Finishes" see page 595, and for Nomenclature of Finishes and Explanation of Finish Symbols see page 609.

See Note as to Method of Pricing, page 33. Cuts  $\frac{1}{4}$  Size.

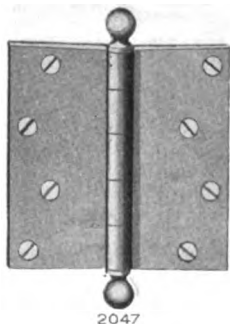

2047

## Loose Pin Butts.

Iron, Bronze Plated.\*

No.	Size	Pair
2047,	2 1/2 X 2 1/2 ins.,	\$ .75
"	3 X 3 "	.80
"	3 1/2 X 3 1/2 "	.95
"	4 X 4 "	1.05
"	4 1/2 X 4 1/2 "	1.20
"	5 X 5 "	1.45
"	5 X 6 "	2.00
"	5 1/2 X 5 1/2 "	1.85
"	6 X 6 "	2.25

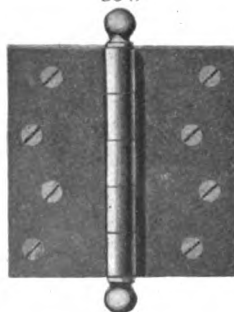

9239

Wrought Steel, Bowyer-Barbed.\*

9239,	2 X 2 ins.,	\$ .95
"	2 1/2 X 2 1/2 "	1.05
"	3 X 3 "	1.20
"	3 1/2 X 3 1/2 "	1.50
"	4 X 4 "	1.65
"	4 1/2 X 4 1/2 "	2.25
"	5 X 5 "	2.65
"	5 1/2 X 5 1/2 "	3.30
"	5 X 6 "	3.30
"	5 X 7 "	4.00
"	6 X 6 "	4.00

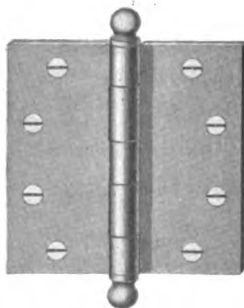

9241

Wrought Steel, Bowyer-Barbed.\*

9241,	2 X 2 ins.,	\$ .60
"	2 1/2 X 2 1/2 "	.85
"	3 X 3 "	1.00
"	3 1/2 X 3 1/2 "	1.20
"	4 X 4 "	1.45
"	4 1/2 X 4 1/2 "	1.80
"	5 X 5 "	2.25
"	5 1/2 X 5 1/2 "	2.85
"	6 X 6 "	3.85

\*For article on "Metals and Finishes" see page 595, and for Nomenclature of Finishes and Explanation of Finish Symbols see page 609.

See Note as to Method of Pricing, page 33. Cuts 1/4 Size.

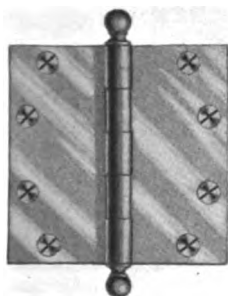

780



750

## Loose Pin Butts.

Buffed Bronze or Brass.\*

No. 780, Medium, steel bushed, self-lubricating; with "hold-fast" pins, except sizes under  $3\frac{1}{2} \times 3\frac{1}{2}$  inches.

Size.	Pair.	Size.	Pair.
2 $\times$ 2 inches, . . .	\$ 2.00	$4\frac{1}{2} \times 4\frac{1}{2}$ inches, . . .	\$ 6.00
$2\frac{1}{2} \times 2\frac{1}{2}$ " . . .	2.65	5 $\times$ 5 " . . .	6.60
3 $\times$ 3 " . . .	3.60	$5\frac{1}{2} \times 5\frac{1}{2}$ " . . .	8.85
$3\frac{1}{2} \times 3\frac{1}{2}$ " . . .	4.25	6 $\times$ 6 " . . .	11.00
4 $\times$ 4 " . . .	5.10		

Also made in 41 irregular sizes from  $1\frac{3}{4} \times 2$  ins. up to  $10 \times 6$  ins.; and also in Iron.

No. 750, Extra Heavy, steel bushed, self-lubricating; with "hold-fast" pins:

Size.	Pair.	Size.	Pair.
3 $\times$ 3 inches, . . .	\$ 4.25	6 $\times$ 6 inches, . . .	\$14.35
$3\frac{1}{2} \times 3\frac{1}{2}$ " . . .	4.90	6 $\times$ 7 " . . .	24.25
4 $\times$ 4 " . . .	6.40	6 $\times$ 8 " . . .	35.25
$4\frac{1}{2} \times 4\frac{1}{2}$ " . . .	8.00	6 $\times$ 9 " . . .	44.00
5 $\times$ 5 " . . .	9.30	6 $\times$ 10 " . . .	70.50
$5\frac{1}{2} \times 5\frac{1}{2}$ " . . .	12.15	7 $\times$ 7 " . . .	24.25
5 $\times$ 6 " . . .	11.50	8 $\times$ 8 " . . .	35.25
5 $\times$ 7 " . . .	15.50	12 $\times$ 12 " . . .	96.80

Also made in 29 irregular sizes from  $2\frac{1}{2} \times 1\frac{1}{2}$  ins. up to  $16 \times 12$  ins.; and also in Iron.

\*For article on "Metals and Finishes" see page 595, and for Nomenclature of Finishes and Explanation of Finish Symbols see page 609.

See Note as to Method of Pricing, page 33. Cuts  $\frac{1}{4}$  Size.



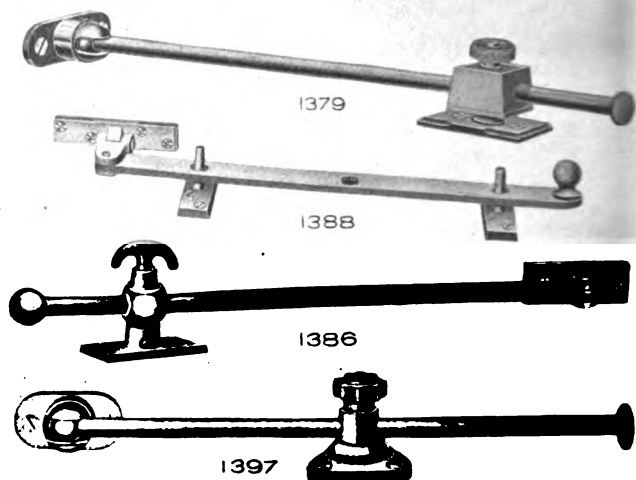

## Casement Adjusters.

No.		Each.*
1379,	for Casements opening <i>out</i> . Standard Plate, $2\frac{1}{8} \times 1\frac{1}{8}$ inches. Rod: diameter $\frac{3}{8}$ inch, length 12 inches, . . . . .	\$2.90
1388,	for Casements opening <i>out</i> (a locking adjuster used principally for casements hinged at top). 2 Standard Plates, $\frac{3}{4} \times 2\frac{1}{8}$ inches. Bar: $\frac{1}{4} \times \frac{3}{4}$ inches, length 10 inches, . . . . .	4.50
1386,†	for Casements opening <i>out</i> . Standard Plate, $2\frac{1}{4} \times 7\frac{7}{8}$ inches. Rod: diameter $\frac{3}{8}$ inch, length 12 inches, . . . . .	3.00
1397,†	for Casements opening <i>out</i> . Standard Plate, $1\frac{5}{8} \times 1\frac{3}{8}$ inches. Rod: diameter $\frac{5}{16}$ inch, length 12 inches, . . . . .	4.50

For each additional inch of Rod for above add 25 cents, except for No. 1397, for which add 45 cents.

\* In Buffed Bronze or Brass. No. 1386 also made in Iron. For article on "Metals and Finishes" see page 595, and for Nomenclature of Finishes and Explanation of Finish Symbols see page 609.

† The Posts of Nos. 1386 and 1397 may be made to fit special conditions at slight extra cost.

See Note as to Method of Pricing, page 33. Cuts  $\frac{1}{4}$  Size

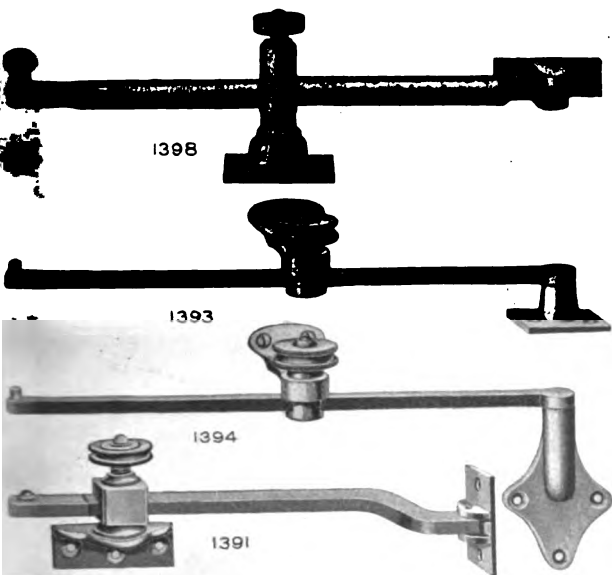

Casement Adjusters.

No.	Each.*
1398, † for Casements opening <i>out</i> . Standard Plate, $2\frac{1}{4} \times 1\frac{1}{2}$ inches. Rod: diameter $\frac{5}{8}$ inches, length 12 inches, . . . . .	\$10.50
1393, † for Casements opening <i>in</i> , with Stool. Pivot Plate, $1\frac{1}{8} \times 1\frac{5}{8}$ inches. Bar: $\frac{1}{2} \times \frac{1}{4}$ inches, length 12 inches, . . . . .	4.50
1394, † for Casements opening <i>in</i> , without Stool. Pivot Plate, $1 \times \frac{3}{4}$ inches. Bar: $\frac{1}{2} \times \frac{1}{4}$ inches, length 12 inches, . . . . .	4.50
1391, for Casements opening <i>in</i> , recessed or with Sloping Stool. Standard Plate, $\frac{7}{8} \times 2\frac{1}{8}$ inches. Bar: $1\frac{1}{4} \times \frac{5}{8}$ inches, length $9\frac{3}{8}$ inches, . . . . .	6.60
For each additional inch of Rod or Bar for above add 45 cents.	

\* In Buffed Bronze or Brass For article on "Metals and Finishes" see page 595, and for Nomenclature of Finishes and Explanation of Finish Symbols see page 609.

† Posts may be made to fit special conditions at slight extra cost.

See Note as to Method of Pricing, page 33. Cuts  $\frac{1}{4}$  Size.

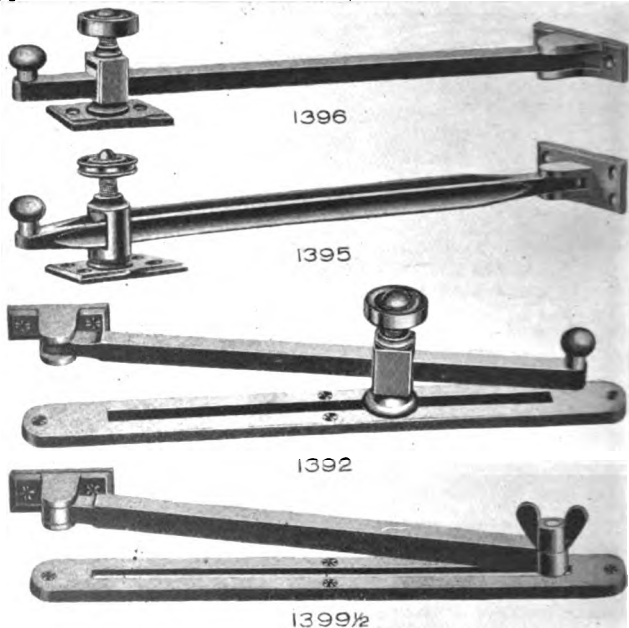

## Casement Adjusters.

No.		Each.*
1396,†	for Casements opening out. Standard Plate, $2\frac{1}{8} \times 1$ inches. Bar: $\frac{3}{8} \times \frac{1}{2}$ inches, length 12 inches, . . . . . For each additional inch of Bar add 45 cents.	\$6.60
1395,†	for Casements opening out. Standard Plate, $2\frac{5}{8} \times 1\frac{1}{8}$ inches. Rod: $\frac{1}{2} \times \frac{1}{2}$ inch, length 8 inches, . . . . . Made also with 12 inches of Rod, \$8.85; 18 inches, \$10.00, or 24 inches, \$11.00.	7.75
1392,	for Casements opening out. Plate, $12\frac{1}{2} \times 1\frac{1}{4}$ inches. Length of Bar, 12 inches. . . . .	7.75

\* In Buffed Bronze or Brass. For article on "Metals and Finishes" see page 595, and for Nomenclature of Finishes and Explanation of Finish Symbols, see page 609.

† Posts may be made to fit special conditions at slight extra cost.

See Note as to Method of Pricing, page 33. Cuts  $\frac{1}{4}$  Size.

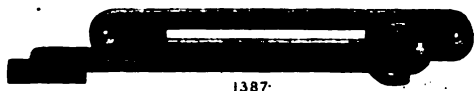

1387



1390



1399

Casement Adjusters.

No.	Each.*
1387, for Casements opening <i>in</i> or <i>out</i> . Plate, $11 \times 1\frac{1}{4}$ inches. Length of Bar, $9\frac{1}{2}$ inches, . . . . .	\$ 6.00
1390, for Casements opening <i>out</i> , where Screens are used. Plate, $15\frac{3}{8} \times 1\frac{1}{4}$ inches. Bar: $\frac{7}{8}$ inch square, length 11 inches,	17.60
Specially suitable for windows with inside screens, as arm does not extend into room. The only adjuster made which renders it impossible for the window to be swung in unless so desired: stops prevent slipping.	
1399, for Casements opening <i>out</i> , especially where inside Screens are used. Plate, $8\frac{1}{4} \times 1\frac{1}{4}$ inches. Length of Bar, $7\frac{1}{2}$ inches,	2.45
Made also with Plate $7 \times 1$ inches and 6 inches of Bar, \$2.45; with Plate $12 \times 1\frac{1}{4}$ inches and 12 inches of Bar, \$2.90; with Plate $15 \times 1\frac{1}{2}$ inches and 15 inches of Bar, \$3.25; with Plate $18 \times 1\frac{1}{2}$ inches and 18 inches of Bar, \$3.60.	
1399 $\frac{1}{2}$ , for Casements opening <i>out</i> , where Screens are used. Plate, $12\frac{1}{2} \times 1\frac{1}{4}$ inches. Length of Bar, 12 ins. (see 1399, page 781)	6.60

\* In Buffed Brass or Bronze. For article on "Metals and Finishes" see page 595, and for Nomenclature of Finishes and Explanation of Finish Symbols see page 609.

See Note as to Method of Pricing, page 33. Cuts  $\frac{1}{4}$  Size.

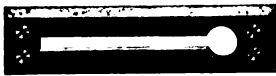

Chain  
Door Fastener.



625

Buffed Bronze or Brass.\*

No.	Each.
625, Case, $1\frac{3}{8} \times 5\frac{3}{4}$ ins.;	
Strike, $2 \times 1\frac{3}{8}$ ins.;	
Chain, 9 ins.,	\$2.40



512



1181



1481



1485



705



1486

Cupboard Catches and Bolts.

Buffed Bronze or Brass.\*

No.	Each.
512, Case, $1\frac{1}{2} \times 1\frac{3}{4}$ inches,	\$ .75
513, " $1\frac{1}{2} \times 2\frac{3}{4}$ "	.80
1181, " $1\frac{1}{4} \times 1\frac{7}{8}$ "	1.85
1481, " $1\frac{1}{4} \times 2$ "	1.50
1485, " $2 \times 1\frac{1}{8}$ "	1.60
1486, " $1\frac{3}{4} \times 1\frac{3}{8}$ "	1.50
705, " $1\frac{5}{8} \times 1\frac{3}{4}$ "	1.00

Nos. 625, 512 and 513 also made in Iron.

\*For article on "Metals and Finishes" see page 595, and for Nomenclature of Finishes and Explanation of Finish Symbols see page 609.

See Note as to Method of Pricing, page 33. Cuts  $\frac{1}{4}$  Size.



605



1184



1188 RIM STRIKE



1188 MORTISE STRIKE



1187



1186



1189

Transom Catches.

No.	Case,	Dimensions	inches.	Each.*
605,	Case,	$1\frac{3}{8} \times 1\frac{1}{4}$		\$ .60
1186,	"	$2\frac{1}{8} \times 2\frac{1}{8}$	"	2.20
1187,	"	$2 \times 2\frac{3}{8}$	"	2.80
1188,	"	$2\frac{1}{8} \times 1\frac{1}{4}$	"	1.45
1189,	Face,	$1 \times 1\frac{1}{2}$	"	1.60
1184,	"	$\frac{7}{8} \times 1\frac{1}{2}$	"	.90
			Selvage, $1\frac{3}{8} \times 1$ inches.	
			" $1\frac{3}{8} \times 1\frac{1}{2}$ "	



530



531

Catches for Screen Doors.

Outside Trim: Lever Handle and Plate. Backset  $1\frac{1}{4}$  inches.

No.	Case,	Dimensions	inches.	Each.*
530,	Box Rim Strike.	$2\frac{1}{4} \times 1\frac{7}{8}$		\$2.00
531,	Mortise Strike.	"	"	2.00
532,	Flush Rim Strike.	"	"	2.00

\*In Buffed Brass or Bronze: Also made in Iron, except No. 1188. For article on "Metals and Finishes" see page 595, and for Nomenclature of Finishes and Explanation of Finish Symbols see page 609.

See Note as to Method of Pricing, page 33. Cuts  $\frac{1}{4}$  Size.



1175



701



510

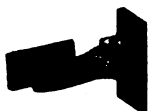

1193



1190



505

## Catches, Bolts and Fasteners.

Buffed Bronze or Brass.\*

## BOOK CASE FASTENER.

No.		Each.
1175,	Front, $3\frac{1}{4} \times \frac{5}{8}$ inches,	\$ .65

## RIM CUPBOARD BOLTS.

700,	Case, $2 \times \frac{1}{2}$ inches,	\$ .35
701,	" $3 \times \frac{1}{2}$ "	.60

## FRENCH WINDOW CATCHES.

505,†	" $1\frac{3}{8} \times 1\frac{1}{4}$ inches,	\$ .55
510,†	" $1\frac{7}{8} \times 1\frac{1}{2}$ "	.60

## ELBOW CATCHES.

1190,†	Plate, $\frac{1}{2} \times 1\frac{1}{2}$ inches, Hook, $1\frac{5}{16}$ inches,	\$ .80
1191,†	" $\frac{5}{8} \times 1\frac{1}{4}$ " " $1\frac{1}{4}$ "	.30
1193,†	" $1 \times 2$ " " $2\frac{1}{4}$ "	1.80

\* For article on "Metals and Finishes" see page 595, and for Nomenclature of Finishes and Explanation of Finish Symbols see page 609.

† Also made in Iron.

See Note as to Method of Pricing, page 33. Cuts  $\frac{1}{4}$  Size.

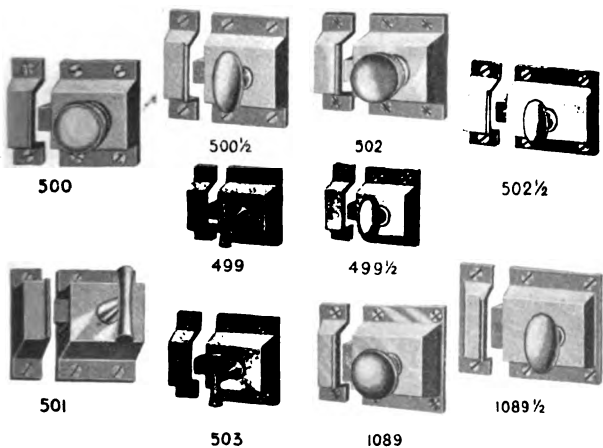

Cupboard Turns.

Buffed Bronze or Brass.\*

WITH T-HANDLE.

No.	Case,	Dimensions	Each
499,	$1\frac{1}{2} \times 1$	inches, . . . . .	\$ .90
503,	$1\frac{3}{4} \times 1\frac{3}{4}$	" . . . . .	.90
501,	$2\frac{1}{4} \times 1\frac{5}{8}$	" . . . . .	1.05

WITH ROUND KNOB.

502,	$1\frac{3}{4} \times 1\frac{3}{4}$	inches, . . . . .	\$ .90
500,	$2\frac{1}{4} \times 1\frac{5}{8}$	" . . . . .	1.05
1089,	$2 \times 2\frac{1}{4}$	" . . . . .	1.35

WITH OVAL KNOB.

499 1/2,	$1\frac{1}{2} \times 1$	inches, . . . . .	\$ .90
500 1/2,	$2\frac{1}{4} \times 1\frac{5}{8}$	" . . . . .	1.05
502 1/2,	$1\frac{3}{4} \times 1\frac{3}{4}$	" . . . . .	.90
1089 1/2,	$2 \times 2\frac{1}{4}$	" . . . . .	1.35

\* Also made in Iron, except No. 1089, which is made in Bronze or Brass only. For article on "Metals and Finishes" see page 595, and for Nomenclature of Finishes and Explanation of Finish Symbols see page 609.

See Note as to Method of Pricing, page 33. Cuts 1/4 Size.



## The Blount Door Check and Spring.

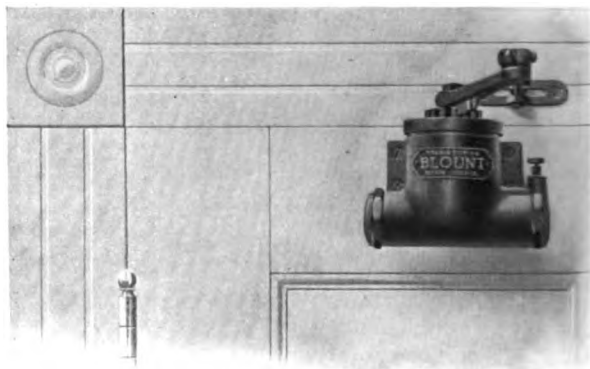

Fig. 1. Right-hand Door From Inside. Use Right-hand Check.

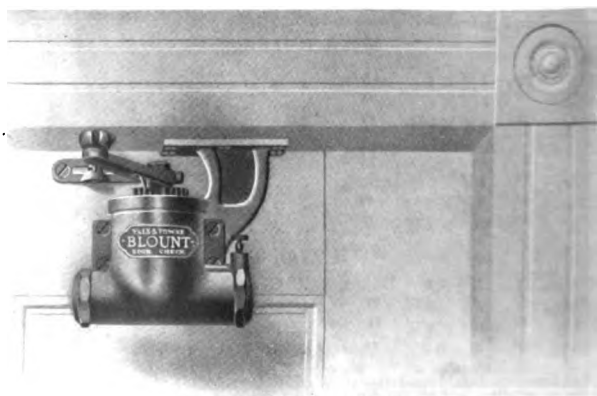
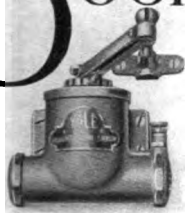

Fig. 2. Right-hand Door From Outside. Use Left-hand Check with Bracket.

## The Yale & Towne Blount Door Check and Spring.

**D** **DOOR** CHECKS applied on inner or hinge side of door are recommended wherever the conditions permit.



Select the illustration on opposite page, showing the position in which check is to be placed and the text will indicate the hand. State these facts and specify the size of check required in accordance with table

given below. It would be well also to give size and location of door.

For doors exposed to severe draughts use a check one size larger than called for in the table below.

Doors with metal frames or heavy glass panels require a heavier check than ordinary doors of equal size.

### SIZES AND PRICES.

Size.	Description.	Each.
1.	For very light doors, . . . . .	\$6.00
2.	For light inside doors, . . . . .	8.00
3.	For inside doors of medium size, . . . . .	10.00
4.	For heavy inside and ordinary outside doors, . . . . .	12.00
5.	For outside doors of medium size, . . . . .	16.00
6.	For heavy outside doors, . . . . .	20.00

Checks are furnished regularly in gold bronze.

*At the same price* (when so ordered, they will be supplied in silver bronze, or imitation of Bower-Barff.

*At an additional price* they will be furnished plated in brass, bronze, nickel, copper, oxidized silver, or any other finish desired, either polished or unpolished. Or in *solid* brass or bronze, if desired.

## The Yale & Towne Blount Door Check and Spring For Special Conditions.

### TO OPEN ALL THE WAY BACK:

When Checks are to be attached to Outside of doors—this is the side from which hinges cannot be seen (as shown in Fig. 2, page 786), and it is required to open doors all the way back (180 degrees), they will be furnished with an extra length of arm, in order to prevent the latter from hitting the bracket.

### FOR DOORS WITH FLUSH JAMBS:

When a Check is to be applied to the Soffit of the door by means of a bracket and the Soffit is not sufficiently wide to furnish a footing for the regular bracket, a flush bracket will be furnished, without additional charge.

### FOR ROUND TOP DOORS:

If the check is applied to the *door*, a suitable bracket will be furnished without additional charge. If applied to the *jamb*, a flush bracket as described above should be used. Brackets for Round Top Doors vary in accordance with the dimensions and radius of the door; therefore in specifying give the width of the door and the radius of top. State also the hand of door and whether it must open all the way back (180 degrees).

### FOR STORM OR SCREEN DOORS:

When the space between two doors is limited, as in the case of a storm or screen door, a check may be applied *between* the doors. The jamb bracket in such case is either screwed to the Side Jamb or Soffit of door frame. The closing power of a check so applied is not equal to that of a check regularly applied, and therefore with heavy doors an auxiliary spring should be used.



58



68

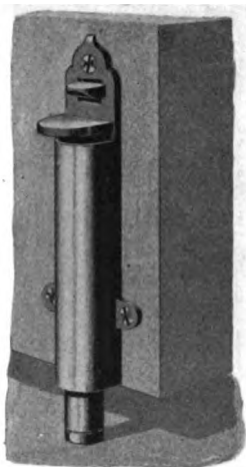

1125



901



900

Door Pulls and Stops.

Buffed Bronze or Brass.\*

No.		Each.
58,	Flat Front Flush Sliding Door Pull, Case, $3\frac{5}{8} \times 2\frac{1}{4} \times \frac{5}{8}$ ins; Front, $5\frac{3}{4} \times 1\frac{1}{4}$ inches. Reversible. Pull is thrown out by pressing plunger, . . . . .	\$2.65
78,	Same as No. 58, but with Astragal Front, . . . . .	8.00†
68,	Flat Front Flush Sliding Door Pull, Front, $5\frac{1}{2} \times 1\frac{1}{8}$ inches. Lower part of Pull is thrown out by pressing upper part, . . . . .	1.20
88,	Same as No. 68, but with Astragal Front, . . . . .	2.65†
900,	Flat Front Sliding Door Stop, $2\frac{3}{4} \times 1$ inches, . . . . .	.10
901,	Same as No. 900, but with Astragal Front, . . . . .	.10
1125,	Double Acting Spring Door Stop, Case, $6\frac{1}{2} \times 2\frac{1}{4} \times 1$ inches. Projection of Bolt when thrown, $1\frac{1}{4}$ inches, . . . . .	3.30

\*No. 1125 also made in Iron, and Nos. 900 and 901 made in Iron only: Bronze Plated. For article on "Metals and Finishes" see page 595, and for Nomenclature of Finishes and Explanation of Finish Symbols, see page 609.

†Priced set of 2.

See Note as to Method of Pricing, page 33. Cuts  $\frac{1}{4}$  Size.



1106



1112



1108

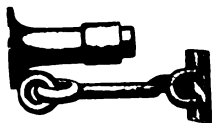

1109

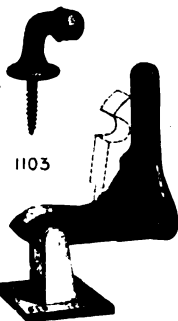

1103



1110



1112 1/2



1105

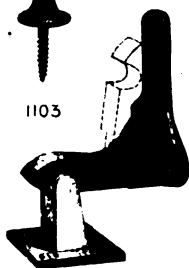

1104



1111

## Door Stops.

Buffed Bronze or Brass.\*

No.	Description	Each.
1103,	Height $1\frac{3}{8}$ inch, Base $1\frac{1}{8}$ inches, . . . . .	\$1.30
1104,	With Wood Screws. Height of Holder $3\frac{1}{2}$ inches, . . . . .	3.00
1105,	Length (inch rubber) $3\frac{1}{4}$ inches, Base $1\frac{1}{4}$ inches, . . . . .	1.30
1106,	With Wood Screws. Base $1\frac{3}{4} \times 2$ inches, Height $2\frac{7}{8}$ ins., . . . . .	8.75
1107,	With Wood Screws. Same as No. 1106, but with Drop Hook, . . . . .	9.60
1108,	With Wood Screws. Height (including rubber) 2 inches, . . . . .	9.00
1109,	With Wood Screws. Base $1\frac{3}{4}$ ins., made in various lengths, . . . . .	5.50
"	No Hook, $1\frac{1}{2}$ , 2, $2\frac{1}{4}$ , $2\frac{1}{2}$ inches, . . . . .	2.25
"	" 3, $3\frac{1}{2}$ , 4 inches, . . . . .	2.75
"	" 5, 6, 7 inches, . . . . .	3.25
1110,	With Wood Screws. $1\frac{1}{2} \times 2\frac{3}{8}$ inches, . . . . .	1.20

\* No. 1105 also made in Iron. Nos. 1106, 1107, 1108 and 1109 also furnished with Expansion Bolts at additional cost. No. 1109 Regularly furnished with  $2\frac{1}{2}$  inch Hooks; 3,  $3\frac{1}{2}$  and 4 inches supplied if specified.

See Note as to Method of Pricing, page 33. Cuts  $\frac{1}{4}$  Size.

Door Stops—(Continued.)

Buffed Bronze or Brass.\*

(Illustrated on opposite page.)

No.		Each.
1111,	With Bolts and Nuts. Height, 3 inches. Made for various thicknesses of marble as specified, . . . . .	\$3.75
1112,	"Duplex," for Double Acting Doors, $4 \times 2\frac{1}{2}$ inches, . . . . .	3.20
1112 $\frac{1}{2}$ ,	"Single," for Single Doors, $2\frac{1}{2} \times 2$ inches, . . . . .	2.10

Door Knobs.

For Plain Metal or Wood Door Knobs, see Part V, pages 708 and 709.

For Ornamental Door Knobs, see Part III, Section 3, pages 236 to 581.

Door Pulls.

For Plain and Ornamental Door Pulls, see Part VII, Sec. 1, pages 823 to 846.

Drawer Pulls.

For Plain and Ornamental Drawer Pulls, see Part VII, Section 22, pages 925 to 939.

Includes Druggist Drawer Pulls, with Card Frames, Flush Ring Pulls, etc.

Escutcheon Plates, Cup Escutcheons and Key Plates.

For Plain Escutcheon Plates, see Part V, Section 1, pages 704 and 705.

For Ornamental Escutcheon Plates, see Part III, Section 3, pages 236 to 581; also Part V, Section 2, pages 710 to 734.

For Plain Cup Escutcheons, see Part V, Section 1, pages 706 and 707.

For Ornamental Cup Escutcheons, see Part VII, Section 13, pages 904 to 915.

For Plain Key Plates, see Part V, Section 1, pages 704 and 705.

For Ornamental Key Plates, see Part VII, Section 26.

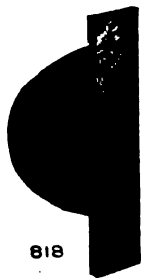

Frame Pulleys.

Front and Strike, Buffed Bronze or Brass.\*

Frame, Japanned Iron.

No.		Each.
818,	Front, $4\frac{5}{8} \times 1\frac{1}{8}$ ins. 2 in. Wheel.	\$1.00
819,	" $5\frac{3}{8} \times 1\frac{1}{4}$ " 2 $\frac{1}{4}$ " " "	1.10
820,	" $5\frac{1}{2} \times 1\frac{1}{4}$ " 2 $\frac{1}{2}$ " " "	1.25

\*For article on "Metals and Finishes" see page 595, and for Nomenclature of Finishes and Explanation of Finish Symbols see page 609.

## Card Frames.

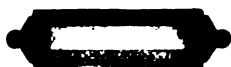

915



919

No.	Size.	For Card.	Each.*
915,	$1\frac{1}{8} \times 4\frac{1}{2}$ ins.,	$\frac{1}{2} \times 2\frac{1}{2}$ ins.,	\$ .25
916,	$1\frac{1}{4} \times 2$ "	$1 \times 1\frac{3}{4}$ "	.20
917,	$1\frac{1}{8} \times 2\frac{3}{4}$ "	$1 \times 2\frac{1}{4}$ "	.25
918,	$1\frac{1}{4} \times 3\frac{1}{4}$ "	$1\frac{1}{8} \times 2\frac{7}{8}$ "	.30
919,	$1\frac{7}{8} \times 3\frac{1}{2}$ "	$1\frac{5}{8} \times 3$ "	.35



7



8



9



10



1



4



5

## T-Handles and Thumb-Pieces.

## T-HANDLES AND PLATES.

No.		Each.*
7,	Plate $2 \times \frac{3}{4}$ inches, Handle, $1\frac{1}{8}$ inches, . . . . .	\$ .80
8,	" $2 \times 1\frac{1}{16}$ " " $1\frac{3}{4}$ " . . . . .	.80
9,	" " " " $1\frac{7}{8}$ " . . . . .	.90
10,	" $2\frac{1}{2} \times 1\frac{1}{4}$ " " $2\frac{1}{4}$ " . . . . .	1.10

## THUMB-PIECES AND PLATES.

1,	Rose $1\frac{1}{8}$ inches, Thumb-piece $1\frac{1}{8}$ inches, . . . . .	\$ .30
4,	Plate $2\frac{1}{4} \times 1\frac{1}{4}$ inches, " " $1\frac{3}{4}$ " . . . . .	.80
5,	" $1\frac{7}{8} \times 1\frac{1}{8}$ " " " $1\frac{3}{8}$ " . . . . .	.50

\* Buffed, Bronze or Brass. Card Frames also made in Iron. For article on "Metals and Finishes" see page 595, and for Nomenclature of Finishes and Explanation of Finish Symbols see page 609.

See Note as to Method of Pricing, page 33. Cuts  $\frac{1}{4}$  Size.

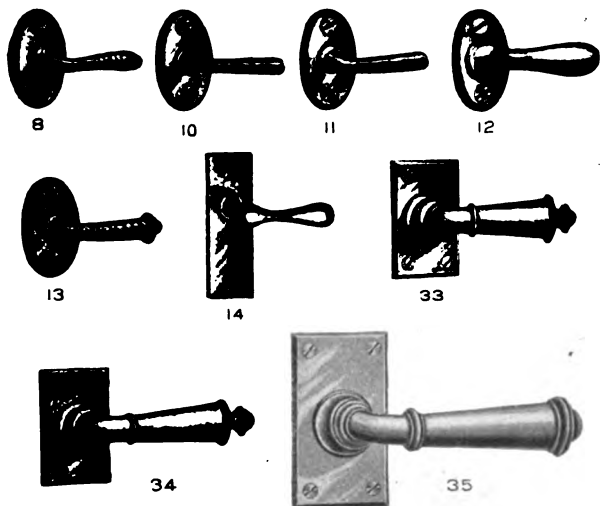

## Lever Handles and Plates.

Plate, 2	$\times 1\frac{1}{8}$ inches.	Handle, $1\frac{3}{4}$ inches,	Each *
"	"	"	\$ .90
"	"	"	.90
"	"	"	.90
"	"	"	1.55
"	"	"	1.00
"	3 $\times$ 1	"	.90
"	$2\frac{1}{2} \times 1\frac{5}{8}$	"	2.20
"	$2\frac{1}{2} \times 1\frac{5}{8}$	"	3.30
"	$3\frac{1}{2} \times 3$	"	5.50

Auxiliary Spring Attachment for Lever Handles,  
to Prevent Sagging of Handle.

The case contains a coiled steel spring which is compressed by the retraction of the latch bolt by the lever handle. When the latter is released it returns to its normal position, thus relieving the lock hub spring.

Additional Price, . . . . . each, \$1.10

\* Buffed Bronze or Brass. For article on "Metals and Finishes" see page 595, and for Nomenclature of Finishes and Explanation of Finish Symbols see page 609.

See Note as to Method of Pricing, page 33. Cuts  $\frac{1}{4}$  Size.



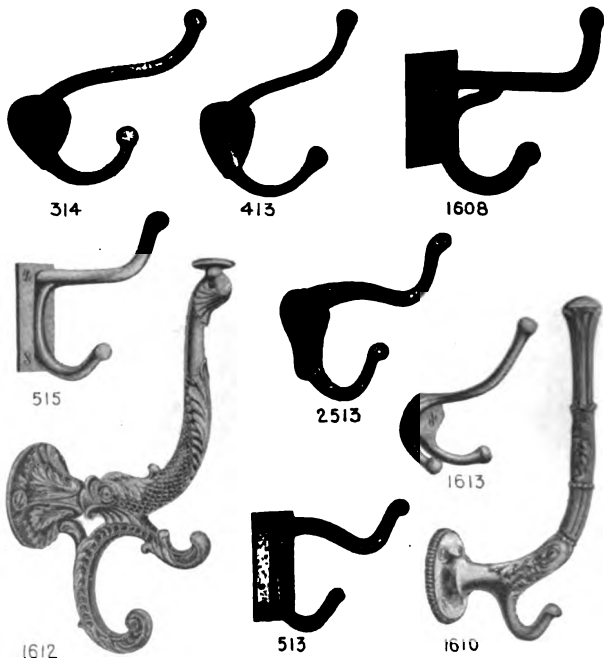

## Coat, Hat and Hall Tree Hooks.

No.	HALL TREE HOOKS.	Each.
1610,	Projection of upper Hook, $5\frac{1}{2}$ inches, . . . . .	\$5.00
1612,	" " " " $4\frac{3}{8}$ " . . . . .	4.00
COAT AND HAT HOOKS.		
314,	Projection of upper Hook, $3\frac{1}{4}$ inches, . . . . .	\$1.00
413,	" " " " $3\frac{1}{8}$ " . . . . .	.75
513,	" " " " $3\frac{1}{4}$ " . . . . .	.85
515,	" " " " $3\frac{1}{8}$ " . . . . .	.85
1608,	" " " " 4 " . . . . .	.75

\* In Buffed Brass or Bronze. Nos. 413 and 1612 also made in Iron. For article of "Metals and Finishes" see page 595, and for Nomenclature of Finishes and Explanation of Finish Symbols see page 609.

See Note as to Method of Pricing, page 33. Cuts  $\frac{1}{4}$  Size.

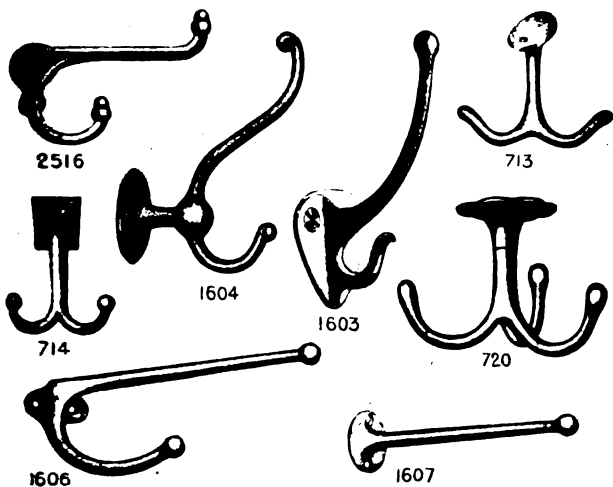

Coat, Hat, Ceiling and Towel Hooks.

COAT AND HAT HOOKS.

No.		Each.*
603,	Projection of upper Hook, 3 inches,	\$1.85
604,	" " " " 4 "	1.10
613,†	" " " " 2 "	.55
513,†	" " " " 3 1/4 "	.15
516,	" " " " 3 1/2 "	.05

CEILING HOOKS.

713,	Length of Hook 2 3/8 inches,	\$ .50
714,	" " " " 2 1/8 "	.55
720,‡	" " " " 3 "	1.40

TOWEL HOOKS.

1606,	Projection of upper Hook, 5 1/2 inches,	\$ .85
1607,	" " " " 4 1/2 "	.65

\* In Buffed Brass or Bronze. No. 713 also made in Iron. Nos. 2513 and 2516 made in Iron only. For article on "Metals and Finishes" see page 595, and for nomenclature of Finishes and Explanation of Finish Symbols see page 609.

† Illustrated on opposite page. ‡ Revolving Ceiling Hook.

See Note as to Method of Pricing, page 33. Cuts 1/4 Size.

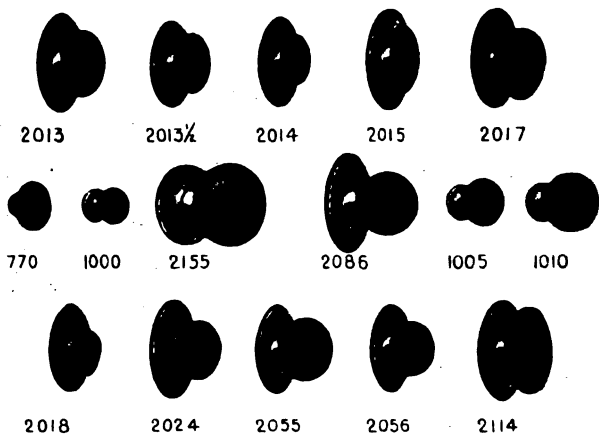

### Thumb, Shutter and Drawer Knobs.

#### THUMB-KNOBS AND PLATES.†

No.	Dimensions	Each.*	No.	Dimensions	Each.*
2013,	$1\frac{3}{8} \times \frac{7}{8}$ inches,	\$1.35	2017,	$1\frac{3}{8} \times 1$ inches,	\$1.40
2013½,	$1\frac{1}{4} \times \frac{3}{4}$ "	1.20	2018,	$1 \times \frac{5}{8}$ "	1.10
2014,	$1 \times \frac{5}{8}$ "	1.10	2055,	$1\frac{1}{4} \times 1\frac{1}{4}$ "	1.20
2015,	$1\frac{3}{8} \times \frac{3}{4}$ "	1.20	2056,	$1\frac{1}{8} \times 1\frac{1}{8}$ "	1.20
2114,	$1\frac{3}{4} \times \frac{7}{8}$ "	.80	2155,	$1\frac{3}{4} \times 1\frac{3}{4}$ "	1.10
2024,	$1\frac{1}{4} \times 1\frac{1}{4}$ "	1.20			

#### SHUTTER KNOBS.

770,	$1 \times 1$ inches,	\$ .30	1310,	$1\frac{1}{4} \times 1\frac{1}{4}$ inches,	\$ .40
1300,	$\frac{3}{4} \times \frac{3}{4}$ "	.25	771,	$1\frac{1}{8} \times \frac{5}{8}$ "	.35
1305,	$1 \times 1$ "	.30			

#### DRAWER KNOBS.

1000,	$\frac{3}{4} \times \frac{3}{4}$ inches,	\$ .30	1010,	$1\frac{1}{4} \times 1\frac{1}{4}$ inches,	\$ .45
1005,	$1 \times 1$ "	.35	1771,	$1\frac{1}{8} \times \frac{5}{8}$ "	.40

\* In Buffed Brass or Bronze. For article on "Metals and Finishes" see page 595. and for Nomenclature of Finishes and Explanation of Finish Symbols see page 609.

† With Solid Spindles: Specify Size of Spindle,  $\frac{3}{16}$ ,  $\frac{1}{4}$  or  $\frac{5}{16}$ .

See Note as to Method of Pricing, page 33. Cuts  $\frac{1}{4}$  Size.

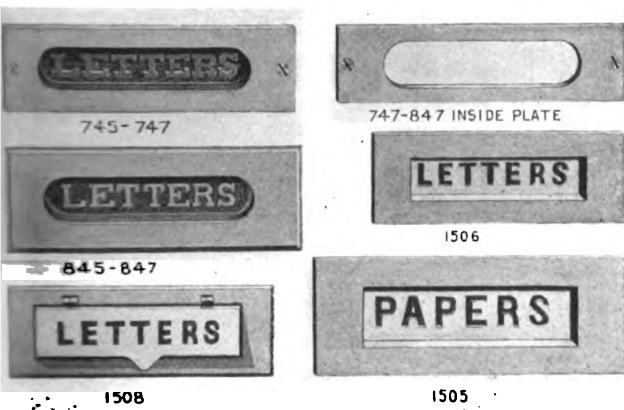

Letter Hole Plates.

Buffed Bronze or Brass.\*

No.		Size	Each.
745,†	Front only,	2 × 7 inches,	\$1.85
747,†	With Inside Plate,	" " "	2.50
749,†	" Hood,	" " "	3.65
845,	Front only,	2 1/2 × 7 "	2.25
847,	With Inside Plate,	" " "	2.85
849,	" Hood,	" " "	4.00
1505,	Front only,	3 × 7 7/8 "	4.00
1505 1/2,	With Inside Plate,	" " "	5.25
1506,	Front only,	2 1/4 × 6 1/8 "	2.00
1506 1/2,	With Inside Plate,	" " "	2.60
1507,	" Hood,	" " "	4.00
1508,	Front only,	" " "	2.25
1508 1/2,	With Inside Plate,	" " "	2.85

\*In Buffed Brass or Bronze. For article on "Metals and Finishes" see page 595, and for Nomenclature of Finishes and Explanation of Finish Symbols see page 609.

† Also made in Iron.

See Note as to Method of Pricing, page 33. Cuts 1/4 Size.



32 No. 1-P Club Letter Boxes.

### Yale Letter Boxes

For Clubs and Office Buildings.

The above illustration shows a nest of boxes with roundabout as regularly furnished.

For further details see below and opposite page.

**WOOD.**—The partitions and roundabout are made of white wood, and the prices on next page cover the fronts and woodwork, but do not include mouldings or panels which should be used to cover the white wood roundabout when the fronts of the boxes are not set in flush with the face of the wall. These mouldings and panels can be furnished with the boxes, if desired, at an additional price. The rear of the boxes is closed by a white wood back.

**KEYS.**—Three Paracentric Keys No. 8 are furnished with each box. Keys will not be duplicated by number or drawing, but one of the original keys is required. If they are all lost the tumbler case (or cylinder) of the lock, or the front of the box itself, must be returned. If wanted reset to the original key the lock must be accompanied by one of the latter; otherwise it will be reset to a new combination.

**NUMBERING.**—Boxes can be numbered as desired at an additional price of five cents each net.

**GLASS.**—Heavy beveled plate glass is used in the fronts.

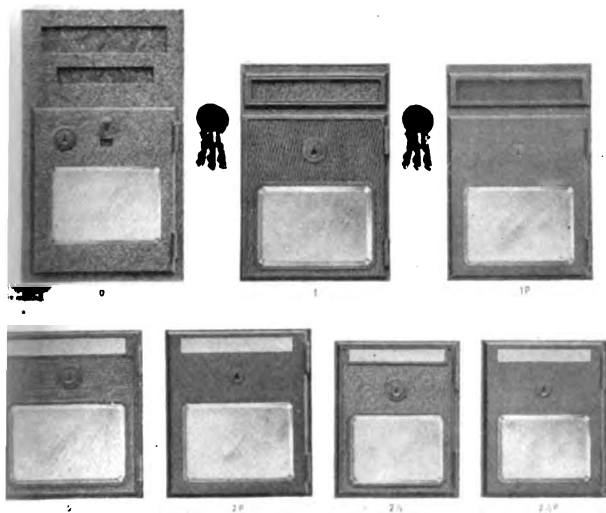

Yale Letter Boxes.

For Clubs and Office Buildings.

Buffed Bronze or Brass.\*

	Each.
0, Inside size, 10 × 5½ × 10 inches, . . . . .	\$20.00
1, " " 7¾ × 5 × 10 " . . . . .	14.50
1P, " " 5¾ × 5 × 10 " . . . . .	11.75
2, " " 5½ × 4¼ × 10 " . . . . .	11.25

\*Also furnished with Ornamental Front, as in Nos. 0, 1, 2 and 2½ at same price. May be had in a variety of finishes to harmonize with other hardware or with the work of the room. For articles on "Metals and Finishes" see page 595, and for nomenclature of Finishes and Explanation of Finish Symbols see page 609.

See Note as to Method of Pricing, page 33. Cuts ¼ Size.





**Yale  
Hallway Letter Boxes.**

These boxes are intended for use in hallways of Office Buildings, Apartment Houses, etc.

Box of Solid Bronze, with two Yale corrugated keys.

		Buffed Bronze.*	
No			Each.
2,	Depth, 3 inches; Width, 7 inches; Height, 11 inches,		\$15.50
3,	Depth, 2 inches; Width, 5 inches; Height, 8 inches,		8.50

**Figures and Letters.**

For Plain and Ornamental Figures see Part VII, Section 10, pages 880 to 884.

For Plain and Ornamental Letters see Part VII, Section 11, pages 885 and 886.

**Kick Plates.**

		Per 100 sq. Inches.
Polished or unpolished Bronze.*		
Not larger than 12×48 inches, Without offsets,	$\left\{ \begin{array}{l} \frac{1}{16} \\ \frac{1}{10} \end{array} \right.$	inch thick, . . . . . \$3.75
		“ “ . . . . . 5.30
Larger than 12×48 inches, Without offsets,	$\left\{ \begin{array}{l} \frac{1}{8} \\ \frac{1}{10} \end{array} \right.$	“ “ . . . . . 6.25
		“ “ . . . . . 4.75
	$\left\{ \begin{array}{l} \frac{1}{10} \\ \frac{1}{8} \end{array} \right.$	“ “ . . . . . 6.75
		“ “ . . . . . 8.00

For Ornamental Kick Plates, see pages 870 and 871.

**Push Buttons.**

For Plain and Ornamental Push Buttons see Part VII, Section 13, pages 895 to 903.

\* Also made in Japanned and Bronzed Iron. For article on “Metals and Finishes” see page 595, and for Nomenclature of Finishes and Explanation of Finish Symbols see page 609.

See Note as to Method of Pricing, page 33. Cuts ¼ Size.





2



3



4

## Push Plates.

Buffed Bronze or Brass.\*

Round Corners and Round Edges (Fig. 1).

## CAST BRONZE.

Size.	Each.	Size.	Each.
8½ × 2½ inches,	\$1.65	12 × 2½ inches,	\$3.75
9 × 2½ "	1.75	12 × 4 "	4.25
9¾ × 2¾ "	2.10	13¼ × 2¾ "	2.50
10 × 3 "	2.35	14 × 3¼ "	4.00
11 × 3 "	2.55	16 × 4 "	5.75
11 × 3½ "	3.40	19¾ × 4 "	7.00

## WROUGHT BRONZE—REVERSED.

10 × 2¾ inches,	1.10
-----------------	------

\* Wrought Bronze Plate is also made in Steel. For article on "Metals and Finishes" see page 595, and for Nomenclature of Finishes and Explanation of Finish Symbols see page 609.

See Note as to Method of Pricing, page 53. Cuts ¼ Size.

Push Plates—Continued.

Buffed Bronze or Brass.\*

Square Corners and Beveled Edges (Fig. 4).

CAST BRONZE.

Size.	Each.	Size.	Each.
2×3 inches,	\$2.35	18×4 inches,	\$6.35
1×3 " "	2.55	20×4 " "	7.00
2×3 " "	2.80	24×4 " "	8.50
4×3 1/2 " "	4.30	24×5 " "	10.60
5×4 " "	5.75		

Also furnished in 27 irregular sizes, from 10×2 1/2 inches up to 28 1/4 × 3 1/4 inches.

WITH LETTERING.

3×2 inches, with "Push," Fig. 2,			\$ .50
3×2 " " "Pull," " 3,			.50
1×3 " " "Push,"			2.55
4×3 1/4 " " " "			4.00
6×4 " " " "			5.75
4×4 1/2 " " " "			9.50

Also furnished in 8 irregular sizes, from 8×3 up to 32×4 inches.

WROUGHT BRONZE (SOLID ROLLED).

Size.	Each.	Size.	Each.
10×3 inches,	\$1.35	18×3 1/2 inches,	\$2.80
12×3 " "	1.60	12×4 " "	2.10
15×3 " "	2.00	16×4 " "	2.80
12×3 1/2 " "	1.85	18×4 " "	3.25
15×3 1/2 " "	2.35	24×4 " "	4.25

\*Cast Bronze, also made in Iron and Wrought Bronze; also made in Steel. For article on "Metals and Finishes" see page 595, and for Nomenclature of Finishes and Explanation of Finish Symbols see page 609.

See Note as to Method of Pricing, page 33. Cuts 1/4 Size.

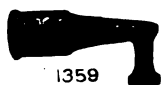

1359



1358



400



1354



1352



1353



410



412

## Sash Hooks and Sockets.

Buffed Bronze or Brass.\*

No.	SASH HOOKS.	Each
1358, 3 inch,	. . . . .	\$ .85
1359, 3 "	. . . . .	1.00

No.	SASH SOCKETS.	Each
412, Rim, 1 × 2 inches,	. . . . .	.15
410, " 1 1/8 " (Round),	. . . . .	.15
400, " 1 3/8 × 2 3/8 "	. . . . .	.35
1352, " 2 × 3 "	. . . . .	.60
1353, Mortise case, 1 3/4 × 1 7/8 × 1/2 inches,	. . . . .	2.65
1354, Flush Rim case, 1 3/4 × 2 7/8 × 1/2 inches,	. . . . .	2.65

\*Nos. 1358, 400, 410 and 412 also made in Iron. For article on "Metals and Finishes" see page 595, and for Nomenclature of Finishes and Explanation of Finish Symbols see page 609.

See Note as to Method of Pricing, page 33. Cuts 1/4 Size.

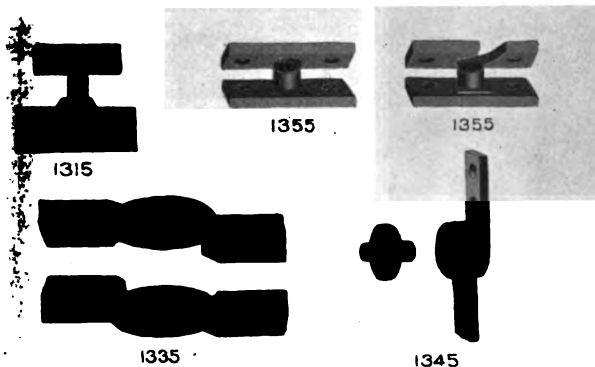

Sash Centers.

Buffed Bronze or Brass.\*

FOR VERTICAL SWING.

	Set.
35, 14 sizes, from $\frac{1}{2} \times 4 \times 1\frac{1}{2}$ inches up to $\frac{1}{2} \times 5 \times 3\frac{1}{8}$	
inches, . . . . .	from \$4.50 to \$11.00

FOR HORIZONTAL SWING.

55, $\frac{1}{4} \times 2\frac{5}{8} \times 1\frac{3}{8}$ inches, . . . . .	3.00
---	------

FOR TRANSOMS.

45, $4 \times 1\frac{1}{4}$ inches, . . . . .	2.25
15, Plate, $2\frac{3}{8} \times \frac{7}{8}$ inches; Pivot Plate, $1\frac{3}{4} \times \frac{3}{4}$ inches, . . . . .	.35

\* No. 1315 is made in Iron only. For article on "Metals and Finishes" see page 595, for Nomenclature of Finishes and Explanation of Finish Symbols see page 600.

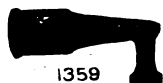

1359



1358



400



1354



1352



1353



410



412

## Sash Hooks and Sockets.

Buffed Bronze or Brass.\*

## SASH HOOKS.

No.	Size	Price
1358, 3 inch,	. . . . .	5.50
1359, 3 "	. . . . .	4.50

## SASH SOCKETS.

412, Rim, 1×2 inches,	. . . . .	1.00
410, " 1 1/8 " (Round),	. . . . .	1.00
400, " 1 3/8×2 3/8 " "	. . . . .	1.00
1352, " 2×3 " "	. . . . .	1.00
1353, Mortise case 1 3/4×1 1/4 "	. . . . .	1.00
1354, Flush P.	. . . . .	1.00

\*Nos. 1358  
 inches " se  
 Symbol



1315



1355



1355



1335



1345

Sash Centers.

Buffed Bronze or Brass. †

FOR VERTICAL SWING.

5, 14 sizes, from  $\frac{1}{2} \times 4 \times 1\frac{1}{2}$  inches up to  $\frac{3}{2} \times 5 \times 3\frac{1}{2}$  inches, . . . . .

	Each.
	\$ .90
	.90
5, 14	1.65
	1.25
	2.25
	lifts.
	\$ .20

6, 1390 also made in Steel.  
for Nomenclature of Finishes

35 33- Cuts 14 Size.

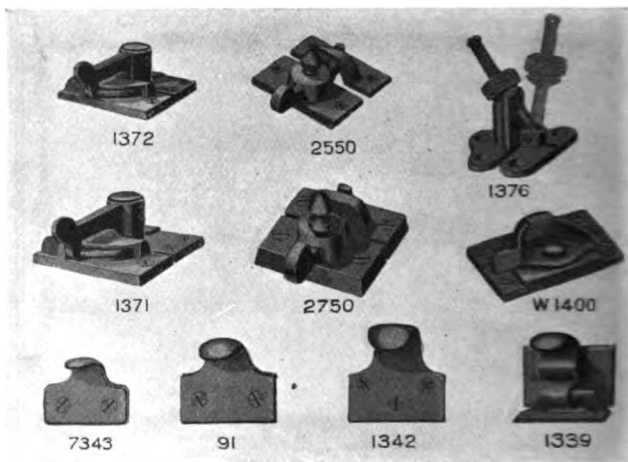

## Sash Fast and Lifts.

Buffed Bronze or Brass.\*

No.	SASH FASTS.		Pr.
1371, Self-locking,	$1\frac{1}{8} \times 2\frac{5}{8}$	inches,	\$1.75
1372, " "	$1 \times 2\frac{1}{4}$	" "	1.25
2550, . . . . .	$1\frac{1}{8} \times 2\frac{1}{4}$	" "	.50
2750, . . . . .	$1\frac{1}{4} \times 2\frac{7}{8}$	" "	1.20
1376, Yale Screw,	$2\frac{1}{2} \times 2\frac{1}{8}$	" "	1.75
W1400, Vulcan,	$2\frac{3}{4} \times 1\frac{3}{4}$	" "	.75
HOOK SASH LIFTS.			
W7343, Wrought,	$1\frac{1}{4} \times 1\frac{3}{4}$	inches,	1.00
W5343, " "	$1\frac{3}{8} \times 1\frac{3}{4}$	" "	.70
84, Cast,	$1\frac{1}{2} \times 1\frac{3}{4}$	" "	.55
91, " "	$2 \times 1\frac{3}{4}$	" "	.55
1342, " "	$1 \times 2$	" "	.50
1339, " "	$1\frac{3}{4} \times 1\frac{7}{8}$	" (with locking device),	1.75

\*Nos. 1371 and 1372 also made in Iron; Nos. 1376, W1400, 7343 and 5343 also made in Steel. Nos. 2550 and 2750 made in Iron only. For article on "Metals and Finishes" see page 595, and for Nomenclature of Finishes and Explanation of Finish Symbols see page 609.

See Note as to Method of Pricing, page 33. Cuts  $\frac{1}{4}$  Size.

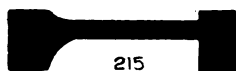

215

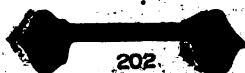

202

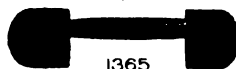

1365



201

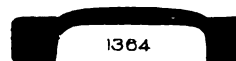

1364

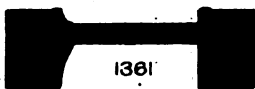

1361

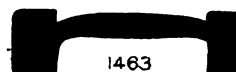

1463

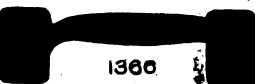

1366

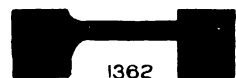

1362

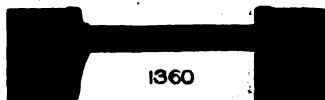

1360

## Bar Sash Lifts.

Buffed Bronze or Brass.\*

No.	Size.	Each.	No.	Size.	Each.
215,	1 1/4 x 5 inches,	.80	202,	1 1/2 x 5 inches,	.90
365,	1 1/4 x 5 "	1.55	201,	1 1/2 x 5 1/4 "	.90
364,	1 1/4 x 5 1/8 "	.90	1361,	1 3/4 x 5 1/2 "	1.65
463,	1 3/8 x 5 1/8 "	.90	1366,	1 3/4 x 5 5/8 "	1.25
1362,	1 1/2 x 4 3/4 "	1.10	1360,	2 x 7 "	2.25

## Rim Sash Lifts.



1390

No.

1390, 1 1/4 x 3 inches. . . . . \$ .20

\*Nos. 215, 1364, 1366 and 1463 also made in Iron; No. 1390 also made in Steel. For article on "Metals and Finishes" see page 595, and for Nomenclature of Finishes and Explanation of Finish Symbols see page 609.

See Note as to Method of Pricing, page 33. Cuts 1/4 Size.





2095



W7349



W1324



1325

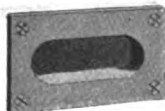

1349

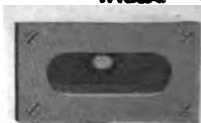

1349 L



71349

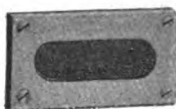

1349 B



W5349

## Flush Sash Lifts.

Buffed Bronze or Brass.\*

No.					Each.
W1324,	Wrought,	Straight Edge,	$1\frac{3}{8} \times 2\frac{7}{8}$ inches,		\$ .15
W7349,	"	Round,	$1\frac{1}{2} \times 3$	"	.15
W5349,	"	Beveled,	$1\frac{1}{2} \times 3\frac{1}{4}$	"	.15
1347,	Cast,	Straight	$1\frac{1}{4} \times 3$	"	.40
1344,	"	"	$1\frac{1}{2} \times 3$	"	.40
1344L,	"	"	$1\frac{1}{2} \times 3$	"	1.75
2100,	"	"	$1\frac{3}{4} \times 3$	"	.20
1325,	"	"	$1\frac{7}{8} \times 4\frac{1}{8}$	"	1.35
1349,	"	"	$2 \times 3\frac{1}{2}$	"	.70
1349L,	"	"	$2 \times 3\frac{1}{2}$	"	2.00
71347,	"	Round	$1\frac{1}{4} \times 3$	"	.50
71344,	"	"	$1\frac{1}{2} \times 3\frac{1}{4}$	"	.50
71349,	"	"	$2 \times 3\frac{1}{2}$	"	.80
1347B,	"	Beveled,	$1\frac{1}{4} \times 3$	"	.50
1344B,	"	"	$1\frac{1}{2} \times 3$	"	.50
2095,	"	"	$1\frac{3}{4} \times 3$	"	.20
1349B,	"	"	$2 \times 3\frac{1}{2}$	"	.70

\* Nos. W1324, W7349 and W5349 also made in Steel. Nos. 2100 and 2095 made in Iron only. For article on "Metals and Finishes" see page 595, and for Nomenclature of Finishes and Explanation of Finish Symbols see page 609.

See Note as to Method of Pricing, page 33. Cuts  $\frac{1}{4}$  Size.

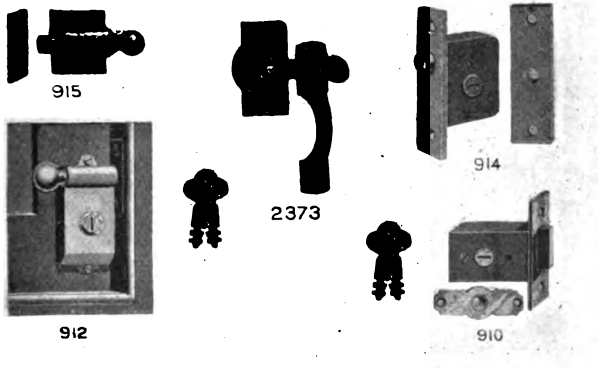

Sash Bolts, Fasteners and Locks.

Buffed Bronze or Brass.\*

SASH SPRING BOLT.

No.		Each.
915,	1 1/4 x 1 1/8 inches, . . . . .	\$ .70

CELLAR SASH FASTENER.

373,	Plate, 1/4 x 2 inches, . . . . .	.20
------	----------------------------------	-----

SASH SPRING LOCK.

912,	Rim Case, 2 1/2 x 1 inches, . . . . .	2.25
914,	Mortise Case, 1 3/4 x 1 1/4 " Backset, 1/4 inch, . . . . .	2.00

SASH DEAD LOCK.

910,	Mortise Case, 1 1/8 x 1 7/8 inches. Backset, 1 1/8 inches, . . . . .	2.50
------	--	------

\*No. 2373 made in Iron only. For article on "Metals and Finishes" see page 95, and for Nomenclature of Finishes and Explanation of Finish Symbols see page 609.

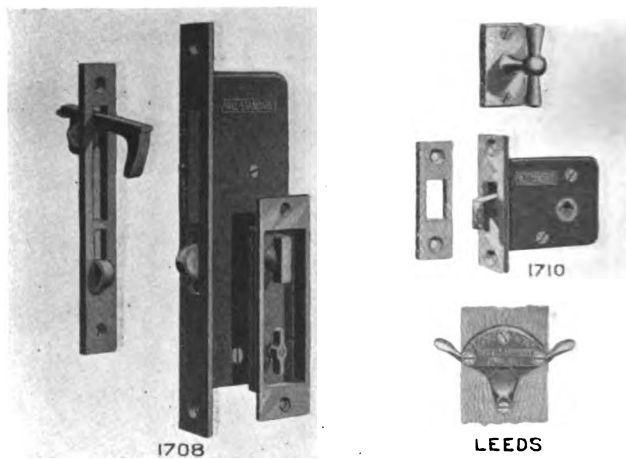

### Sliding Door Latches and the Leeds Gate Fixtures.

No.	SHUTTER OR SLIDING DOOR LATCH.	Set.*
1708,	Case, $6\frac{1}{2} \times 2\frac{1}{8} \times \frac{5}{8}$ ins., for doors which slide flush,	\$2.00
"	" " " " " " for doors which do not slide flush,	2.50

**OPERATED.**—Latch Bolt by Thumb-piece from one or both sides. Dead-locked by Key. Latch spring-catches when Shutter is closed, then by a one-quarter turn of Thumb-piece the Shutter is drawn tight up against the jamb.

No.	SLIDING DOOR LATCH.	Set.*
1710,	Case, $1\frac{7}{8} \times 2\frac{1}{4} \times \frac{1}{2}$ ins., for doors which slide flush,	\$ .70
"	" " " " " " for doors which do not slide flush,	1.15

**OPERATED.**—By Thumb-piece from one or both sides. Shutter or Door is drawn tight against jamb by an additional quarter-turn of Thumb-piece, see No. 1708 above.

#### LEEDS GATE FIXTURES.

Complete Fixtures consist of Front Plate, Back Plate, Thumb-pieces, Each.\*  
Strike, Hook, Staple, Post Hinge, Gate Hinge, Nut and Washer, . \$1.50

\* Latches, Buffed Bronze or Brass; Gate Fixtures, Japanned Iron. For article on "Metals and Finishes" see page 595, and for Nomenclature of Finishes and Explanation of Finish Symbols see page 609.

See Note as to Method of Pricing, page 53. Cuts  $\frac{1}{4}$  Size.



TREASURER



BILL CLERK

## Signs.

Buffed Bronze or Brass.\*

Lettering.	Size.	Each.
Bill Clerk, . . . . .	2 <sup>1</sup> / <sub>4</sub> × 10 inches,	\$3.30
Bookkeeper, . . . . .	2 <sup>1</sup> / <sub>4</sub> × 12 "	4.35
Cashier, . . . . .	2 <sup>1</sup> / <sub>4</sub> × 8 "	2.65
" . . . . .	2 <sup>1</sup> / <sub>4</sub> × 12 "	3.75
Entrance, . . . . .	2 <sup>1</sup> / <sub>4</sub> × 12 "	4.00
General, . . . . .	1 <sup>1</sup> / <sub>2</sub> × 6 <sup>3</sup> / <sub>4</sub> "	2.40
" . . . . .	1 <sup>1</sup> / <sub>2</sub> × 8 <sup>1</sup> / <sub>2</sub> "	2.60
Inquiry, . . . . .	2 <sup>1</sup> / <sub>4</sub> × 12 "	3.75
Ladies, . . . . .	2 <sup>1</sup> / <sub>4</sub> × 8 "	2.40
No Admittance, . . . . .	2 <sup>1</sup> / <sub>4</sub> × 12 "	4.75
Office, . . . . .	3 <sup>1</sup> / <sub>2</sub> × 14 "	5.75
Packages, . . . . .	2 <sup>1</sup> / <sub>4</sub> × 12 "	4.00
President, . . . . .	2 <sup>1</sup> / <sub>4</sub> × 12 "	4.25
Private, . . . . .	2 <sup>1</sup> / <sub>4</sub> × 7 <sup>1</sup> / <sub>2</sub> "	3.00
" . . . . .	2 <sup>1</sup> / <sub>4</sub> × 12 "	3.75
Secretary, . . . . .	2 <sup>1</sup> / <sub>4</sub> × 12 "	4.25
Special, . . . . .	1 <sup>1</sup> / <sub>2</sub> × 6 <sup>3</sup> / <sub>4</sub> "	2.40
Superintendent, . . . . .	2 <sup>1</sup> / <sub>4</sub> × 12 "	5.25
Superintendent's Office, . . . . .	3 <sup>1</sup> / <sub>4</sub> × 13 "	9.25
Teller, . . . . .	2 <sup>1</sup> / <sub>4</sub> × 8 "	2.40

\* For article on "Metals and Finishes" see page 595, and for Nomenclature of Finishes and Explanation of Finish Symbols see page 609.

See Note as to Method of Pricing, page 33. Cuts <sup>1</sup>/<sub>4</sub> Size.



W230



1382



1385



1383



1384

## Shutter Bars.

Buffed Bronze or Brass.\*

No.				Each.
1383,	Rim, Wrought,	$1\frac{3}{4} \times 1\frac{7}{8}$ inches,	.	\$ .60
1384,	" "	$1\frac{3}{4} \times 2\frac{1}{2}$ "	.	.60
W230,	" "	$2 \times 2$ "	.	.50
1381,	" Cast,	$1\frac{3}{4} \times 1\frac{3}{4}$ "	.	1.00
1382,	" "	$2 \times 1\frac{1}{8}$ "	.	1.00
1385,	Flush, "	$3\frac{5}{8} \times 2$ "	.	2.75



1330



1333



1332



## Transom Chains.

Buffed Bronze or Brass.\*

No.				Each
1333,	Plate, $1\frac{3}{8} \times \frac{1}{2}$ inches;	chain 12 inches,†	.	\$1.00
1330,	" $1\frac{1}{2} \times \frac{3}{4}$ "	" " 9 "	.	1.00
1332,	" $1\frac{3}{4} \times 1\frac{1}{4}$ "	" " 12 "	.	1.35

\* Nos. 1330, 1332 and 1333 also made in Steel. For article on "Metals and Finishes" see page 595, and for Nomenclature of Finishes and Explanation of Finish Symbols see page 609.

† May be had with other lengths of chain

See Note as to Method of Pricing, page 33. Cuts  $\frac{1}{4}$  Size.



**Yale & Towne Transom Lifters.**

On page 193 will be found article on Transom Lifters, which gives detailed description and illustration of Transom Lifters.

For illustrations of Top, Center and Bottom hung Transoms see next page ; and page 815 for list of sizes, finishes and prices.

To find correct length of any style of Lifter wanted, deduct 4 feet from the distance between the floor and the center of Transom.

Where practicable it is well to furnish with orders for Special Lifters, not covered by list of regular goods on page 815, drawings or tracings showing horizontal cross section of transom and door casing.



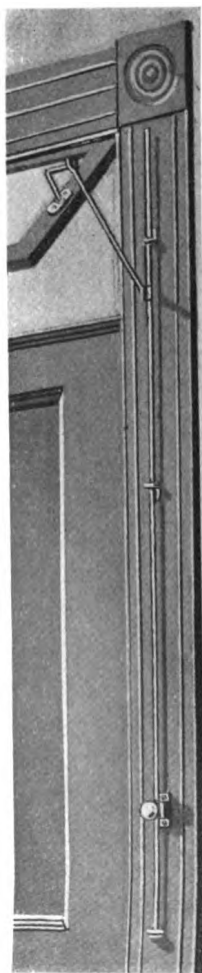

Fig. 1. Top Hung.

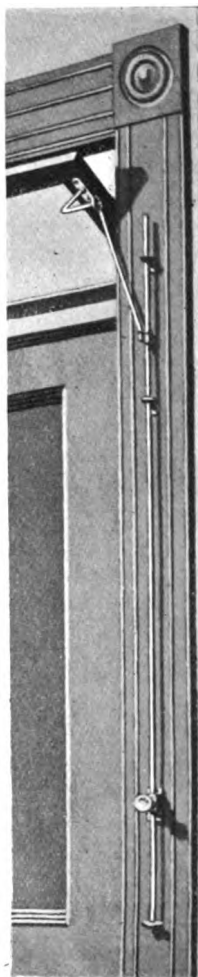

Fig. 2. Center Hung.



Fig. 3. Bottom Hung.

**Types of Transom Lifters.**

Sizes, Prices and Finishes.

Plated Finishes on Steel, Polished. Bronze, Brass, Old Copper, Old Brass and Nickel.

FOR TOP OR CENTER HUNG TRANSOMS.

No.	Rod.	Length.	Each *	No.	Rod.	Length.	Each.*
S543,	$\frac{1}{4}$ inch,	3 feet,	.95	S556,	$\frac{1}{2}$ inch,	6 feet,	\$1.80
S544,	"	4 "	1.00	S565,	$\frac{3}{8}$ inch,	5 "	2.25
S553,	$\frac{5}{16}$ inch,	3 "	1.35	S566,	"	6 "	2.50
S554,	"	4 "	1.55	S567,	"	7 "	2.80
S555,	"	5 "	1.65	S568,	"	8 "	3.00

FOR BOTTOM HUNG TRANSOMS.

S643,	$\frac{1}{4}$ inch,	3 feet,	\$1.05	S656,	$\frac{5}{16}$ inch,	6 feet,	2.00
S644,	"	4 "	1.20	S665,	$\frac{3}{8}$ inch,	5 "	2.50
S653,	$\frac{5}{16}$ inch,	3 "	1.55	S666,	"	6 "	2.75
S654,	"	4 "	1.75	S667,	"	7 "	3.00
S655,	"	5 "	1.85	S668,	"	8 "	3.25
Additional Rod,	$\frac{1}{8}$ or $\frac{1}{4}$ inch,					per foot,	.30
"	"	$\frac{3}{8}$ inch,				"	.45

Solid Bronze or Brass.†

FOR TOP OR CENTER HUNG TRANSOMS.

No.	Rod.	Length.	Each.*	No.	Rod.	Length.	Each.*
B143,	$\frac{1}{4}$ inch,	3 feet,	\$2.65	B156,	$\frac{1}{2}$ inch,	6 feet,	\$4.85
B144,	"	4 "	2.90	B165,	$\frac{3}{8}$ inch,	5 "	5.55
B153,	$\frac{5}{16}$ inch,	3 "	3.40	B166,	"	6 "	6.25
B154,	"	4 "	3.65	B167,	"	7 "	7.00
B155,	"	5 "	4.10	B168,	"	8 "	7.75

FOR BOTTOM HUNG TRANSOMS.

B243,	$\frac{1}{4}$ inch,	3 feet,	\$2.90	B256,	$\frac{1}{2}$ inch,	6 feet,	5.30
B244,	"	4 "	3.25	B265,	$\frac{3}{8}$ inch,	5 "	6.00
B253,	$\frac{5}{16}$ inch,	3 "	3.65	B266,	"	6 "	6.75
B254,	"	4 "	4.10	B267,	"	7 "	7.50
B255,	"	5 "	4.60	B268,	"	8 "	8.25
Additional Rod,	$\frac{1}{4}$ inch,					per foot,	.35
"	"	$\frac{1}{2}$ "				"	.60
"	"	$\frac{3}{8}$ "				"	.65

\* Also furnished in Coppered Steel and Plated Finishes on Steel, Unpolished. For article on "Metals and Finishes" see page 595, and for Nomenclature of Finishes and Explanation of Finish Symbols see page 609.

† List numbers here given are for Bronze Lifters. Brass Lifters may be ordered by substituting letter A (Brass) for B (Bronze), as A143, etc. Prices of Bronze and Brass Lifters are the same.

See Note as to Method of Pricing, page 33. Cuts  $\frac{1}{4}$  Size.





1067



1068



1069



1073



1081



1074



1072

## Rim Turnbuckles.

Buffed Bronze or Brass.\*

No.			Each.
1068,	Plate,	$1\frac{5}{8} \times 1\frac{1}{8}$ inches,	\$1.10
1068 $\frac{1}{2}$ ,	"	$1\frac{5}{8} \times 1\frac{1}{8}$ " (with offset strike),	1.10
1067,	"	$1\frac{5}{8} \times 1\frac{1}{2}$ "	1.10
1067 $\frac{1}{2}$ ,	"	$1\frac{5}{8} \times 1\frac{1}{2}$ " (with offset strike),	1.10
1069,	"	$1\frac{5}{8} \times 1\frac{1}{2}$ "	1.10
1069 $\frac{1}{2}$ ,	"	$1\frac{5}{8} \times 1\frac{1}{2}$ " (with offset strike),	1.10
1073,	"	$1\frac{5}{8} \times \frac{5}{8}$ "	1.10
1073,	"	$1\frac{5}{8} \times 1\frac{1}{2}$ "	1.10
1081,	"	$1\frac{3}{4} \times 1\frac{3}{8}$ "	1.10
1072,†	"	$2\frac{3}{8} \times \frac{5}{8}$ "	1.00
1072,†	"	$2\frac{5}{8} \times \frac{5}{8}$ "	1.00
1074,	Case,	$3\frac{1}{4} \times 1\frac{1}{2}$ "	4.00

\* No. 1069 also made in Iron. For article on "Metals and Finishes" see page 595, and for Nomenclature of Finishes and Explanation of Finish Symbols see page 609.

† Adapted for use on swinging sashes, cupboards, etc.

See Note as to Method of Pricing, page 33. Cuts  $\frac{1}{4}$  Size.



1080

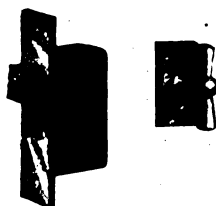

1079



1179



1078



1178

## Mortise Turnbuckles.

Buffed Bronze or Brass.\*

No.	Case,	with	No.	T-handle,	Each.
1080,	Case, $1\frac{3}{8} \times 1\frac{7}{8}$ inches,	with	No. 7	T-handle,	\$2.35
"	" $1\frac{1}{2} \times 1$	"	"	"	2.35
1079,	" $2\frac{1}{4} \times 1\frac{1}{8}$	"	"	9	1.90
"	" $2\frac{1}{4} \times 1\frac{1}{4}$	"	"	"	1.90
"	" $2\frac{1}{4} \times 1\frac{1}{2}$	"	"	"	2.10
"	" $2\frac{5}{8} \times 1\frac{7}{8}$	"	"	"	2.10
1078,	" $3\frac{1}{4} \times 2\frac{1}{8}$	"	"	10	2.75
"	" $3\frac{1}{2} \times 2\frac{5}{8}$	"	"	"	3.10

## WITH DEAD-LOCKING DEVICE.

1179,	Case, $2\frac{1}{4} \times 1\frac{1}{2}$ inches,	with	No. 9	T-handle,	2.60
1179R,	Rabbeted Front,				4.10
1178,	Case, $3\frac{1}{4} \times 2\frac{1}{8}$ inches,	with	No. 10	T-handle,	3.50
1178R,	Rabbeted Front,				5.25

\*No. 1078 has Japanned Iron case, all others have Bronze case. For article on "Metals and Finishes" see page 595, and for Nomenclature of Finishes and Explanation of Finish Symbols see page 609.

See Note as to Method of Pricing, page 33. Cuts  $\frac{1}{4}$  Size.

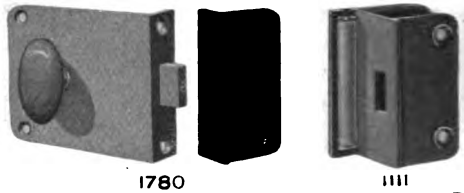

Flush Rim Knob Bolt.

Buffed Bronze or Brass.\*

No.	Each.
1780, Case, 3 × 3½ inches, and regular strike,	\$5.75
1780, with special strike for marble (No. 1111),	9.40

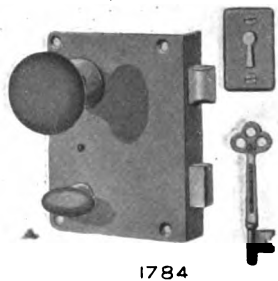

Flush Rim Knob Lock.

Buffed Bronze or Brass.\*

OPERATED.—Style A, Latch Bolt by Knob from inside, by Key from outside; Dead Bolt by Thumb-piece from inside; Style B, Latch Bolt by Knob from either side; Dead Bolt by Thumb-piece from inside only.

No.	Each
1784, Style A, Case, 4¾ × 3¾ inches.	\$10.50
1784, Style B, “ “ “	11.25

\* For article on "Metals and Finishes" see page 595, and for Nomenclature of Finishes and Explanation of Finish Symbols see page 609.

See Note as to Method of Pricing, page 33. Cuts ¼ Size.

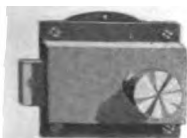

1086



1087

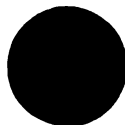

Indicator Bolts.

Buffed Bronze or Brass.\*

Operated from within by Knob, and Dial on outside displays "engaged" when Bolt is shot, and "open" when Bolt is withdrawn.

No.	Each.
1086, Rim Case, $2\frac{1}{2} \times 2\frac{3}{4}$ inches, . . . . .	\$4.25
1087, Mortise Case, $1\frac{5}{8} \times 2\frac{3}{4}$ inches, . . . . .	4.25



269



265

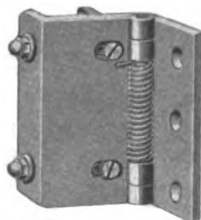

279

Butts and Clamp Hinges.

Buffed Bronze or Brass.\*

No.	Pair.
265, Fast Joint Surface Butts, $1\frac{7}{8} \times 4\frac{1}{2}$ inches, for wood, . . . . .	\$2.65
" " " " " " " " " " marble, . . . . .	6.00
269, Clamp Hinge, size of Butts, $3\frac{1}{2} \times 1\frac{3}{8}$ inches, for different thicknesses of marble as specified, . . . . .	11.00
279, Combined Clamp Hinge and Spring, size of Butt, $4 \times 3\frac{3}{4}$ inches. Adjustable to marble from $\frac{7}{8}$ to $1\frac{1}{4}$ inches thick, . . . . .	12.25

\* For article on "Metals and Finishes" see page 595, and for Nomenclature of Finishes and Explanation of Finish Symbols see page 609.

See Note as to Method of Pricing, page 33. Cuts  $\frac{1}{4}$  Size.

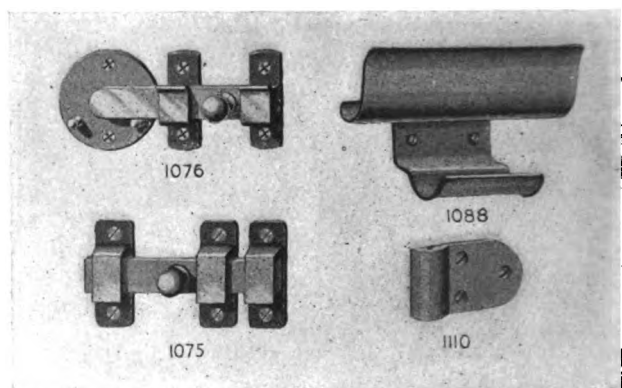

### Bolts, Latches, Hooks and Door Stops.

No.	BAR SLIDE BOLTS.	Each.*
1075,	2 1/4 x 4 1/2 inches, for wood, . . . . .	\$2.10
"	" " " " marble, . . . . .	5.40

#### CLOSET LATCHES.

1076,	2 x 4 5/8 inches, for wood, . . . . .	2.10
"	" " " " marble, . . . . .	5.40

#### COAT AND HAT HOOKS.

For list and illustrations see pages 794 and 795; No. 1603 is extensively specified for water closet use.

#### DOOR PULLS.

43,	5 1/2 x 1 1/2 inches (illustrated on page 846), . . . . .	1.00
-----	---	------

#### COMBINED CIGAR AND NEWSPAPER HOLDER.

1088,	3 x 4 1/2 inches, . . . . .	3.25
-------	-----------------------------	------

#### DOOR STOPS.

1110,	1 1/2 x 2 3/8 inches, with wood screws, . . . . .	1.20
"	" " " " expansion bolts, . . . . .	2.65
1111,	Height 3 inches, with bolts and nuts (see illustration page 790), made for various thicknesses of marble as specified, . . . . .	3.75

\* In Buffed Bronze or Brass. For article on "Metals and Finishes" see page 595, and for Nomenclature of Finishes and Explanation of Finish Symbols see page 609.

See Note as to Method of Pricing, page 33. Cuts 1/4 Size.

## Part VII.



### Hardware Groups.

## Part VII.

### Hardware Groups.\*

Section.	Page.
1. Door Pulls, . . . . .	823-846
2. Hinge and Corner Plates, . . . . .	847-866
3. Combined Escutcheon and Hinge Plates, . . . . .	868-869
4. Kick Plates, . . . . .	870-871
5. Combined Escutcheon and Kick Plates, . . . . .	872
6. Door Knockers, . . . . .	873-875
7. Combined Cylinder Plates and Ring Pulls, . . . . .	876
8. Nails and Studs, . . . . .	877
9. Lever Handles, . . . . .	878-879
10. Figures, . . . . .	880-884
11. Letters, . . . . .	885-886
12. Bolts: Cremorne, Espagnolette and Extension, . . . . .	887-894
13. Push Buttons, . . . . .	895-903
14. Cup Escutcheons, . . . . .	904-915
15. Flush Sash Lifts, . . . . .	916
16. Letter Drops and Hoods, . . . . .	917
17. Butts and Butt Tips, . . . . .	918-919
18. Switch Plates, . . . . .	920
19. Coat and Hat Hooks, . . . . .	921
20. Shutter Trim, . . . . .	922
21. Push Plates, . . . . .	923
22. Cylinders and Rings, . . . . .	924
23. Drawer Pulls, . . . . .	925-939
24. Metal Knobs for Drawers and Shutters, . . . . .	940-943
25. Glass Knobs for Doors, Drawers and Shutters, . . . . .	944-951
26. Key Plates, . . . . .	952

\* See illustrations following articles on Schools of Ornament, Part III, Section 3, pages 289 to 594. Also alphabetical list of Designs, pages 244 to 252.

# Section 1.

## Door Pulls.

Ornamental Door Pulls illustrated on pages 830 to 843, and priced on pages 823 to 829.

Plain Door Pulls illustrated on pages 844 to 846, and priced on pages 827 and 828.

For information as to other pieces in these designs see alphabetical list of all Designs, page 244.

For Designs arranged by Schools see page 236.

For article on "Metals and Finishes" see page 595, and for Nomenclature of Finishes and Explanation of Finish Symbols see page 609.

Design.	No.	Size in ins.	Page.	Finish.	Each.
Adams, . . . .	43 . .	16 <sup>1</sup> / <sub>2</sub> × 3 <sup>1</sup> / <sub>2</sub>	830 .	BZ10 .	\$28.00
Adria, . . . .	147 . .	23 <sup>5</sup> / <sub>8</sub> × 5 <sup>1</sup> / <sub>8</sub>	" .	CX22 .	38 25
Aix, . . . . .	47 Rt. .	9 × 2 <sup>5</sup> / <sub>8</sub>	" .	" .	7.25
Aix, . . . . .	47 Lt. .	" "	" .	" .	7.25
Alencon, . . . .	47 . .	12 <sup>1</sup> / <sub>4</sub> × 2 <sup>1</sup> / <sub>2</sub>	" .	" .	9.25
Amboise, . . . .	47 . .	12 × 2 <sup>1</sup> / <sub>2</sub>	" .	" .	11.75
Amherst, . . . .	43 . .	13 × 3 <sup>1</sup> / <sub>4</sub>	" .	BZ10 .	14.50
Arcadian, . . .	WA 322 . .	10 × 2 <sup>1</sup> / <sub>4</sub>	" .	CX22 .	4.50
Arcadian, . . .	SA 322 . .	" "	" .	SCX22 .	2.25
Arcola, . . . .	43 . .	6 <sup>5</sup> / <sub>8</sub> × 1 <sup>1</sup> / <sub>2</sub>	842 .	CY22 .	2.25
Argonne, . . . .	49 . .	12 <sup>1</sup> / <sub>2</sub> × 2 <sup>9</sup> / <sub>16</sub>	830 .	CX22 .	26.50
Argos, . . . . .	43 . .	10 <sup>7</sup> / <sub>8</sub> × 3	" .	AZ15 .	10.00
Arlington, . . .	47 . .	9 × 3	831 .	AZ10 .	7.75
Aurillac, . . . .	49 . .	15 × 2 <sup>3</sup> / <sub>4</sub>	" .	CX22 .	33.00
Austerlitz, . . .	47 . .	13 <sup>1</sup> / <sub>2</sub> × 2 <sup>1</sup> / <sub>2</sub>	" .	AZ15 .	9.25
Auvergne, . . .	43 . .	13 <sup>1</sup> / <sub>8</sub> × 3 <sup>3</sup> / <sub>8</sub>	" .	CX22 .	11.50
Auvergne, . . .	47 . .	" "	* .	" .	13.00

\*Not illustrated.



Design.	No.	Size in ins	Page.	Finish.	Each.
Auvergne, . . .	49 . . .	10 $\frac{3}{4}$ X 2 $\frac{1}{4}$	831 .	CX22 .	\$ 8.00
Beauvais, . . .	43 . . .	12 X 2 $\frac{3}{4}$	* .	AZ10 .	10.75
Beauvais, . . .	47 . . .	15 $\frac{7}{8}$ X 3 $\frac{3}{4}$	* .	" .	14.75
Beauvais, . . .	47 . . .	18 $\frac{1}{8}$ X 4 $\frac{1}{2}$	831 .	" .	19.50
Belfort, . . .	47 . . .	12 X 3	" .	CX22 .	8.50
Bergamo, . . .	47 . . .	15 $\frac{3}{8}$ X 3 $\frac{5}{8}$	" .	" .	14.50
Bergerac, . . .	49 . . .	12 $\frac{3}{8}$ X 2 $\frac{1}{4}$	" .	" .	8.00
Biarritz, . . .	47 . . .	13 X 2 $\frac{1}{2}$	" .	" .	13.75
Bonn, . . .	47 . . .	11 $\frac{1}{2}$ X 3	832 .	AX10 .	13.50
Bordeaux, . . .	43 . . .	17 $\frac{3}{4}$ X 2 $\frac{7}{8}$	" .	AZ10 .	20.00
Bothnian, . . .	WB322 . . .	10 X 2 $\frac{3}{4}$	" .	AY22 .	4.50
Bristol, . . .	43 . . .	11 X 3	" .	AZ10 .	6.75
Brabant, . . .	147 . . .	16 X 3 $\frac{3}{4}$	" .	CX22 .	21.00
Brunswick, . . .	43 . . .	15 $\frac{7}{8}$ X 3 $\frac{3}{4}$	" .	BZ10 .	16.00
Cambria, . . .	43 . . .	17 $\frac{1}{8}$ X 3 $\frac{1}{8}$	" .	CY22 .	16.00
Canterbury, . . .	147 . . .	28 X 3 $\frac{3}{4}$	" .	CX22 .	25.25
Castilian, . . .	SC322 . . .	10 X 2 $\frac{3}{4}$	" .	SCX17 .	2.25
Catania, . . .	147 . . .	28 $\frac{1}{4}$ X 4 $\frac{5}{8}$	" .	CX22 .	26.00
Cava, . . .	147 . . .	24 X 4 $\frac{3}{8}$	833 .	" .	33.75
Chantilly, . . .	47 . . .	13 X 2 $\frac{1}{2}$	" .	" .	13.75
Cluny, . . .	45 . . .	12 $\frac{3}{4}$ X 3 $\frac{3}{8}$	" .	" .	6.50
Cluny, . . .	47 . . .	" "	* .	" .	8.25
Chester, . . .	43 . . .	11 X 3	833 .	BZ10 .	6.75
Coburg, . . .	47 . . .	17 $\frac{1}{4}$ X 4 $\frac{3}{8}$	" .	AY22 .	17.00
Compiègne, . . .	47 . . .	13 X 2 $\frac{3}{4}$	" .	" .	17.00
Colonna, . . .	47 . . .	11 X 3 $\frac{1}{2}$	" .	BZ10 .	7.50
Colonna, . . .	49 . . .	7 $\frac{1}{2}$ X 2	" .	" .	7.75
Corinth, . . .	43 . . .	9 X 3 $\frac{1}{4}$	" .	AY22 .	10.50
Dodona, . . .	43 . . .	6 $\frac{5}{8}$ X 1 $\frac{1}{2}$	834 .	CX22 .	2.75
Dodona, . . .	45 . . .	12 X 2 $\frac{3}{4}$	* .	" .	8.75

\*Not illustrated.

Design.	No.	Size in ins.	Page.	Finish.	Each.
Dodona, . . .	47 . . .	19 X 4	833 .	CX22 .	\$19.00
Dodona, . . .	247 . . .	12 X 2¼	* .	" .	8.75
Dolphin, . . .	47R . . .	8½ X 2¼	834 .	" .	5.25
Dolphin, . . .	47L . . .	" "	" .	" .	5.25
Dorchester, . . .	47 . . .	10½ X 2½	" .	AZ15 .	8.25
Dorian, . . .	WD322 . . .	10 X 2¾	" .	AY22 .	4.50
Dorian, . . .	47 . . .	18 X 3½	* .	" .	16.75
Dorian, . . .	148 . . .	" "	* .	" .	20.50
Dormans, . . .	43 . . .	11 X 3	834 .	AY10 .	9.00
Douvaine, . . .	43 . . .	21¼ X 3¾	" .	CX22 .	41.00
Dresden, . . .	43 . . .	20¼ X 3½	" .	" .	19.00
Dreux, . . .	47 . . .	12 X 2½	" .	CY22 .	9.25
Ephesus, . . .	43 . . .	12½ X 3½	" .	CX22 .	13.50
Fairfax, . . .	43 . . .	13½ X 3¼	835 .	AZ10 .	13.50
Ferrara, . . .	47 . . .	13½ X 4	" .	CY22 .	19.25
Firenze, . . .	147 . . .	21 X 3¾	842 .	" .	16.25
Fleury, . . .	47 . . .	12 X 2¾	835 .	CX22 .	8.25
Fleury, . . .	47 . . .	18 X 2½	" .	" .	12.75
Florensac, . . .	43 . . .	16¼ X 3¾	" .	" .	19.50
Florian, . . .	222 . . .	7½ X 1¼	" .	BZ36 .	1.25
Florian, . . .	322 . . .	10 X 3	" .	" .	4.50
Florian, . . .	FF222 . . .	7½ X 1¼	" .	FBZ36 .	.40
Florian, . . .	FF322 . . .	10 X 3	" .	" .	1.75
Fontenoy, . . .	47 . . .	15 X 4½	" .	AZ15 .	22.00
Gardo, . . .	43 . . .	12¼ X 2¼	" .	CX22 .	6.50
Genoa, . . .	43 . . .	16 X 3¾	" .	BZ10 .	11.50
Gordian, . . .	43 . . .	12½ X 3½	836 .	CX17 .	6.75
Grenoble, . . .	47 . . .	11½ X 2½	" .	CX22 .	8.00
Guilford, . . .	47 . . .	10¾ X 3	" .	AZ10 .	6.50
Heidelberg, . . .	43 . . .	15 X 3½	" .	CY22 .	13.75

\* Not illustrated.

Design.	No.	Size in ins.	Page.	Finish.	Each.
Hellenian, . . .	43 . . .	13 <sup>3</sup> / <sub>4</sub> × 3 <sup>1</sup> / <sub>4</sub>	" . . .	AZ10 . . .	\$ 9.00
Hellenian, . . .	WH47 . . .	10 <sup>1</sup> / <sub>2</sub> × 3	842 . . .	" . . .	4.25
Hingham, . . .	45 . . .	10 <sup>1</sup> / <sub>4</sub> × 2 <sup>1</sup> / <sub>2</sub>	836 . . .	BZ10 . . .	9.00
Hingham, . . .	47 . . .	14 × 3 <sup>1</sup> / <sub>4</sub>	" . . .	" . . .	11.50
Hingham, . . .	49 . . .	9 <sup>1</sup> / <sub>2</sub> × 2	" . . .	" . . .	6.50
Hingham, . . .	147 . . .	16 <sup>3</sup> / <sub>8</sub> × 3 <sup>1</sup> / <sub>2</sub>	" . . .	" . . .	17.25
Hondo, . . .	47 . . .	12 <sup>1</sup> / <sub>2</sub> × 2 <sup>5</sup> / <sub>8</sub>	" . . .	CX22 . . .	7.50
Ionian, . . .	W147 . . .	10 <sup>1</sup> / <sub>2</sub> × 3	842 . . .	AZ10 . . .	4.25
Jamestown, . . .	47 . . .	11 <sup>1</sup> / <sub>4</sub> × 2 <sup>3</sup> / <sub>4</sub>	836 . . .	" . . .	12.50
Jena, . . .	47 . . .	13 <sup>1</sup> / <sub>2</sub> × 4	842 . . .	CX22 . . .	16.00
Jennico, . . .	FJ47 . . .	10 × 3	843 . . .	FCZ17 . . .	1.50
Kelp, . . .	43 . . .	7 <sup>1</sup> / <sub>2</sub> × 2	837 . . .	CX22 . . .	9.50
Kelp, . . .	47 . . .	15 <sup>1</sup> / <sub>4</sub> × 3 <sup>3</sup> / <sub>4</sub>	" . . .	" . . .	12.25
Largo, . . .	47 . . .	13 × 3	843 . . .	" . . .	8.50
Lariss, . . .	47 . . .	13 <sup>3</sup> / <sub>4</sub> × 3 <sup>3</sup> / <sub>4</sub>	837 . . .	BZ10 . . .	10.25
Libourne, . . .	147 . . .	20 <sup>5</sup> / <sub>8</sub> × 3 <sup>3</sup> / <sub>4</sub>	" . . .	CX22 . . .	30.50
Lodi, . . .	47 . . .	14 × 3 <sup>1</sup> / <sub>2</sub>	" . . .	CY22 . . .	14.25
Lodi, . . .	147 . . .	20 <sup>1</sup> / <sub>2</sub> × 3 <sup>5</sup> / <sub>8</sub>	" . . .	" . . .	16.25
Lynn, . . .	47 . . .	13 <sup>1</sup> / <sub>2</sub> × 2 <sup>1</sup> / <sub>2</sub>	" . . .	BZ10 . . .	8.25
Lyons, . . .	43 . . .	14 × 3 <sup>3</sup> / <sub>8</sub>	" . . .	CX22 . . .	14.00
Madras, . . .	322 . . .	10 <sup>5</sup> / <sub>8</sub> × 2 <sup>5</sup> / <sub>8</sub>	" . . .	FBZ3 . . .	4.50
Manchester, . . .	43 . . .	15 × 3 <sup>1</sup> / <sub>8</sub>	" . . .	CY22 . . .	13.25
Marathon, . . .	47 . . .	12 × 3	843 . . .	CZ17 . . .	7.75
Marathon, . . .	49 . . .	8 <sup>1</sup> / <sub>4</sub> × 2 <sup>1</sup> / <sub>4</sub>	* . . .	" . . .	5.00
Marathon, . . .	147 . . .	15 × 3	* . . .	" . . .	11.75
Marengo, . . .	47 . . .	13 <sup>1</sup> / <sub>2</sub> × 2 <sup>1</sup> / <sub>2</sub>	838 . . .	AZ15 . . .	9.25
Marly, . . .	47 . . .	19 <sup>7</sup> / <sub>8</sub> × 3 <sup>1</sup> / <sub>8</sub>	" . . .	CX22 . . .	13.25
Meaux, . . .	43 . . .	13 <sup>3</sup> / <sub>8</sub> × 3 <sup>1</sup> / <sub>8</sub>	" . . .	AZ15 . . .	20.75
Medford, . . .	47 . . .	11 × 3	" . . .	AZ10 . . .	8.00
Medici, . . .	47 . . .	14 × 3 <sup>1</sup> / <sub>2</sub>	" . . .	SX52 . . .	16.75

\*Not illustrated.

Design.	No.	Size in ins.	Page.	Finish.	Each
Medici, . . . .	147 . . .	20 <sup>5</sup> / <sub>8</sub> × 3 <sup>3</sup> / <sub>8</sub>	838 .	SX52 .	\$25.25
Menin, . . . .	43 . . . .	13 × 3 <sup>1</sup> / <sub>4</sub>	" .	AZ15 .	20.00
Mentz, . . . .	9 . . . . .	10 <sup>3</sup> / <sub>8</sub> × 2 <sup>1</sup> / <sub>2</sub>	" .	CX22 .	11.00
Mentz, . . . .	47 . . . .	14 × 3 <sup>1</sup> / <sub>4</sub>	" .	" .	6.00
Middlesex, . . .	47 . . . .	12 × 3 <sup>3</sup> / <sub>8</sub>	843 .	BZ10 .	14.50
Milan, . . . . .	43 . . . .	17 × 2 <sup>1</sup> / <sub>4</sub>	838 .	CY22 .	12.50
Miletus, . . . .	147 . . . .	17 <sup>1</sup> / <sub>4</sub> × 3 <sup>1</sup> / <sub>8</sub>	839 .	CX22 .	19.00
Milo, . . . . .	43 . . . .	21 <sup>1</sup> / <sub>2</sub> × 3 <sup>5</sup> / <sub>8</sub>	" .	" .	19.75
Monaco, . . . .	FM43 . . .	12 <sup>1</sup> / <sub>2</sub> × 2 <sup>1</sup> / <sub>4</sub>	843 .	FAZ17 .	1.25
Narbonne, . . .	43 . . . .	21 × 3 <sup>1</sup> / <sub>4</sub>	839 .	SX52 .	50.50
Navarro, . . . .	47 . . . .	13 <sup>1</sup> / <sub>2</sub> × 2 <sup>7</sup> / <sub>8</sub>	843 .	BX12 .	6.75
Nevers, . . . . .	47 . . . .	11 <sup>1</sup> / <sub>8</sub> × 3 <sup>1</sup> / <sub>8</sub>	839 .	BX67 .	13.75
Nimes, . . . . .	47 . . . .	11 × 3 <sup>1</sup> / <sub>2</sub>	" .	AZ10 .	15.25
Nimes, . . . . .	147 . . . .	16 <sup>1</sup> / <sub>4</sub> × 3 <sup>1</sup> / <sub>2</sub>	" .	" .	18.25
Oporto, . . . . .	43 . . . .	13 × 3	* .	AZ17 .	8.50
Palermo, . . . .	47 . . . .	15 × 3 <sup>1</sup> / <sub>2</sub>	839 .	SX52 .	21.25
Parma, . . . . .	147 . . . .	20 × 3 <sup>1</sup> / <sub>2</sub>	" .	CY22 .	21.50
Pasco, . . . . .	FP43 . . .	12 × 2 <sup>5</sup> / <sub>8</sub>	* .	FAX17 .	1.25
Piedmont, . . .	43 . . . .	11 <sup>1</sup> / <sub>2</sub> × 3	* .	AZ10 .	9.75
Piedmont, . . .	147 . . . .	24 × 5	* .	" .	18.75
Plain, . . . . .	40 . . . .	6 × 1 <sup>1</sup> / <sub>4</sub>	845 .	BZ10 .	1.60
" . . . . .	41 . . . .	10 × 3	" .	" .	5.75
" . . . . .	42 . . . .	11 × 2 <sup>5</sup> / <sub>8</sub>	844 .	" .	6.75
" . . . . .	42 <sup>1</sup> / <sub>2</sub> . . . .	" " .	" .	" .	6.75
" . . . . .	43 . . . .	5 <sup>1</sup> / <sub>2</sub> × 1 <sup>1</sup> / <sub>2</sub>	846 .	" .	1.00
" . . . . .	45 . . . .	11 × 3	844 .	" .	6.00
" . . . . .	45S . . . .	" " .	" .	" .	8.00
" . . . . .	46 . . . .	9 × 2 <sup>1</sup> / <sub>2</sub>	845 .	" .	4.50
" . . . . .	47 . . . .	11 × 3	844 .	" .	8.00
" . . . . .	47F . . . .	" " .	" .	" .	8.00

\*Not illustrated.

Design.	No.	Size in ins.	Page.	Finish.	Each
Plain, . . .	48 . . .	$7\frac{1}{2} \times 2\frac{3}{8}$	845 .	BZ10 .	\$ 4.25
" . . .	49 . . .	$7\frac{1}{2} \times 1\frac{1}{2}$	" .	" .	4.25
" . . .	146F . . .	$14 \times 3\frac{1}{4}$	846 .	" .	10.75
" . . .	147 . . .	" "	" .	" .	11.00
" . . .	148 . . .	$20\frac{1}{4} \times 4$	" .	" .	14.25
" . . .	225 . . .	$4\frac{7}{8} \times \frac{7}{8}$	" .	" .	.60
" . . .	247 . . .	$10 \times 2\frac{1}{2}$	845 .	" .	4.60
" . . .	W322 . . .	$10 \times 2\frac{1}{4}$	" .	" .	2.40
" . . .	S322 . . .	" "	" .	" .	1.40
" . . .	324 . . .	$10\frac{5}{8} \times 2\frac{5}{8}$	844 .	" .	5.00
" . . .	347 . . .	$11 \times 2\frac{5}{8}$	" .	" .	4.85
" . . .	442 . . .	$4\frac{1}{2} \times \frac{3}{4}$	845 .	" .	.40
" . . .	1367 . . .	$3\frac{1}{4} \times \frac{1}{2}$	" .	" .	.35
" . . .	1368 . . .	$4\frac{1}{2} \times \frac{5}{8}$	" .	" .	.45
" . . .	1369 . . .	$5\frac{3}{8} \times 1\frac{1}{4}$	" .	" .	.80
" . . .	1740 . . .	$11 \times 3$	" .	" .	7.00
" . . .	1741 . . .	$14 \times 3\frac{1}{4}$	" .	" .	8.00
Plymouth, . . .	43 . . .	$8\frac{1}{4} \times 1\frac{1}{2}$	* .	AZ10 .	5.50
Plymouth, . . .	47 . . .	$14 \times 3\frac{3}{4}$	839 .	" .	10.75
Realmont, . . .	45 . . .	$11\frac{3}{4} \times 3\frac{1}{2}$	* .	CX22 .	7.75
Realmont, . . .	47 . . .	$15\frac{1}{2} \times 3\frac{1}{2}$	839 .	" .	10.50
Rialto, . . .	47 . . .	$12\frac{1}{4} \times 2\frac{7}{8}$	840 .	AX61 .	18.00
Rivoli, . . .	147 . . .	$30\frac{1}{8} \times 4\frac{1}{2}$	" .	CX22 .	35.00
Roanoke, . . .	47 . . .	$11 \times 3\frac{1}{2}$	* .	AZ10 .	12.50
Roanoke, . . .	147 . . .	$14 \times 3\frac{3}{4}$	840 .	" .	15.25
Saarbruck, . . .	43 . . .	$16 \times 3\frac{3}{8}$	" .	CX22 .	13.75
Salem, . . .	47 . . .	$14 \times 3\frac{3}{4}$	" .	AZ10 .	11.00
Senlis, . . .	47 . . .	$13\frac{1}{4} \times 3\frac{5}{8}$	" .	CX22 .	14.50
Sevres, . . .	47 . . .	$16\frac{5}{8} \times 4\frac{3}{8}$	" .	" .	16.25
Siena, . . .	47 . . .	$12 \times 2\frac{5}{8}$	" .	" .	9.75

\*Not illustrated.

Design.	No.	Size in ins.	Page	Finish.	Each.
Siena, . . .	147 . .	$18\frac{7}{8} \times 3\frac{3}{4}$	840 .	CX22 .	\$21.00
Sparta, . . .	47 . .	$10\frac{1}{4} \times 2\frac{7}{8}$	* .	BZ10 .	7.75
Sparta, . . .	47 . .	$14\frac{5}{8} \times 3\frac{1}{2}$	840 .	" .	10.50
St. Cloud, . . .	47 . .	$12\frac{1}{2} \times 2\frac{3}{4}$	841 .	AY22 .	13.25
Stonington, . . .	147 . .	20 X 4	* .	BZ10 .	17.25
Stratford, . . .	147 . .	15 X $4\frac{1}{4}$	841 .	CX22 .	21.25
Tosca, . . .	43 . .	$16\frac{1}{4} \times 3$	" .	CY22 .	15.75
Touraine, . . .	147 . .	16 X 4	" .	CX22 .	17.25
Treviso, . . .	47 . .	15 X 3	" .	CY22 .	21.25
Treviso, . . .	47 . .	$16\frac{3}{8} \times 3\frac{7}{8}$	" .	" .	24.25
Treviso, . . .	147 . .	$19\frac{1}{4} \times 3\frac{7}{8}$	" .	" .	25.25
Trianon, . . .	43 . .	$14\frac{1}{2} \times 2\frac{7}{8}$	" .	" .	14.50
Tunis, . . .	47 . .	$11\frac{1}{2} \times 2\frac{1}{4}$	" .	CX22 .	9.75
Urbino, . . .	43 . .	16 X $3\frac{1}{4}$	842 .	" .	12.50
Urbino, . . .	47 . .	" "	841 .	" .	11.50
Urbino, . . .	147 . .	$20\frac{3}{4} \times 3\frac{3}{8}$	842 .	" .	18.00
Vercelli, . . .	49 . .	19 X $3\frac{1}{4}$	" .	" .	79.25
Versailles, . . .	43 . .	$14\frac{1}{4} \times 2\frac{1}{4}$	" .	CY22 .	17.75
Yorktown, . . .	43 . .	$9\frac{1}{2} \times 2\frac{1}{2}$	843 .	AZ10 .	6.75

\*Not illustrated.



ADAMS



ADRIA



AIX



AIX



ALENCON



AMBOISE



AMHERST



ARCADIAN



ARGONNE



ARJOS

### Ornamental Door Pulls.

For prices see pages 823 to 829. Illustrations about 1/8 size.



ARLINGTON



AURILLAC



AUSTERLITZ



AUVERGNE



AUVERGNE



BEAUVAIS



BELFORT



BELFAMO



BELLEVILLE



BELLEVILLE

### Ornamental Door Pulls.

For prices see pages 823 to 829. Illustrations about 1/2 size.





BOVN



BOULEAUX



BOTHANIAN



BRITTON



BRABANT



BRUNSWICK



CAMBRIDGE



CANTON



CATANIA



CASTLEMAN

Ornamental Door Pulls.

For prices see pages 823 to 829. Illustrations about 1/8 size



CEVA



CHANTILLY



CHESTER



COBURG



CLUNY



COLONNA



COLONNA



COMPIEGNE



COPENHAGEN



DODONA

Ornamental Door Pulls.

For prices see pages 823 to 829. Illustrations about 1/8 size.



DODONA



DOLPHIN



DOLPHIN



DORCHESTER



DOHMANS



DOUVAINE



DRESDEN



DREUX



EPHEBUS

### Ornamental Door Pulls.

For prices see pages 823 to 829. Illustrations about  $\frac{1}{8}$  size.



FAIRFAX



FERRARA



FLEURY



FLEURY



FLORENSAC



FLORIAN



FLORIAN



FONTENDY



GARDO



GENOA

Ornamental Door Pulls.

For prices see pages 823 to 829. Illustrations about 1/8 size.



GORDIAN



SPENGLER



GUILFORD



HINGHAM



HINGHAM



HINGHAM



HINGHAM



HONDO



HEIDELBERG



JAMESTOWN

## Ornamental Door Pulls.

For prices see pages 823 to 829. Illustrations about 1/2 size.



KELP



KELP



LARISSA



LIBOURNE



LODI



LODI



LYNN



LYONS



MALIBAR



MANCHESTER

Ornamental Door Pulls.

For prices see pages 823 to 829. Illustrations about 1/8 size.



MAHENDO



MARLY



MEALY



MEDFORD

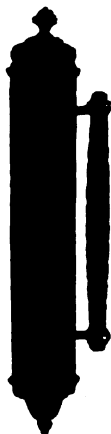

MEDIC



MEDICI



MENIN



MENTZ



MENTZ



MILAN

### Ornamental Door Pulls.

For prices see pages 823 to 829. Illustrations about  $\frac{1}{8}$  size.



MILU



MILETUS



NAPHEUNY



NEVERN



NIMES



NIMES



PALCHIM



PALMORUM



PALM



PALMORUM

Ornamental Door Pulls.

For prices see pages 823 to 829. Illustrations about 1/3 size.





814-TJ



80-ANOKE



814-TJ-USA



814-TJ



814-TJ



814-TJ



814-TJ



814-TJ

Ornamental Door Pulls.

For prices see pages 823 to 829. Illustrations about 1/8 size.



ST. CLOUD



STRATFORD



TONNA



TOURNAI

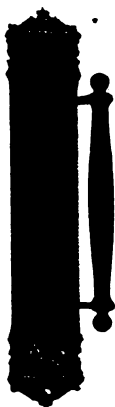

TREVISO



TREVISO



TREVISO



TRIANON



TUNIS



TUNIS

Ornamental Door Pulls.

For prices see pages 823 to 829. Illustrations about  $\frac{1}{8}$  size.

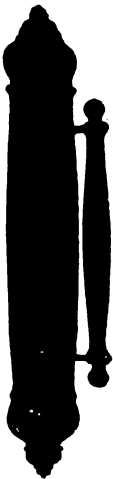

URBINO



URBINO



VERSAILLES



VERSAILLES



ARCOLA



HELLENIAN



FIRENZI



JENA



IONIAN

Ornamental Door Pulls.

For prices see pages 823 to 829. Illustrations about 1/8 size.



MIDDLESEX



LARGO



MARATHON



NAVARRO



JENNICO



YORKTOWN



MONACO

### Ornamental Door Pulls.

For prices see pages 823 to 829. Illustrations about 1/8 size.



42



42½



45



45 S

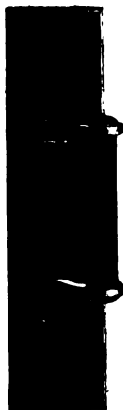

324



347



47



47 F

### Plain Door Pulls.

For prices see pages 827 and 828. Illustrations about one-fifth size.



46



247



41



1741



1740



W&S 322



48



49



40

Plain Door Pulls.

For prices see pages 827 and 828. Illustrations about one-fifth size.

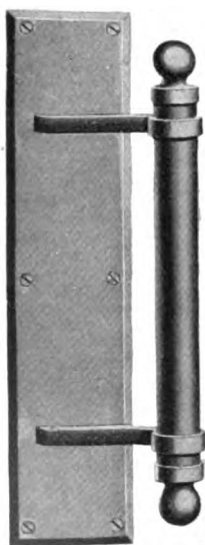

147



146 F

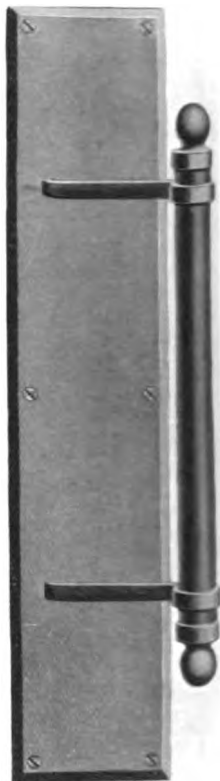

148



43'



225



442



1369



1368



1367

### Plain Door Pulls.

For prices see pages 827 and 828. Illustrations about one-fifth size.

## Section 2.

### Hinge and Corner Plates.

Suitable for Front, Inside or Cabinet Doors.

For article on "Metals and Finishes" see page 595, and for Nomenclature of Finishes and Explanation of Finish Symbols see page 609.

See note as to method of pricing, page 33.

**CLUE LETTERS:** T—Top Hinge Plate. TB—Top or Bottom Hinge Plate. C—Corner Plate. B—Bottom Hinge Plate. M—Middle Hinge Plate. S—Strap Hinge.

Design.	Letters.	Size in ins.	Page.	Fig.	Finish.	Each.
Adams,	TB	$16\frac{1}{2} \times 12\frac{1}{4} \times 3\frac{1}{2}$	*	*	FX80	\$ 54.75
"	M1	$16\frac{1}{2} \times 11\frac{1}{2} \times 4$	858	24	"	49.50
"	M2	$16\frac{1}{2} \times 4$	*	*	"	35.50
"	C	$9\frac{1}{4} \times 9\frac{1}{4} \times 3\frac{1}{2}$	*	*	"	43.00
Agen,	TB1	$25\frac{1}{4} \times 37\frac{7}{8} \times 7\frac{5}{8}$	856	1	"	59.75
"	TB2	$17\frac{1}{4} \times 37\frac{7}{8} \times 7\frac{5}{8}$	*	*	"	52.00
Amherst,	TB	$12 \times 12 \times 3\frac{1}{4}$	856	5	BZ10	24.25
Amiens,	TB	$15\frac{3}{4} \times 20\frac{1}{2}$	"	6	FX80	67.75
Archala,	M	$10 \times 29\frac{1}{2}$	860	42	CX22	25.50
Aspremont,	M1	$10\frac{3}{4} \times 20$	857	16	FX80	14.25
"	M2	$10\frac{3}{4} \times 31\frac{1}{2}$	*	*	"	23.75
Aubigny,	S	$20 \times 33\frac{1}{4}$	858	23	"	196.00
Aubin,	TB3†	$4\frac{3}{8} \times 3\frac{3}{8}$	973	7&8	AZ10	3.25
"	TB4†	$4\frac{1}{4} \times 3\frac{1}{2}$	"	9&10	"	3.50
"	TB5†	$4\frac{1}{4} \times 3\frac{3}{8}$	"	3&4	"	3.00
"	TB6†	$2\frac{7}{8} \times 3\frac{1}{2}$	"	5&6	"	3.25
Aumont,	TB†	$7\frac{5}{8} \times 5\frac{7}{8} \times 1\frac{5}{8}$	974	8	FX80	3.50
"	M1†	$9\frac{7}{8} \times 5\frac{7}{8} \times 1\frac{7}{8}$	"	5	"	3.50
"	M2†	$8\frac{1}{8} \times 2$	"	2	"	2.25

\* Not illustrated.

† Suitable for Cabinet Doors.



Design.	Letters.	Size in ins.	Page.	Fig.	Finish.	Each.
Auvergne,	TB1	$11\frac{1}{4} \times 8\frac{1}{4} \times 3\frac{3}{8}$	*	*	CX22	\$11.50
"	TB2	$19\frac{5}{8} \times 14 \times 3\frac{1}{2}$	*	*	"	24.50
"	TB3	$15 \times 10 \times 3\frac{1}{2}$	*	*	"	16.50
"	TB4	$17\frac{1}{2} \times 15\frac{1}{2} \times 4\frac{1}{2}$	856	8	"	23.50
"	M	$12\frac{1}{4} \times 3\frac{1}{2}$	*	*	"	10.25
"	C	$10 \times 10 \times 3\frac{1}{2}$	856	9	"	15.50
Bayonne,	S†	$4\frac{1}{4} \times 15\frac{1}{2}$	857	12	"	10.25
Beaucaire,	M	$16\frac{1}{4} \times 11\frac{3}{4}$	864	78	"	15.25
"	C1	$24\frac{1}{2} \times 17$	*	*	"	49.75
"	C2	$22 \times 16\frac{1}{4}$	864	80	"	29.25
Beauvais,	TB1	$23\frac{3}{4} \times 23\frac{3}{4} \times 4\frac{1}{2}$	858	30	AZ10	46.50
"	TB2	$18 \times 14\frac{5}{8} \times 4\frac{3}{8}$	"	27	"	30.00
"	M1	$28 \times 4\frac{3}{4}$	"	28	"	37.00
"	M2	$18 \times 4\frac{1}{2}$	*	*	"	22.25
Beauvoir,	M†	$5\frac{3}{4} \times 1\frac{3}{4}$	977	1&4	CX22	3.25
Bennington,	M	$5\frac{1}{4} \times 26\frac{1}{4}$	863	71	"	18.00
Bergamo,	TB	$17\frac{3}{8} \times 13\frac{3}{8} \times 3\frac{1}{2}$	"	70	"	31.25
Bernay,	M	$15\frac{3}{8} \times 21$	859	32	FX80	115.75
Beverly,	S1†	$4 \times 3\frac{1}{4}$	976	5	BZ10	3.50
"	S2†	$3\frac{1}{2} \times 3\frac{1}{2}$	"	2	"	3.50
"	M†	$4 \times 1\frac{5}{8}$	*	*	"	2.50
Bordeaux,	TB	$14\frac{3}{4} \times 18\frac{1}{4} \times 4\frac{1}{8}$	861	47	AZ10	26.25
"	M	$19\frac{3}{4} \times 5\frac{1}{8}$	857	18	"	26.00
Bourg,	TB1	$16\frac{1}{4} \times 16\frac{1}{2} \times 3\frac{3}{8}$	*	*	CX22	18.50
"	TB2	$15\frac{3}{4} \times 12\frac{1}{2} \times 4\frac{1}{4}$	*	*	"	18.00
"	TB3	$15\frac{1}{2} \times 11 \times 3\frac{3}{4}$	861	52	"	18.00
"	M1	$14 \times 11\frac{3}{4} \times 4\frac{3}{8}$	"	54	"	24.75
"	M2	$17\frac{7}{8} \times 4$	*	*	"	12.00
"	M3	$17 \times 3\frac{3}{4}$	*	*	"	12.75
"	M4	$6\frac{1}{8} \times 18\frac{1}{8}$	*	*	"	13.00

\* Not illustrated.

† Suitable for Cabinet Doors.

Design.	Letters.	Size in ins.	Page.	Plg.	Finish.	Each.
Bourg,	C	17 × 12 <sup>1</sup> / <sub>8</sub>	*	*	CX22	\$17.50
Brest,	TB	6 × 18	*	*	FX80	12.25
"	M	10 <sup>1</sup> / <sub>4</sub> × 31	864	79	"	20.75
Brioude,	M1	7 <sup>3</sup> / <sub>4</sub> × 34 <sup>1</sup> / <sub>4</sub>	857	10	CX22	20.25
"	M2	7 <sup>3</sup> / <sub>4</sub> × 28 <sup>1</sup> / <sub>4</sub>	"	14	"	17.50
"	M3	7 <sup>3</sup> / <sub>4</sub> × 25 <sup>1</sup> / <sub>4</sub>	*	*	"	16.50
Bristol,	C†	5 <sup>1</sup> / <sub>4</sub> × 5 <sup>1</sup> / <sub>4</sub> × 1 <sup>1</sup> / <sub>8</sub>	*	*	BZ10	2.50
Caen,	M1†	7 <sup>3</sup> / <sub>8</sub> × 3 <sup>3</sup> / <sub>4</sub>	*	*	CX22	3.75
"	M2†	7 <sup>1</sup> / <sub>4</sub> × 3 <sup>5</sup> / <sub>8</sub>	*	*	"	3.75
"	M3†	7 <sup>1</sup> / <sub>4</sub> × 3 <sup>1</sup> / <sub>2</sub>	*	*	"	3.75
"	M4†	6 <sup>1</sup> / <sub>8</sub> × 3	979	1	"	3.75
"	M5†	5 <sup>7</sup> / <sub>8</sub> × 5	*	*	"	3.75
"	M6†	5 <sup>5</sup> / <sub>8</sub> × 2 <sup>7</sup> / <sub>8</sub>	*	*	"	3.75
"	M7†	4 <sup>7</sup> / <sub>8</sub> × 2 <sup>3</sup> / <sub>8</sub>	*	*	"	3.75
"	C†	5 × 4 <sup>3</sup> / <sub>4</sub>	979	3	"	5.25
Chalons,	M1	18 <sup>1</sup> / <sub>8</sub> × 28 <sup>1</sup> / <sub>4</sub>	864	81	FX80	24.25
"	M2	17 <sup>7</sup> / <sub>8</sub> × 35 <sup>1</sup> / <sub>2</sub>	*	*	"	31.75
Cherbourg,	M	13 <sup>1</sup> / <sub>4</sub> × 26 <sup>5</sup> / <sub>8</sub>	859	34	"	21.75
Clermont,	TB1†	5 <sup>1</sup> / <sub>2</sub> × 4 × 1 <sup>3</sup> / <sub>4</sub>	979	1	CX22	4.75
"	TB2†	5 × 5 × 1 <sup>1</sup> / <sub>2</sub>	*	*	"	4.75
"	TB3†	4 <sup>3</sup> / <sub>4</sub> × 4 <sup>5</sup> / <sub>8</sub> × 1 <sup>1</sup> / <sub>2</sub>	*	*	"	4.75
"	M†	6 <sup>1</sup> / <sub>4</sub> × 1 <sup>3</sup> / <sub>4</sub>	979	4	"	3.25
Cluny,	TB1†	5 <sup>3</sup> / <sub>4</sub> × 5 <sup>3</sup> / <sub>4</sub> × 1 <sup>1</sup> / <sub>2</sub>	975	3&4	"	2.50
"	TB2†	9 <sup>1</sup> / <sub>4</sub> × 5 <sup>3</sup> / <sub>4</sub> × 1 <sup>1</sup> / <sub>2</sub>	862	60&61	"	5.00
"	TB3	15 × 12 × 3 <sup>1</sup> / <sub>2</sub>	*	*	"	14.50
"	TB4	18 × 14 <sup>3</sup> / <sub>4</sub> × 3 <sup>3</sup> / <sub>8</sub>	*	*	"	18.75
"	TB5	15 <sup>7</sup> / <sub>8</sub> × 12 <sup>1</sup> / <sub>2</sub> × 4 <sup>1</sup> / <sub>8</sub>	*	*	"	16.75
"	TB6	15 <sup>3</sup> / <sub>8</sub> × 15 <sup>3</sup> / <sub>8</sub> × 3 <sup>3</sup> / <sub>4</sub>	*	*	"	17.50
"	TB7†	7 <sup>1</sup> / <sub>8</sub> × 5 <sup>7</sup> / <sub>8</sub> × 1 <sup>1</sup> / <sub>2</sub>	862	57	"	2.75
"	M1†	9 × 1 <sup>1</sup> / <sub>2</sub>	975	5	"	4.75

\* Not illustrated.

† Suitable for Cabinet Doors.

Design.	Letters.	Size in ins.	Page.	Fig.	Finish.	Each.
Cluny,	M2	15 X 3½	*	*	CX22	\$11.25
"	M3	15¾ X 4½	*	*	"	12.75
Concord,	TB†	6½ X 4¼ X 1¼	977	3&4	AZ10	4.25
Cydonia,	S1†	2¼ X 12½	857	15	CX22	6.75
"	S2†	3 X 9¼	865	88	"	6.75
"	M†	2 X 17	857	19	"	5.00
Dax,	M†	3½ X 1¾	978	1&4	CX22	3.25
Dieppe,	M	9¾ X 27¾	856	4	FX80	12.25
Donjon,	TB	34 X 28 X 6	"	7	"	66.00
Dresden,	TB	19½ X 12½ X 4½	*	*	"	28.50
"	M1	23 X 14½ X 4¾	858	26	"	32.50
"	M2	22½ X 4½	*	*	"	26.00
"	C	12 X 12 X 4½	*	*	"	21.00
Duranno,	M1	8¾ X 23¼	*	*	"	11.00
"	M2	6 X 28¾	864	76	"	10.25
Durban,	T	20 X 26½ X 3½	*	*	"	13.50
"	B	13¾ X 27½ X 7½	865	91	"	19.50
"	M	20¼ X 24¾ X 5½	*	*	"	19.25
Duxbury,	M	8¾ X 41	856	3	CX22	88.50
Elne,	TB1†	10 X 5¾ X 1¾	980	1	"	4.75
"	TB2†	9¼ X 6¾ X 1¾	"	3	"	4.75
"	M†	7¾ X 1½	"	4	"	3.25
Epernay,	TB†	6½ X 1¾	978	1&4	"	5.25
Ferrara,	M1†	4½ X 1½	982	7	GZ10	26.50
"	M2†	10¾ X 3¾	"	8	"	60.50
"	M3†	2¾ X 1	*	*	"	26.50
Flavigny,	TB	20 X 32	865	90	FX80	44.00
Foix,	M1	14½ X 29¾	*	*	"	121.00
"	M2	"	862	58	"	139.50
Fontenoy,	M†	5 X 1½	*	*	GY10	26.50

\* Not illustrated.

† Suitable for Cabinet Doors.

Designs.	Letters.	Size in ins.	Page.	Fig.	Finish.	Each.
Gardo,	C†	$5\frac{1}{2} \times 5\frac{1}{2} \times 1\frac{3}{8}$	*	*	CX22	\$ 2.50
"	TB	$15 \times 18$	*	*	"	18.50
Gironde,	M1	$17 \times 27\frac{7}{8}$	860	43	FX80	20.00
"	M2	$17 \times 17\frac{1}{2}$	*	*	"	18.50
Granville,	M	$19\frac{1}{8} \times 6\frac{5}{8}$	859	31	CX22	12.75
Greenfield,	S†	$6\frac{1}{4} \times 14\frac{3}{8}$	866	92	BZ10	8.50
Gueret,	T	$20 \times 27\frac{1}{4} \times 4\frac{3}{8}$	*	*	FX80	39.00
"	M	$25 \times 5\frac{1}{8}$	*	*	"	25.00
"	B	$16\frac{1}{4} \times 29\frac{1}{4} \times 7\frac{1}{2}$	*	*	"	35.00
Hamburg,	M1†	$8\frac{7}{8} \times 5\frac{1}{8}$	*	*	FX80	2.25
"	M2†	$8\frac{7}{8} \times 4\frac{1}{8}$	861	53	FX80	2.25
Hingham,	TB1†	$7 \times 7 \times 1\frac{1}{2}$	984	1	AZ10	4.00
"	TB2	$12 \times 12 \times 3\frac{1}{2}$	857	20	"	16.00
"	M	$12\frac{3}{8} \times 6\frac{3}{4} \times 3\frac{1}{2}$	*	*	"	13.00
"	C1†	$7 \times 10 \times 1\frac{1}{2}$	984	10	"	5.00
"	C2†	$8\frac{1}{2} \times 8\frac{1}{2} \times 2\frac{1}{4}$	*	*	"	7.50
"	C3†	$6 \times 6 \times 2$	*	*	"	2.75
"	C4†	$5\frac{1}{2} \times 4 \times 1$	984	9	"	2.75
Hondo,	C†	$5\frac{1}{2} \times 5\frac{1}{2} \times 1\frac{3}{8}$	*	*	CX22	2.75
Ivry,	TB†	$6\frac{5}{8} \times 6\frac{1}{4} \times 1$	985	6	"	11.75
"	C1†	$16 \times 7\frac{1}{4} \times 1\frac{1}{4}$	"	8	"	19.00
"	C2†	$16 \times 4\frac{1}{2} \times 1\frac{1}{4}$	"	7	"	18.25
"	C3†	$6\frac{1}{8} \times 5\frac{1}{2} \times \frac{7}{8}$	"	1	"	11.50
Jarnac,	TB†	$3\frac{7}{8} \times 3 \times 1\frac{5}{8}$	980	1&3	"	4.75
"	M†	$3\frac{7}{8} \times 1\frac{5}{8}$	"	2	"	3.25
Jena,	TB	$18 \times 18 \times 4\frac{1}{2}$	860	46	SX52	51.50
Kelp,	TB1†	$5 \times 4 \times 1\frac{5}{8}$	983	12&13	FX80	3.00
"	TB2	$11\frac{3}{4} \times 9\frac{1}{4} \times 3\frac{3}{4}$	861	50	"	8.50
"	M1†	$5 \times 1\frac{1}{2}$	983	7&10	"	2.00
"	M2	$11\frac{3}{4} \times 3\frac{3}{4}$	*	*	"	6.50

\* Not illustrated.

† Suitable for Cabinet Doors.

Design.	Letters.	Size in ins.	Page.	Fig.	Finish.	Each.
Kelp	M3†	3 $\frac{3}{4}$ × 4 $\frac{1}{4}$	*	*	FX80	\$ 2.00
"	M4†	3 $\frac{1}{8}$ × 1 $\frac{1}{8}$	983	4	"	2.00
"	C1	13 $\frac{3}{4}$ × 9 $\frac{1}{4}$ × 3 $\frac{3}{4}$	*	*	"	11.25
"	C2	10 $\frac{1}{2}$ × 10 $\frac{1}{2}$ × 3 $\frac{1}{8}$	861	48	"	8.50
Lagrasse,	M†	6 $\frac{1}{8}$ × 1 $\frac{3}{4}$	981	144	CX22	3.25
Leicester,	TB	21 $\frac{5}{8}$ × 33 × 4 $\frac{3}{8}$	*	*	"	59.00
"	M1	25 $\frac{3}{4}$ × 33 $\frac{1}{4}$ × 4 $\frac{3}{8}$	859	33	"	56.00
"	M2	25 $\frac{1}{2}$ × 25 $\frac{1}{2}$ × 4 $\frac{3}{8}$	*	*	"	54.00
"	M3	22 $\frac{3}{4}$ × 4 $\frac{3}{8}$	*	*	"	25.00
Lexington,	TB†	10 $\frac{1}{2}$ × 8 × 2 $\frac{5}{8}$	985	5	AZ10	9.50
"	M†	5 $\frac{3}{4}$ × 2 $\frac{5}{8}$	*	*	"	3.50
Lyons,	TB†	5 $\frac{1}{8}$ × 5 $\frac{1}{8}$ × 1 $\frac{5}{8}$	*	*	CX22	4.75
"	M†	5 $\frac{1}{8}$ × 1 $\frac{5}{8}$	*	*	"	3.25
Manchester,	TB	17 × 18 × 4 $\frac{1}{8}$	863	66&67	CY22	29.00
"	M	18 × 4 $\frac{1}{8}$	"	68	"	19.00
Margaux,	TB1	7 $\frac{1}{2}$ × 20 × 3	*	*	CX22	21.00
"	TB2	12 × 32 $\frac{1}{2}$ × 4 $\frac{5}{8}$	864	74	"	37.50
"	M1	12 × 20 × 3	*	*	"	17.00
"	M2	20 × 32 $\frac{1}{2}$ × 4 $\frac{5}{8}$	*	*	"	37.50
"	M3	26 $\frac{5}{8}$ × 24 × 4	864	73	"	41.00
Marly,	TB	20 $\frac{1}{4}$ × 19 $\frac{7}{8}$ × 4	859	37	"	45.75
"	M1	20 × 4	*	*	"	30.50
"	M2	20 $\frac{1}{4}$ × 19 $\frac{3}{4}$ × 4	859	35	"	45.75
Melun,	M	13 × 24 $\frac{5}{8}$	860	38	FX80	24.50
Milan,	T1†	5 $\frac{3}{4}$ × 3 $\frac{3}{4}$ × 1 $\frac{1}{4}$	988	146	SY55	11.25
"	T2	18 $\frac{1}{2}$ × 13 $\frac{3}{4}$ × 4	*	*	"	47.25
"	B1†	5 $\frac{3}{4}$ × 3 $\frac{3}{8}$ × 1 $\frac{1}{4}$	860	45	"	11.25
"	B2	18 $\frac{1}{2}$ × 11 × 5 $\frac{7}{8}$	*	*	"	41.00
"	M2	17 $\frac{1}{2}$ × 3 $\frac{7}{8}$	*	*	"	32.25
"	M3†	6 $\frac{1}{2}$ × 1 $\frac{1}{8}$	988	3	"	7.50

\* Not illustrated.

† Suitable for Cabinet Doors.

Design.	Letters.	Size in ins.	Page.	Fig.	Finish.	Each.
Montauban,	M1†	4 <sup>1</sup> / <sub>8</sub> × 3 <sup>1</sup> / <sub>2</sub>	*	*	FX80	\$ 2.25
"	M2†	4 <sup>1</sup> / <sub>8</sub> × 1 <sup>1</sup> / <sub>2</sub>	981	1&4	"	2.25
Montins,	M	7 <sup>1</sup> / <sub>8</sub> × 39 <sup>1</sup> / <sub>4</sub>	860	39	CX22	34.00
Murat,	M†	5 <sup>1</sup> / <sub>2</sub> × 14 <sup>3</sup> / <sub>4</sub>	866	98	"	4.50
Nahant,	S	3 <sup>5</sup> / <sub>8</sub> × 11	"	99	BZ10	8.75
Nantes,	M1	17 <sup>1</sup> / <sub>16</sub> × 21 <sup>3</sup> / <sub>4</sub> × 8 <sup>5</sup> / <sub>8</sub>	*	*	CX22	21.00
"	M2	17 × 31 <sup>1</sup> / <sub>2</sub> × 5 <sup>5</sup> / <sub>8</sub>	858	22	"	23.00
"	M3	16 <sup>3</sup> / <sub>4</sub> × 31 <sup>3</sup> / <sub>4</sub> × 8 <sup>1</sup> / <sub>2</sub>	*	*	"	23.50
Narbonne,	TB	20 <sup>1</sup> / <sub>2</sub> × 30 <sup>7</sup> / <sub>8</sub> × 5 <sup>5</sup> / <sub>8</sub>	864	75	"	32.00
"	M	21 × 5 <sup>1</sup> / <sub>4</sub>	*	*	"	3.75
Novara,	TB	25 <sup>5</sup> / <sub>8</sub> × 23 <sup>1</sup> / <sub>4</sub>	862	64	FX80	79.50
"	M	20 <sup>1</sup> / <sub>8</sub> × 19 <sup>3</sup> / <sub>4</sub>	"	62	"	132.00
Pau,	M	7 × 34 <sup>5</sup> / <sub>8</sub>	859	36	CX22	45.50
Pesaro,	M	28 <sup>1</sup> / <sub>2</sub> × 31 <sup>1</sup> / <sub>2</sub>	865	84	FX80	250.50
Pisa,	S	5 × 21 <sup>3</sup> / <sub>4</sub>	"	82	"	79.25
Plymouth,	M1	14 × 2 <sup>7</sup> / <sub>8</sub>	*	*	AZ10	10.25
"	M2	10 <sup>7</sup> / <sub>8</sub> × 2 <sup>1</sup> / <sub>16</sub>	*	*	"	7.00
"	M3†	10 × 1 <sup>1</sup> / <sub>2</sub>	986	9	"	4.00
"	M4†	7 <sup>1</sup> / <sub>4</sub> × 1 <sup>1</sup> / <sub>2</sub>	*	*	"	2.75
"	C1†	14 × 8 <sup>1</sup> / <sub>2</sub> × 1 <sup>1</sup> / <sub>2</sub>	*	*	"	6.50
"	C2†	13 <sup>7</sup> / <sub>8</sub> × 9 <sup>1</sup> / <sub>2</sub> × 2 <sup>7</sup> / <sub>8</sub>	*	*	"	12.75
"	C3†	8 <sup>1</sup> / <sub>2</sub> × 8 <sup>1</sup> / <sub>2</sub> × 2 <sup>1</sup> / <sub>2</sub>	862	59	"	8.20
"	C4†	6 <sup>7</sup> / <sub>8</sub> × 6 <sup>7</sup> / <sub>8</sub> × 1 <sup>1</sup> / <sub>2</sub>	986	1	"	2.50
"	C5†	6 × 6 × 1 <sup>3</sup> / <sub>8</sub>	862	56	"	2.50
"	C6†	5 <sup>3</sup> / <sub>8</sub> × 5 <sup>3</sup> / <sub>8</sub> × 1 <sup>1</sup> / <sub>8</sub>	986	2	"	2.50
Prades,	S	3 × 10 <sup>1</sup> / <sub>2</sub>	866	96	CX22	8.25
Rialto,	C	12 <sup>1</sup> / <sub>4</sub> × 12 <sup>1</sup> / <sub>4</sub> × 2 <sup>3</sup> / <sub>4</sub>	865	89	"	24.75
Riva,	M	17 <sup>5</sup> / <sub>8</sub> × 27	860	40	FX80	33.25
Roanoke,	TB	17 <sup>3</sup> / <sub>4</sub> × 13 <sup>1</sup> / <sub>2</sub> × 4	*	*	"	12.25
"	M1	20 <sup>3</sup> / <sub>8</sub> × 4	*	*	"	10.50

\* Not illustrated.

† Suitable for Cabinet Doors.

Design.	Letters.	Size in ins.	Page.	Fig.	Finish.	Each.
Roanoke,	M2	$13\frac{3}{4} \times 13 \times 4$	*	*	FX80	\$15.25
"	C	$9 \times 9 \times 4\frac{1}{4}$	861	55	"	12.25
Rodez,	M	$24\frac{3}{8} \times 35$	860	44	"	108.50
Roquefort,	M	$13\frac{3}{4} \times 18\frac{3}{8}$	861	51	CX22	42.50
Royat,	M	$23\frac{3}{4} \times 26\frac{3}{4}$	860	41	"	58.75
Saarbruck,	S1†	$6\frac{1}{8} \times 23$	866	93	"	30.00
"	S2†	$6\frac{1}{8} \times 19$	"	94	"	24.00
"	M	$4\frac{1}{8} \times 19\frac{7}{8}$	*	*	"	25.50
"	M	$4\frac{1}{8} \times 23\frac{7}{8}$	*	*	"	31.50
Salignac,	TB	$17\frac{3}{4} \times 18\frac{1}{2} \times 3\frac{3}{8}$	864	77	"	18.00
Senlis,	TB	$18\frac{1}{2} \times 20\frac{1}{4} \times 5$	863	65	"	41.25
"	M	$20\frac{1}{4} \times 20$	"	69	"	42.25
Sevres,	TB	$16\frac{1}{8} \times 17\frac{1}{4} \times 4\frac{1}{4}$	858	29	CX22	38.00
"	M1†	$8\frac{1}{2} \times 1\frac{3}{4}$	*	*	"	4.50
"	M2	$4\frac{1}{4} \times 11\frac{1}{4}$	858	25	"	17.25
Tarbes,	TB	$23\frac{1}{2} \times 18 \times 8\frac{3}{4}$	856	2	FX80	59.25
Toulon,	TB1†	$7\frac{1}{2} \times 14$	*	*	AZ10	7.75
"	TB2†	$7\frac{1}{2} \times 13\frac{7}{8}$	*	*	"	7.75
"	TB3†	$7\frac{1}{2} \times 13\frac{3}{4}$	*	*	"	7.75
"	TB4†	$7\frac{1}{4} \times 8\frac{7}{8}$	990	7&8	"	5.00
"	TB5†	$6\frac{1}{8} \times 12\frac{1}{2}$	"	1	"	4.50
"	TB6†	$6\frac{1}{8} \times 5\frac{1}{4}$	*	*	"	3.50
"	TB7†	$4\frac{7}{8} \times 9\frac{1}{2}$	990	2&3	"	3.50
"	TB8†	$2\frac{1}{2} \times 4\frac{1}{2}$	"	6	"	2.00
"	M1†	$3\frac{1}{8} \times 2\frac{3}{4}$	"	4	"	2.25
"	M2†	$2\frac{3}{4} \times 2\frac{1}{4}$	*	*	"	2.50
Tours,	TB†	$6\frac{1}{2} \times 4\frac{3}{8} \times 1\frac{3}{4}$	989	1	CX22	4.75
"	M†	$6\frac{5}{8} \times 1\frac{3}{4}$	"	4	"	3.25
Traves,	TB1†	$8\frac{1}{2} \times 5\frac{1}{2} \times 2$	991	7&8	AZ10	3.50
"	TB2†	$6 \times 5\frac{1}{8} \times 2\frac{1}{2}$	"	6	"	3.75

\* Not illustrated. † Suitable for Cabinet Doors

Design.	Letters.	Size in ins.	Page.	Fig.	Finish.	Each.
Traves,	S1†	$7 \times 5\frac{5}{8} \times 2\frac{1}{2}$	991	4&5	AZ10	\$ 7.75
"	S2†	$5 \times 4\frac{5}{8} \times 2$	"	1&2	"	7.25
Treviso,	TB1	$15\frac{1}{4} \times 15\frac{1}{4} \times 3$	858	21	GY10	139.75
"	TB2	$15\frac{1}{4} \times 15\frac{1}{4} \times 3\frac{3}{4}$	*	*	"	139.75
"	M1	$15\frac{1}{4} \times 3$	*	*	"	93.00
"	M2	$15\frac{1}{4} \times 3\frac{3}{4}$	*	*	"	93.00
Tulle,	TB	$12 \times 22\frac{3}{4}$	857	11	CX22	26.50
Urbino,	TB1†	$5\frac{1}{2} \times 4\frac{1}{2} \times 1\frac{1}{8}$	*	*	"	5.50
"	TB2†	$7\frac{5}{8} \times 6\frac{3}{4} \times 1\frac{1}{8}$	987	1&2	"	5.50
"	TB3†	$8\frac{1}{4} \times 8\frac{1}{4} \times 2$	"	9&10	"	13.75
"	TB4	$16\frac{5}{8} \times 12\frac{3}{4} \times 3\frac{1}{8}$	865	85	"	23.50
"	TB5†	$6\frac{1}{2} \times 5\frac{1}{2} \times 1\frac{1}{8}$	*	*	"	5.50
"	M1†	$6 \times 1\frac{1}{8}$	987	7	"	3.75
"	M2	$17\frac{3}{4} \times 3\frac{1}{8}$	865	86	"	20.25
"	M3	$15\frac{3}{4} \times 3\frac{3}{16}$	*	*	"	13.75
"	C1	$16\frac{5}{8} \times 12\frac{3}{4} \times 3\frac{1}{8}$	865	83	"	23.50
"	C2†	$5 \times 5 \times 1\frac{1}{8}$	*	*	"	5.50
Valence,	TB†	$5\frac{7}{8} \times 5\frac{1}{4} \times 1\frac{1}{2}$	989	1	"	4.75
"	M1†	$6\frac{1}{8} \times 1\frac{1}{4}$	"	4	"	3.25
"	M2†	$6 \times 1\frac{1}{2}$	*	*	"	3.25
"	M3†	$1\frac{3}{4} \times 10\frac{1}{8}$	*	*	"	3.25
Vancluse,	TB	$8\frac{1}{2} \times 8\frac{1}{2} \times 5$	861	49	FX80	42.00
Vignory,	M	$17 \times 5$	857	17	"	35.00

\* Not illustrated.

† Suitable for Cabinet Doors.



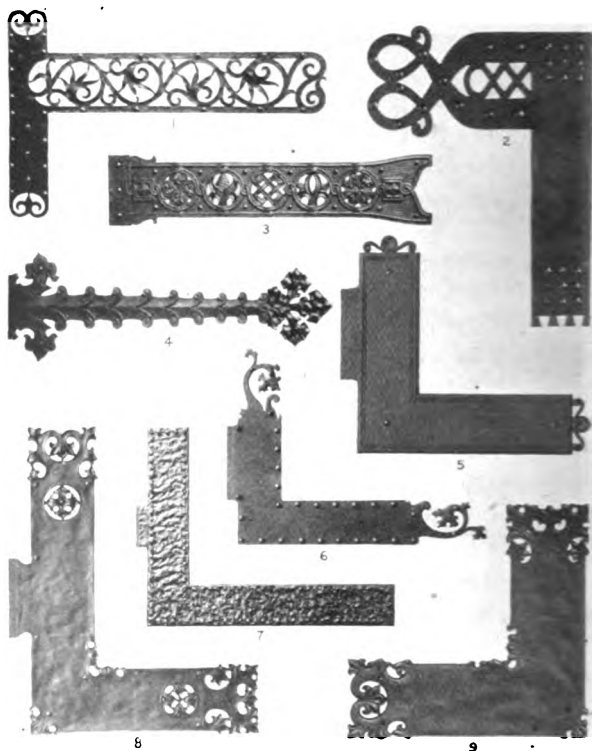

## Hinge and Corner Plates.

Fig.	Design.	Page.	Fig.	Design.	Page.	Fig.	Design.	Page.
1,	Agen, . . .	847	4,	Dieppe, . . .	850	7,	Donjon, . . .	850
2,	Tarbes, . . .	854	5,	Amherst, . . .	847	8,	Auvergne, . . .	848
3,	Duxbury, . . .	850	6,	Amiens, . . .	847	9,	Auvergne, . . .	848

For dimensions of these Hinge and Corner Plates and prices each see pages 847 to 855. For alphabetical list of Designs showing Schools see page 244.

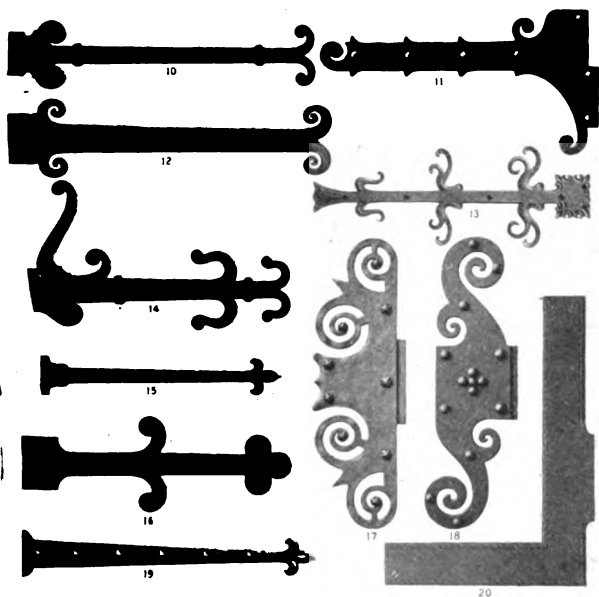

Hinge and Corner Plates.

Fig.	Design.	Page.	Fig.	Design.	Page.	Fig.	Design.	Page.
10,	Brionde,	849	14,	Brionde,	849	18,	Bordeaux,	848
11,	Tulle,	855	15,	Cydonia,	850	19,	Cydonia,	850
12,	Bayonne,	848	16,	Aspremont,	847	20,	Hingham,	851
13,	Murat,	853	17,	Vignory,	855			

For Dimensions of these Hinge and Corner Plates and prices each see pages 847 to 855. For alphabetical list of Designs showing Schools see page 244.

Section.  
1. 1

2. Ty  
C  
C

3. Stro  
F  
G

4. TYPE  
O  
R

The Car





33



35

37

## Hinge and Corner Plates.

Page	Fig.	Design.	Page.	Fig.	Design.	Page.
851	34,	Cherbourg,	849	36,	Pau, . . .	853
848	35,	Marly, . .	852	37,	Marly, . . .	852
852						

For these Hinge and Corner Plates and prices each see pages 847 to 852 and list of Designs showing Schools see page 244.



### Hinge and Corner Plates.

Fig.	Design.	Page.	Fig.	Design.	Page.	Fig.	Design.	Page.
21,	Treviso,	855	25,	Sevres,	854	28,	Beauvais,	841
22,	Nantes,	853	26,	Dresden,	850	29,	Sevres,	854
23,	Aubigny,	847	27,	Beauvais,	848	30,	Beauvais,	841
24,	Adams,	847						

For dimensions of these Hinge and Corner Plates and prices each see pages 847-855. For alphabetical list of Designs showing Schools see page 244.

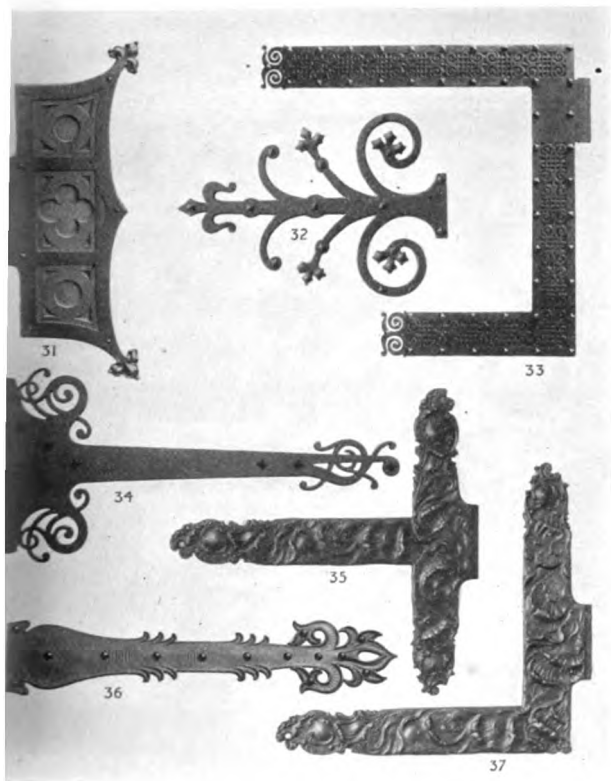

Hinge and Corner Plates.

Design.	Page	Fig.	Design.	Page	Fig.	Design.	Page.
, Granville,	. 851	34,	Cherbourg,	849	36,	Pau,	. . 853
, Bernay,	. 848	35,	Marly,	. 852	37,	Marly,	. . 852
, Leicester,	. 852						

For dimensions of these Hinge and Corner Plates and prices each see pages 847 to 852. For alphabetical list of Designs showing Schools see page 244.



### Hinge and Corner Plates.

Fig.	Design.	Page.	Fig.	Design.	Page.	Fig.	Design.	Page.
38,	Melun,	852	41,	Royat,	854	44,	Rodez,	854
39,	Montins,	853	42,	Archala,	847	45,	Milan,	852
40,	Riva,	853	43,	Gironde,	851	46,	Jena,	851

For dimensions of these Hinge and Corner Plates and prices each see pages 847 to 855. For alphabetical list of Designs showing Schools see page 244.

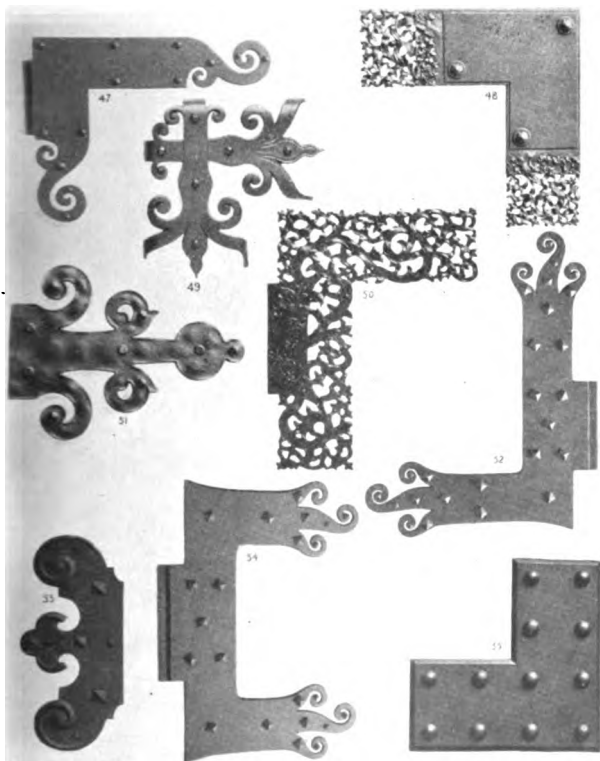

## Hinge and Corner Plates.

Fig.	Design.	Page.	Fig.	Design.	Page.	Fig.	Design.	Page.
47,	Bordeaux, .	848	50,	Kelp, . .	851	53,	Hamburg,	851
48,	Kelp, . .	851	51,	Roquefort,	854	54,	Bourg, .	848
49,	Vancluse, .	855	52,	Bourg, .	848	55,	Roanoke, .	854

For dimensions of these Hinge and Corner Plates and prices each see pages 847 to 855. For alphabetical list of Designs showing Schools see page 244.



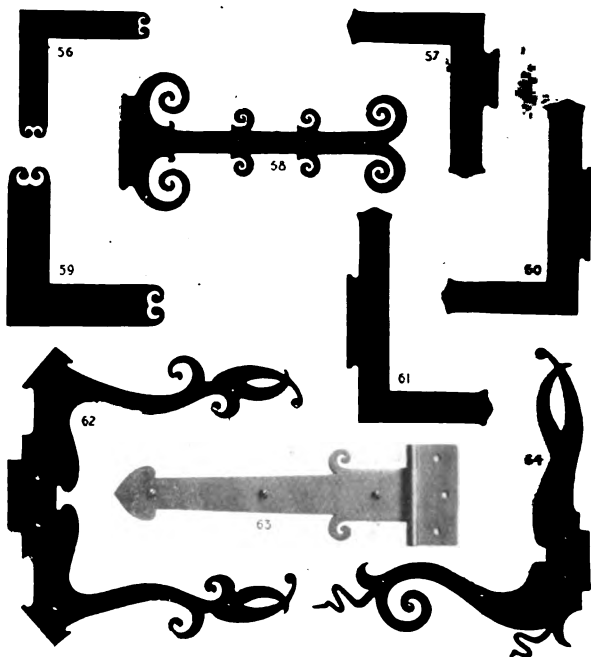

## Hinge and Corner Plates.

Fig.	Design.	Page.	Fig.	Design.	Page.	Fig.	Design.	Page.
56,	Plymouth,	853	59,	Plymouth, .	853	62,	Novara,	855
57,	Cluny, . .	849	60,	Cluny, . .	849	63,	Nahant,	855
58,	Foix, . . .	850	61,	Cluny, . .	849	64,	Novara,	855

For dimensions of these Hinge and Corner Plates and prices each see pages 847 to 855. For alphabetical list of Designs showing Schools see page 244.

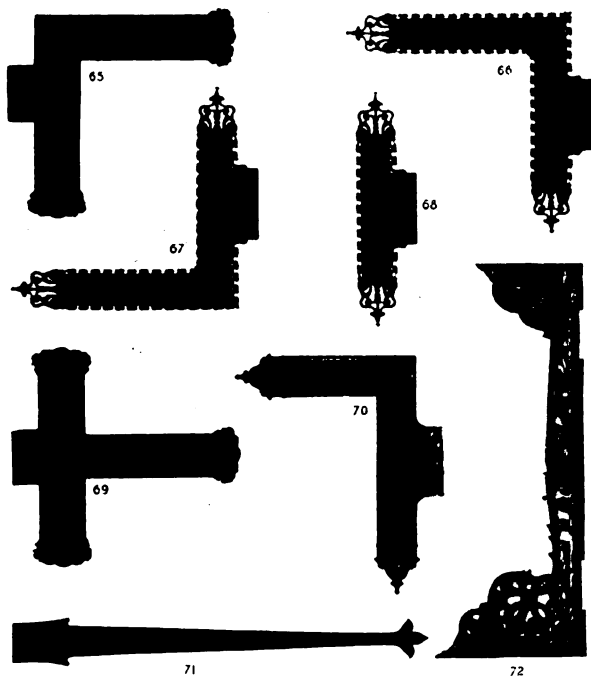

## Hinge and Corner Plates.

Fig.	Design.	Page.	Fig.	Design.	Page.	Fig.	Design.	Page.
65,	Senlis, . .	854	68,	Manchester,	852	71,	Bennington,	848
66,	Manchester,	852	69,	Senlis, . .	854	72,	Elne. . .	850
67,	Manchester,	852	70,	Bergamo, .	848			

For dimensions of these Hinge and Corner Plates and prices each see pages 847 to 855. For alphabetical list of Designs showing Schools see page 244.

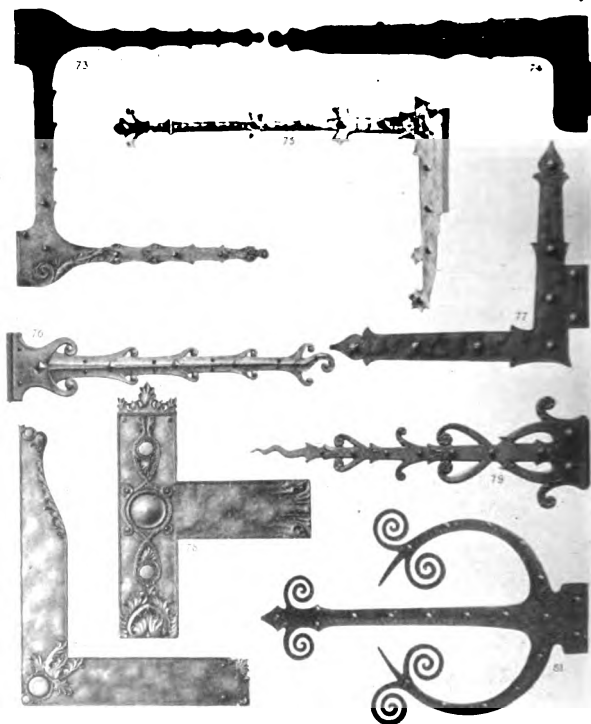

## Hinge and Corner Plates.

Fig.	Design.	Page.	Fig.	Design.	Page.	Fig.	Design.	Page.
75,	Narbonne, .	853	76,	Duranno, .	850	79,	Brest, . .	849
74,	Margaux, .	852	77,	Salignac, .	854	80,	Beaucaire, .	848
73,	Margaux, .	852	78,	Beaucaire,	848	81,	Chalons, .	894

For dimensions of these Hinge and Corner Plates and prices each see pages 847 to 855. For alphabetical list of Designs showing Schools see page 244.

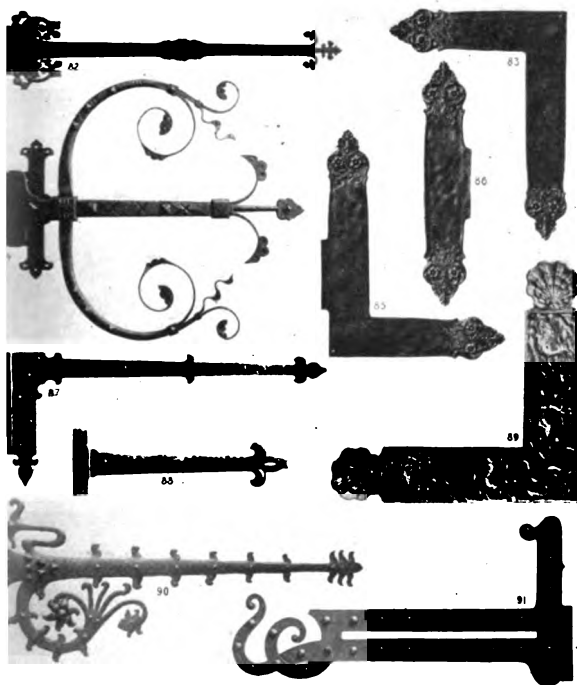

## Hinge and Corner Plates.

Design.	Page.	Fig.	Design.	Page.	Fig.	Design.	Page.
Pisa, . . .	853	86,	Urbino, . . .	855	89,	Rialto, . . .	853
Urbino, . . .	855	87,	Greenfield, . . .	851	90,	Flavigny, . . .	850
Pesaro, . . .	853	88,	Cydonia, . . .	850	91,	Durban. . .	850
Urbino, . . .	855						

r dimensions of these Hinge and Corner Plates and prices each see pages 847 to  
For alphabetical list of Designs showing Schools see page 244.

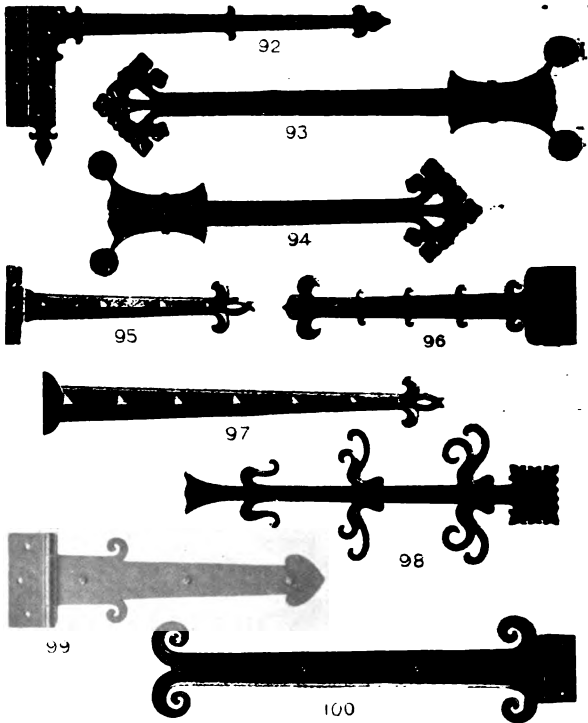

Hinge and Corner Plates.

Fig.	Design.	Page.	Fig.	Design.	Page.	Fig.	Design.	Page.
92,	Greenfield,	851	95,	Cydonia,	850	98,	Murat,	8:
93,	Saarbruck, .	854	96,	Prades,	853	99,	Nahant,	8:
94,	Saarbruck, .	854	97,	Cydonia,	850	100,	Bayonne .	84

For dimensions of these Hinges and Corner Plates and prices each see pages 847-855. For alphabetical list of Designs showing Schools see page 244.

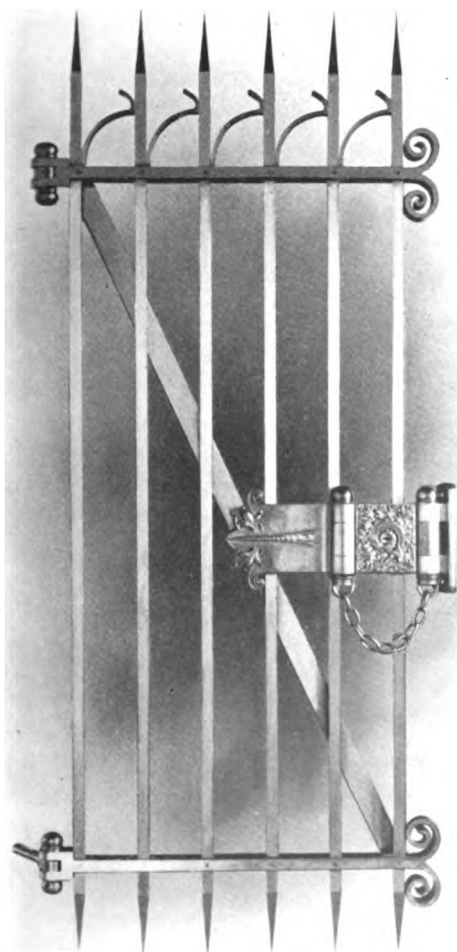

**Ornamental Lock on Grille Door.**

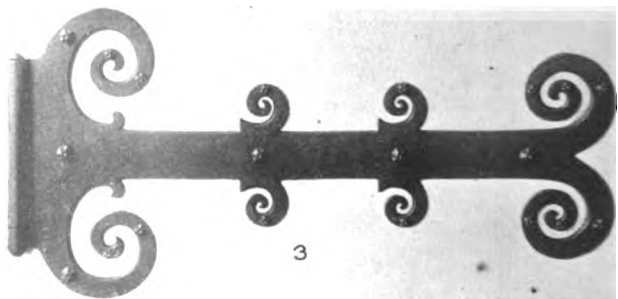
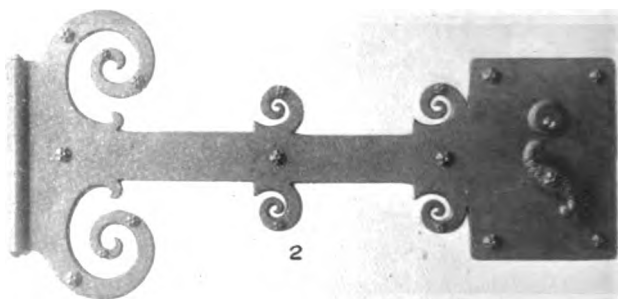
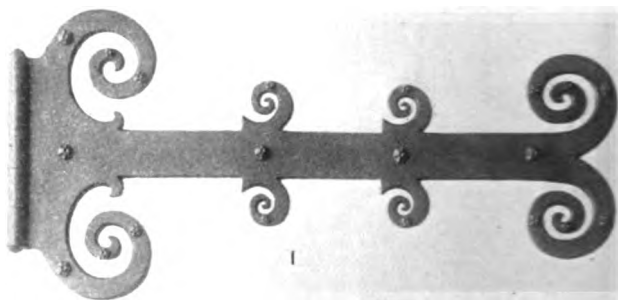

**Combined Escutcheon and Hinge Plates.**

**Figs. 1 and 3, Top and Bottom Hinge Plates. Fig. 2, Combined Hinge and Escutcheon Plate.**



Combined Escutcheon and Hinge Plates.

Fig. 1, Top Hinge Plate. Fig. 2, Combined Hinge and Escutcheon Plate. Fig. 3, Bottom Hinge (or Kick) Plate.



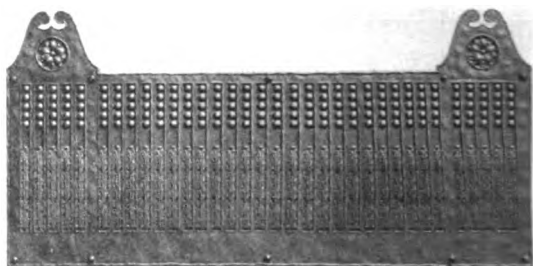

1



2

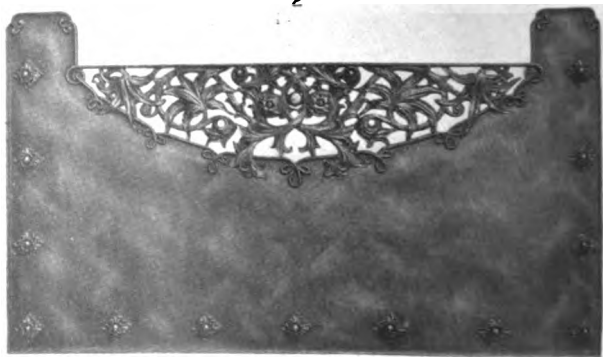

3

**Ornamental Kick Plates.****Made from architect's designs.**

Digitized by Google



1

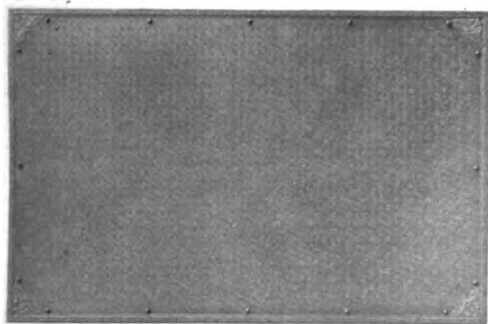

2

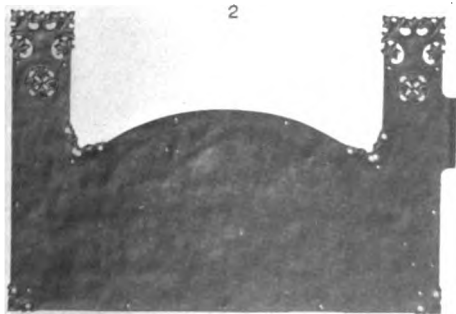

3

**Ornamental Kick Plates.**  
Made from architect's designs.

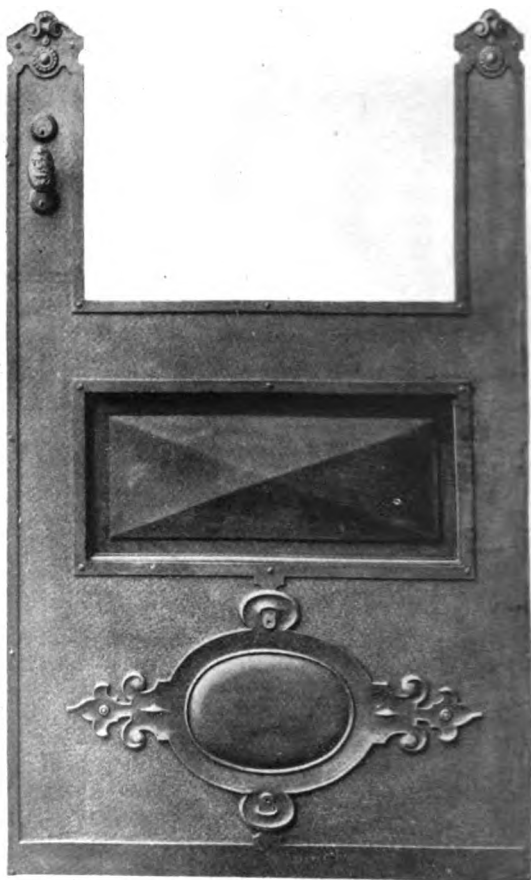

**Combined Escutcheon and Kick Plate.**

Made from architect's design.

## Section 6.

### Door Knockers.

For information as to other pieces in these Designs see alphabetical list of all Designs, page 244.

For article on "Metals and Finishes" see page 595, and for Nomenclature of Finishes and Explanation of Finish Symbols see page 609.

See note as to method of pricing, page 33.

Design.	No.	Size in ins.	Page.	Fig.†	Finish.	Each.
Adams, . . .	1425	12 $\frac{5}{8}$ X 3 $\frac{7}{8}$	*	*	AZ10	\$33.50
Alencon, . . .	"	2 $\frac{1}{2}$ X 8	874	10	CX22	26.50
Andover, . . .	"	2 diam.	"	4	CY22	22.25
Auvergne, . . .	"	8 $\frac{1}{2}$ X 2 $\frac{3}{4}$	875	18	CX22	17.50
Bellas, . . .	"	4 $\frac{1}{2}$ X 4 $\frac{1}{2}$	874	11	"	20.50
Dunkirk, . . .	"	2 diam.	"	1	"	27.00
Evereux, . . .	"	4 X 4	"	3	FX80§	33.00
Gueret, . . .	"	9 $\frac{1}{2}$ X 6 $\frac{1}{2}$	594c	31	"	25.00
Leghorn, . . .	"	9 $\frac{1}{8}$ X 5	874	9	CY22	18.50
Marlaix, . . .	"	5 $\frac{3}{4}$ X 10	"	12	"	22.00
Messina, . . .	"	9 $\frac{3}{4}$ X 3 $\frac{3}{8}$	875	22	"	26.00
Modena, . . .	"	11 X 6 $\frac{3}{8}$	"	21	CX22	73.25
Orleans, . . .	"	8 $\frac{1}{4}$ diam.	"	20	"	41.50
Paris, . . .	"	7 $\frac{3}{4}$ X 5 $\frac{7}{8}$	"	19	CY22	34.00
Plymouth, . . .	"	8 X 2 $\frac{1}{2}$	"	17	BZ10	7.75
Reggio, . . .	"	8 $\frac{1}{2}$ X 5 $\frac{1}{2}$	594c	30	CX22	55.00
Roanoke, . . .	"	9 $\frac{1}{2}$ X 9 $\frac{1}{2}$	874	8	BZ10	42.25
St. Denis, . . .	"	12 $\frac{1}{4}$ diam.	875	13	FX80§	100.00
Taranto, . . .	"	7 X 5 $\frac{1}{2}$	"	23	"	57.25
Terni, . . .	"	8 $\frac{1}{4}$ diam.	874	5	CX22	138.50
Tivoli, . . .	"	10 $\frac{3}{8}$ "	875	15	"	183.50
Trento, . . .	"	8 $\frac{1}{4}$ X 5	874	6	FX80§	94.00
Trouville, . . .	"	3 $\frac{1}{4}$ diam.	"	2	FX80§	102.50
Turin, . . .	"	8 $\frac{1}{2}$ X 6	875	14	CX22	44.50
Verzy, . . .	"	5 $\frac{1}{4}$ X 5 $\frac{1}{2}$	874	7	CY22	35.50

\* Not illustrated.

† Figs. 16, 24, 25, 26 and 27 Special.

§ Wrought iron.

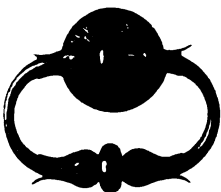

5



4



3



6



7

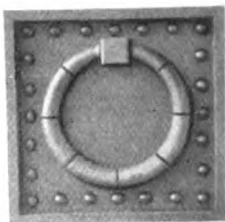

8



9



10



11



12

Door Knockers.

For dimensions and prices see page 873.



13



14



15



16



17



18



19



20



21



22



23



24



25



26



27

Door Knockers.

For dimensions and prices see page 873.



2

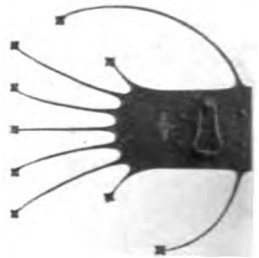

3



4



5



6



7



8



9

Combined Escutcheon Plates and Ring Pulls.

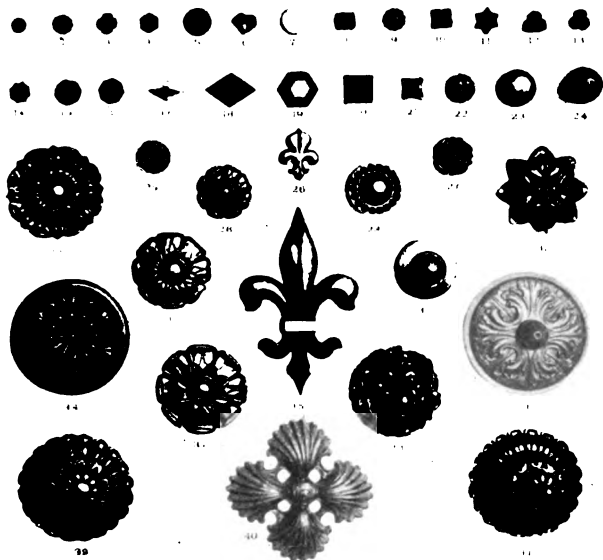

Ornamental Nails and Studs.

Mediæval practice involved the use of wrought Nails or Studs to fasten together the component parts of heavy wooden doors, and the heads of these nails were frequently of ornamental form. The Studs were also often arranged in geometric lines as a feature of decoration, either separately or in connection with the other metal work of the door.

Although the constructive necessity for these Studs has disappeared under modern methods of wooden construction, they are still used for the purposes of decoration. A great variety of ornamental Nails and Studs is made for this purpose, of which a few examples are shown above.

They are made in various metals and finishes, with a projecting spur on the back which can be driven into the wood, thus firmly attaching the ornamental head in place. When properly introduced they contribute very effectively to the decoration of important doors, and are especially appropriate to the exterior doors of churches and public buildings.





FLEURY



FIRENZE



CERTOSA



CAMBRIA

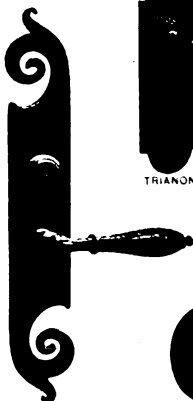

BORDEAUX



TRIANON



FONTENAY



CHATELAIN



CASALE



B'ARRITZ

### Ornamental Lever Handles.

Illustrations about  $\frac{1}{4}$  size.

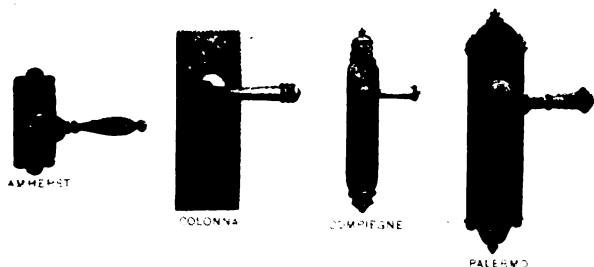

Illustrations about  $\frac{1}{8}$  size.

### Ornamental Lever Handles.

For information as to other pieces in these Designs see alphabetical list of all Designs, page 244.

For Designs arranged by Schools see page 236.

The lever handles here shown may be associated with various plates, but for purpose of specifying they should be referred to by the names here given.

Design	No.	School	Size.	Page.*
Amherst, . . . . .	35	Colonial, . . . . .	4 inches,	548
Biarritz, . . . . .	"	French Renaissance,	5 "	507
Bordeaux, . . . . .	"	Romanesque, . . . . .	6 "	398
Cambria, . . . . .	"	Modern, . . . . .	4 $\frac{3}{4}$ "	581
Casale, . . . . .	"	Greek, . . . . .	5 "	335
Certosa, . . . . .	"	Italian Renaissance,	4 $\frac{1}{8}$ "	424
Chatillon, . . . . .	"	Louis XVI, . . . . .	3 $\frac{1}{2}$ "	537
Colonna, . . . . .	"	Colonial, . . . . .	3 "	550
Compiègne, . . . . .	"	Louis XVI, . . . . .	1 $\frac{1}{2}$ "	537
Firenze, . . . . .	"	Italian Renaissance,	3 $\frac{3}{4}$ "	425
Fleury, . . . . .	"	Louis XV, . . . . .	3 $\frac{3}{4}$ "	531
Fontenoy, . . . . .	"	Louis XV, . . . . .	4 $\frac{1}{4}$ "	531
Palermo, . . . . .	"	Italian Renaissance,	3 $\frac{1}{4}$ "	427
Trianon, . . . . .	"	Louis XVI, . . . . .	3 $\frac{5}{8}$ "	537

Glass Lever Handle illustrated on page 594B, Fig. 17.

\* References are to pages showing additional pieces in the various Designs, and approximate prices.

1 2 3 4 5 6  
7 8 9 0

Series A.

Made as follows : 1,  $1\frac{1}{4}$ , 2,  $2\frac{1}{2}$ , 3,  $4\frac{3}{8}$ ,  $6\frac{1}{8}$  and 10 inches high.

1 2 3 4 5 6  
7 8 9 0

Series B.

Made as follows : 2,  $3\frac{5}{8}$  and  $4\frac{7}{8}$  inches high.

Specify whether figures are to be attached to wood or stone.

Sizes over 4 inches are regularly furnished with screws ; smaller sizes with nails cast in the back.

See Note as to Method of Pricing, page 33.

1 2 3 4 5 6  
7 8 9 0

Series C.  
Made  $4\frac{5}{8}$  inches high.

1 2 3 4 5 6  
7 8 9 0

Series D.  
Made as follows:  $\frac{5}{8}$  and  $1\frac{5}{8}$  inches high.

Specify whether figures are to be attached to wood or stone.

Sizes over 4 inches are regularly furnished with screws; smaller sizes with nails cast in the back.

See Note as to Method of Pricing, page 33.

1 2 3 4 5 6  
7 8 9 0

Series E.

Made  $1\frac{1}{4}$  inches high.

1 2 3 4 5 6  
7 8 9 0

Series F.

Made  $4\frac{1}{8}$  inches high.

Specify whether figures are to be attached to wood or stone.

Sizes over 4 inches are regularly furnished with screws: smaller sizes with nails cast in the back.

*See Note as to Method of Pricing, page 33.*

1 2 3 4 5 6  
7 8 9 0

Series G.

Made 6 inches high.

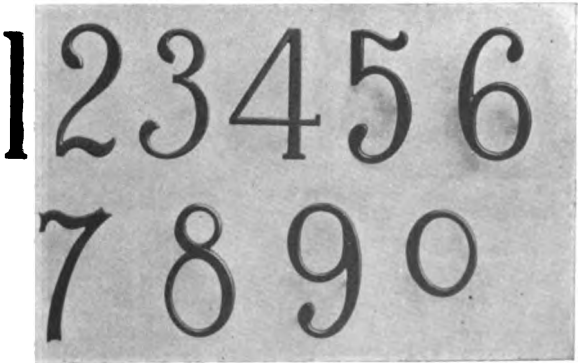

Series H.

Made 2 3/4 inches high.

Specify whether figures are to be attached to wood or stone.

Sizes over 4 inches are regularly furnished with screws ; smaller sizes with nails cast in the back.

See Note as to Method of Pricing, page 33.

1 2 3 4 5 6  
7 8 9 0

## Series I.

Made  $1\frac{1}{4}$  inches high.

1 2 3 4 5 6  
7 8 9 0

## Series K.

Made  $5\frac{3}{8}$  inches high.

Specify whether figures are to be attached to wood or stone.

Sizes over 4 inches are regularly furnished with screws; smaller sizes with nails cast in the back.

*See Note as to Method of Pricing, page 33.*

A B C D E  
F G H I J K  
L M N O P,  
Q R S T U  
V W X Y Z

Series No. 1.

Made as follows :  $\frac{3}{4}$  and 2 inches high.

Specify whether letters are to be attached to wood or stone.

See Note as to Method of Pricing, page 33.



A B C D E  
F G H

Series No. 2.  
Made 4 inches high.

A B C D E  
F G H

Series No. 3.  
Made 4<sup>1</sup>/<sub>8</sub> inches high.

Specify whether letters are to be attached to wood or stone.

*See Note as to Method of Pricing, page 33.*

## Section 12.

---

### Cremorne, Espagnolette and Extension Bolts.

Ornamental Cremorne Bolts, illustrated on pages 889 to 892, and priced on pages 887 and 888.

Ornamental Espagnolette Bolts, illustrated on page 893, and priced on page 888.

Ornamental Extension Bolts, illustrated on page 894, and priced on page 888.

Plain Cremorne Bolts, illustrated on page 889, and priced below.

Plain Espagnolette Bolts, illustrated and priced on page 771.

Plain Extension Bolts, illustrated and priced on pages 765 to 770.

For Designs arranged by Schools, see page 236.

For explanatory article see page 186.

For information as to other pieces in these designs see alphabetical list of all Designs, page 244.

For article on "Metals and Finishes" see page 595, and for Nomenclature of Finishes and explanation of Finish symbols used below see page 609.

See note as to method of pricing, page 33.

#### CREMORNE BOLTS (HALF-ROUND ROD)

Design.	No.	Case, in ins.	Page.	Fig.	Finish.	Each.
Chartres, . . . . .	893	6 <sup>5</sup> / <sub>8</sub> × 1 <sup>1</sup> / <sub>2</sub>	891	11	SY52	\$46.25
Chatillon, . . . . .	"	7 <sup>7</sup> / <sub>8</sub> × 1 <sup>5</sup> / <sub>8</sub>	"	14	AZ15	54.50
" . . . . .	895	" "	"	15	"	54.50
Dreux, . . . . .	893	6 <sup>3</sup> / <sub>8</sub> × 1 <sup>1</sup> / <sub>2</sub>	890	8	CX22	33.50
" . . . . .	894	8 × 1 <sup>1</sup> / <sub>2</sub>	"	10	"	33.50
" . . . . .	895	6 <sup>3</sup> / <sub>8</sub> × 1 <sup>1</sup> / <sub>2</sub>	"	9	"	33.50
Fairfax, . . . . .	893	6 <sup>5</sup> / <sub>8</sub> × 1 <sup>1</sup> / <sub>2</sub>	"	6	BZ10	41.50
" . . . . .	895	" "	"	7	"	44.75
Fleury, . . . . .	893	6 <sup>5</sup> / <sub>8</sub> × 1 <sup>3</sup> / <sub>4</sub>	891	12	CX22	33.50
" . . . . .	895	" "	"	13	"	33.50
Lancaster, . . . . .	893	6 <sup>5</sup> / <sub>8</sub> × 1 <sup>1</sup> / <sub>2</sub>	889	1	AZ10	26.50
" . . . . .	895	" "	"	5	"	26.50
Plain, . . . . .	893	6 <sup>3</sup> / <sub>8</sub> × 1 <sup>1</sup> / <sub>2</sub>	"	2	BZ10	13.25
" . . . . .	894	8 × 1 <sup>1</sup> / <sub>2</sub>	"	3	"	15.50
" . . . . .	895	6 × 1 <sup>1</sup> / <sub>2</sub>	"	4	"	20.00

## CREMORNE BOLTS (SOLID-ROUND ROD).

Design.	No.	Case, in ins.	Page.	Fig.	Finish.	Each.
Chatillon, . . .	896	8 $\frac{3}{4}$ X 2	892	17	AZ15	\$176.00
Vergennes, . . .	"	8 $\frac{3}{8}$ X 2	"	18	CX22	174.50
Weyanoke, . . .	"	7 $\frac{1}{4}$ X 2	"	16	BZ10	122.00

## ESPAGNOLETTE BOLTS (SOLID-ROUND ROD).

Design.	No.	Case, in ins.	Page	Fig	Finish.	Each.
Chatillon, . . .	883	7 $\frac{1}{2}$ X 1 $\frac{1}{2}$	893	3	AZ15	\$134.00
Guilford, . . .	881	For 1 $\frac{1}{4}$ in. Stile	"	5	AZ10	12.25
Heidelberg, . . .	882	For 2 in Stile	"	4	CX22	26.50
Vergennes, . . .	883	7 $\frac{1}{4}$ X 1 $\frac{5}{8}$	"	2	"	161.00
Weyanoke, . . .	"	6 $\frac{1}{2}$ X 1 $\frac{3}{8}$	"	1	BZ10	94.50

## EXTENSION BOLTS.\*

Design.	No.	Case, in ins.	Page.	Fig.	Finish.	Each.
Cluny, . . . . .	788	6 $\frac{1}{8}$ X 2	894	7	CX22	\$3 40
Hingham, . . . .	"	6 $\frac{1}{8}$ X 1 $\frac{1}{2}$	"	5	BZ10	4.25
Lodi, . . . . .	"	6 $\frac{7}{8}$ X 1 $\frac{5}{8}$	"	3	CX22	6.00
Lynn, . . . . .	"	6 X 1 $\frac{1}{2}$	"	4	BZ10	4.25
Lyons, . . . . .	"	5 $\frac{3}{4}$ X 1 $\frac{5}{8}$	"	8	CX22	5.25
Plymouth, . . . .	"	6 $\frac{1}{4}$ X 1 $\frac{1}{2}$	"	1	BZ10	4.25
Realmont, . . . .	"	6 $\frac{1}{8}$ X 1 $\frac{7}{8}$	"	2	CX22	5.00
Rokeby, . . . . .	"	6 X 1 $\frac{3}{4}$	"	6	"	5.50

\* The Extension Bolts here shown are intended only as examples of the large number of Ornamental Bolts made in the various designs, and listed in Part III.

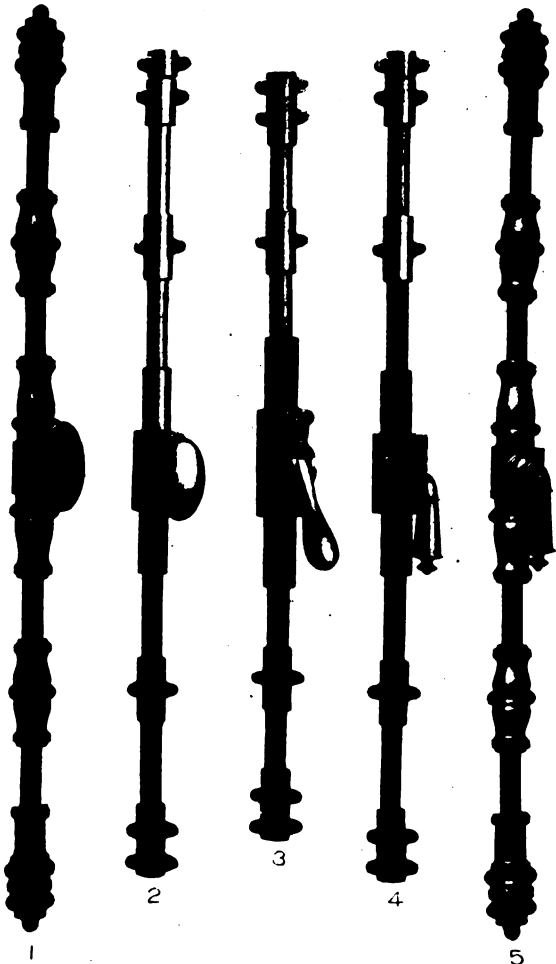

Plain and Ornamental Cremorne Bolts.

For prices see page 887. Illustrations about one-sixth size.

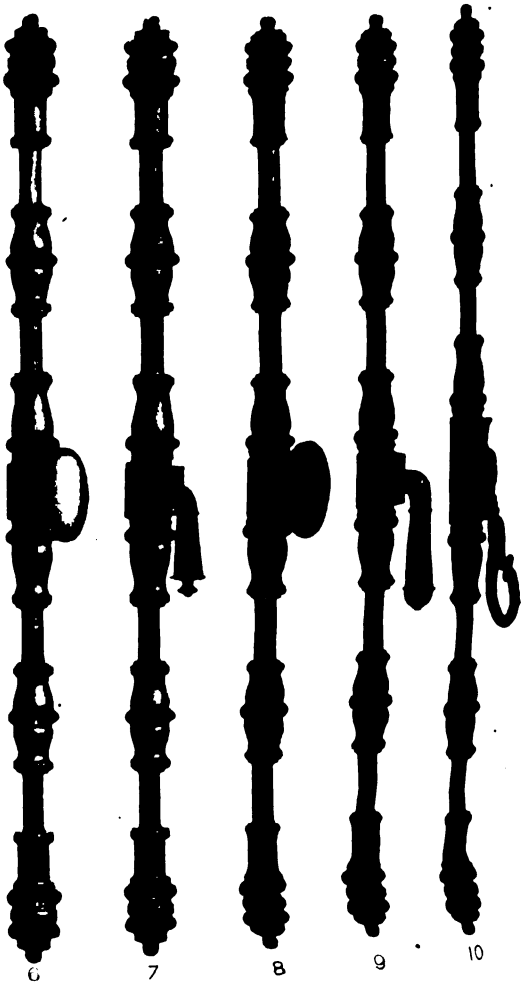

Ornamental Cremorne Bolts.  
For prices see page 887. Illustrations about one-sixth size.

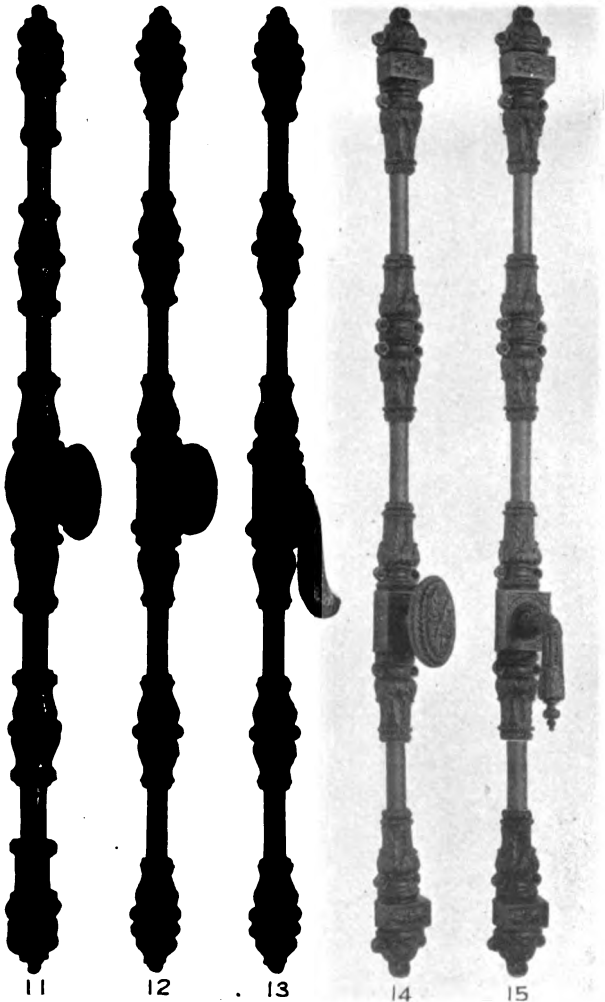

11

12

13

14

15

Ornamental Cremorne Bolts.

For prices see page 887. Illustrations about one-sixth size.

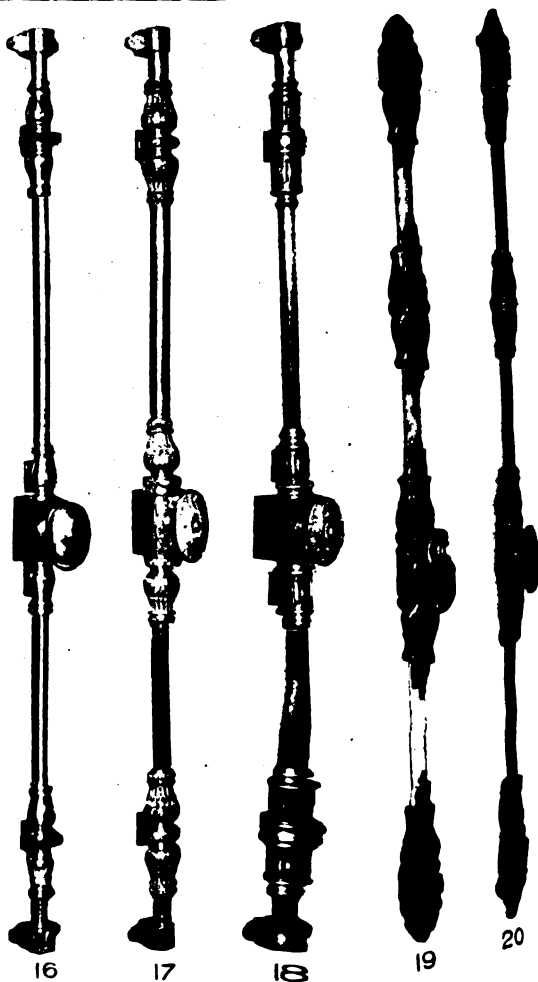

Ornamental Cremorne Bolts.

For prices see page 888. Illustrations about  $\frac{1}{4}$  size. Fig. 19 and 20 spec.

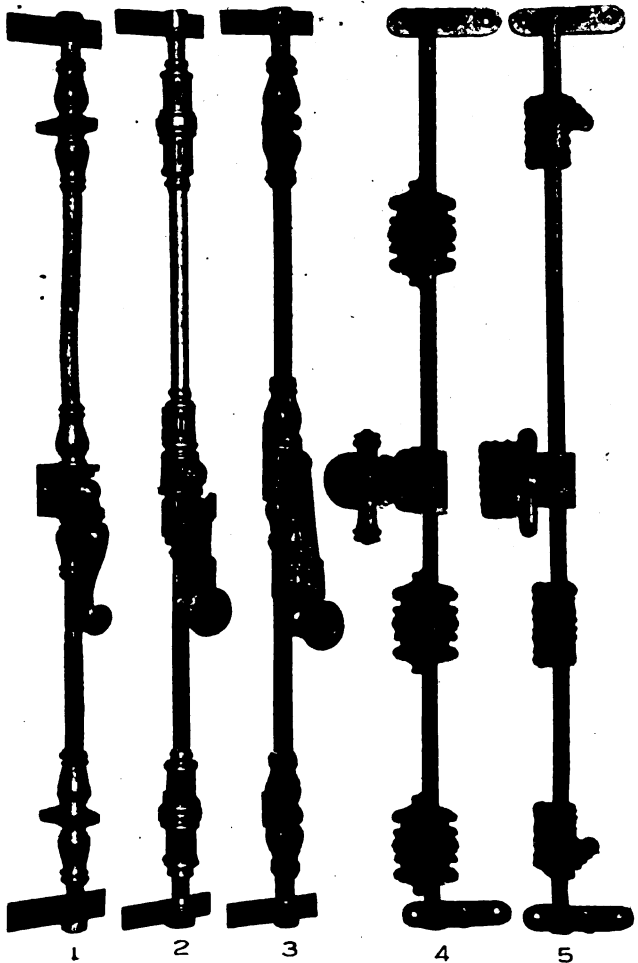

Ornamental Espagnolette Bolts.

For prices see page 888. Illustrations about  $\frac{1}{8}$  size.





1



2



3



4



5



6



7



8

### Ornamental Extension Bolts.

For prices, see page 888. Illustrations about  $\frac{1}{2}$  size.

## Section 13.

### Electric Push Buttons.

Ornamental Push Buttons illustrated on pages 898 to 903. For clue to prices see pages 33 and 244.

Plain Push Buttons illustrated on page 903 and priced on page 897.

For information as to other pieces in these Designs see alphabetical list of all Designs on page 244.

For Designs arranged by Schools see page 236.

Design.	Size in ins.	Page.	Fig.	Design.	Size in ins.	Page.	Fig.
Adams, . . .	$10\frac{1}{4} \times 3$	898	1	Bonn, . . .	$6 \times 2\frac{7}{8}$	899	20
Adria, . . .	$8\frac{1}{2} \times 3\frac{3}{4}$	"	3	Bordeaux, . . .	$6 \times 2\frac{1}{2}$	898	18
Alcazar, . . .	$7\frac{1}{4} \times 2\frac{1}{2}$	"	14	Bothnian, . . .	$4\frac{3}{4} \times 2\frac{1}{4}$	"	17
Alencon, . . .	$8 \times 2\frac{1}{2}$	"	4	Brabant, . . .	$4\frac{7}{8} \times 2$	903	108
Amboise, . . .	$5\frac{3}{4} \times 2\frac{1}{8}$	"	2	Bristol, . . .	$4\frac{7}{8} \times 2\frac{1}{4}$	898	11
Amherst, . . .	$6 \times 2\frac{5}{8}$	*	*	Brunswick, . . .	$4\frac{1}{4} \times 2\frac{1}{4}$	*	*
Amherst, . . .	$4\frac{5}{8} \times 2$	898	19	Cambria, . . .	$7\frac{3}{8} \times 2\frac{3}{8}$	899	36
Amiens, . . .	$12 \times 2\frac{7}{8}$	"	15	Castilian, . . .	$4 \times 1\frac{3}{4}$	"	33
Antwerp, . . .	$7\frac{1}{4} \times 3$	"	13	Certosa, . . .	$6\frac{1}{4} \times 2\frac{7}{8}$	903	112
Arcadian, . . .	$4 \times 1\frac{3}{4}$	"	5	Charrbord, . . .	$7 \times 2\frac{5}{8}$	899	38
Argos, . . .	$4\frac{5}{8} \times 3$	"	8	Chantilly, . . .	$7\frac{5}{8} \times 2\frac{1}{2}$	"	27
Arlington, . . .	$5\frac{1}{8} \times 2\frac{1}{2}$	"	9	Chatillon, . . .	$3\frac{5}{8} \times 1\frac{7}{8}$	"	34
Arno, . . .	$5 \times 1\frac{3}{4}$	"	7	Chester, . . .	$4\frac{7}{8} \times 2\frac{1}{4}$	"	26
Austerlitz, . . .	$7\frac{1}{4} \times 2\frac{1}{8}$	*	*	Cluny, . . .	$4\frac{1}{2} \times 1\frac{1}{2}$	732	11
Austerlitz, . . .	$7\frac{1}{2} \times 2\frac{1}{2}$	898	6	Cluny, . . .	$6 \times 2$	899	35
Auvergne, . . .	$7 \times 2\frac{3}{4}$	"	12	Cluny, . . .	$7\frac{3}{8} \times 2\frac{1}{2}$	*	*
Beaumont, . . .	$4\frac{3}{4} \times 2\frac{1}{8}$	899	24	Coburg, . . .	$7\frac{1}{2} \times 3\frac{1}{4}$	899	29
Beauvais, . . .	$6\frac{1}{2} \times 2\frac{3}{4}$	898	10	Colonna, . . .	$4\frac{3}{4} \times 2\frac{1}{2}$	899	37
Biarritz, . . .	$7\frac{5}{8} \times 2\frac{1}{2}$	"	16	Como, . . .	$4 \times 1\frac{1}{2}$	*	*
Belfort, . . .	$5\frac{3}{8} \times 2$	899	39	Como, . . .	$4\frac{1}{2} \times 1\frac{7}{8}$	899	30
Bergamo, . . .	$6\frac{3}{4} \times 2\frac{7}{8}$	"	21	Compiègne, . . .	$6\frac{1}{8} \times 2\frac{3}{4}$	"	32
Bonn, . . .	$3\frac{1}{2} \times 1\frac{1}{2}$	*	*	Corinth, . . .	$4 \times 2\frac{5}{8}$	"	22

\* Not illustrated.

Design.	Size in ins.	Page.	Fig.	Design.	Size in ins.	Page.	Fig.
Dedham, . .	5 × 2 $\frac{3}{4}$	900	43	Hondo, . .	4 × 1 $\frac{1}{2}$	901	64
Deerfield, . .	4 $\frac{7}{8}$ × 2 $\frac{5}{8}$	*	*	Hondo, . .	6 × 2 $\frac{1}{4}$	*	*
Dodona, . .	7 $\frac{1}{8}$ × 2 $\frac{5}{8}$	899	23	Ionian, . .	5 × 2 $\frac{1}{2}$	901	63
Dorchester, . .	4 $\frac{3}{4}$ × 2 $\frac{5}{8}$	900	41	Ituno, . .	2 $\frac{3}{4}$ × 1 $\frac{1}{2}$	"	72
Dorian, . .	4 $\frac{3}{4}$ × 2 $\frac{1}{4}$	899	31	Ituno, . .	4 $\frac{7}{8}$ × 1 $\frac{3}{4}$	*	*
Dormans, . .	5 × 2 $\frac{1}{4}$	"	28	Jamestown, . .	6 $\frac{1}{8}$ × 2 $\frac{1}{2}$	901	68
Dresden, . .	7 $\frac{3}{4}$ × 3 $\frac{1}{2}$	900	42	Jena, . .	5 × 3	"	66
Dreux, . .	6 × 2 $\frac{1}{8}$	594c	33	Jennico, . .	2 $\frac{1}{2}$ × 1 $\frac{1}{2}$	*	*
Duro, . .	4 × 1 $\frac{1}{2}$	"	45	Jennico, . .	3 $\frac{1}{2}$ × 2	901	78
Ebro, . .	4 $\frac{1}{8}$ × 1 $\frac{5}{8}$	"	49	Kelp, . .	6 $\frac{3}{8}$ × 2 $\frac{3}{4}$	"	65
Ephesus, . .	6 × 2 $\frac{3}{4}$	"	50	Largo, . .	5 $\frac{3}{4}$ × 2 $\frac{1}{2}$	"	73
Etrurian, . .	3 × 1 $\frac{1}{2}$	"	47	Larissa, . .	4 $\frac{3}{4}$ × 2 $\frac{1}{2}$	"	70
Fairfax, . .	4 $\frac{1}{2}$ × 2	"	53	Lodi, . .	7 $\frac{1}{4}$ × 2 $\frac{3}{4}$	"	75
Fermo, . .	4 × 1 $\frac{1}{2}$	"	55	Lynn, . .	4 $\frac{1}{4}$ × 2 $\frac{5}{8}$	"	74
Ferrara, . .	4 $\frac{3}{8}$ × 2 $\frac{3}{4}$	"	57	Lyons, . .	5 $\frac{1}{2}$ × 2 $\frac{1}{2}$	"	76
Firenze, . .	8 $\frac{1}{8}$ × 2 $\frac{7}{8}$	"	40	Manchester, . .	7 $\frac{1}{4}$ × 2 $\frac{1}{2}$	902	82
Fleury, . .	5 $\frac{7}{8}$ × 2 $\frac{1}{4}$	"	54	Mandalay, . .	6 $\frac{3}{4}$ × 2	901	67
Florensac, . .	6 $\frac{1}{4}$ × 2 $\frac{3}{4}$	"	51	Marathon, . .	4 $\frac{3}{8}$ × 2 $\frac{1}{2}$	902	89
Florentine, . .	7 × 2	"	44	Marengo, . .	7 $\frac{3}{8}$ × 2 $\frac{1}{4}$	901	71
Florian, . .	2 $\frac{1}{2}$ × 1 $\frac{1}{4}$	"	46	Marguax, . .	6 × 2 $\frac{1}{2}$	"	79
Fontenoy, . .	6 $\frac{1}{8}$ × 3 $\frac{1}{4}$	"	52	Marly, . .	5 $\frac{3}{8}$ × 3 $\frac{1}{8}$	902	81
Gardo, . .	4 × 1 $\frac{1}{2}$	"	56	Meaux, . .	3 $\frac{3}{8}$ × 1 $\frac{7}{8}$	"	88
Gardo, . .	5 $\frac{3}{4}$ × 2 $\frac{1}{4}$	*	*	Medford, . .	4 $\frac{1}{2}$ × 2 $\frac{1}{4}$	"	86
Genoa, . .	5 × 2 $\frac{1}{2}$	900	58	Medici, . .	8 $\frac{1}{4}$ × 2 $\frac{7}{8}$	"	94
Gordian, . .	3 × 1 $\frac{1}{2}$	"	48	Menin, . .	6 $\frac{1}{8}$ × 3 $\frac{1}{4}$	901	77
Grenoble, . .	5 $\frac{1}{4}$ × 2 $\frac{1}{8}$	"	59	Middlesex, . .	4 $\frac{3}{4}$ × 2 $\frac{1}{2}$	594c	34
Guilford, . .	6 $\frac{3}{4}$ × 2 $\frac{3}{4}$	901	69	Milan, . .	7 × 2 $\frac{1}{2}$	902	80
Hellenian, . .	5 × 2 $\frac{1}{2}$	901	61	Miletus, . .	7 $\frac{1}{2}$ × 2 $\frac{5}{8}$	"	84
Hingham, . .	5 $\frac{1}{2}$ × 2 $\frac{1}{2}$	*	*	Monaco, . .	4 × 1 $\frac{1}{2}$	901	60
Hingham, . .	2 × 2	901	62	Navarro, . .	5 $\frac{1}{2}$ × 2	902	83

\* Not illustrated.

Design.	Size in ins.	Page.	Fig.	Design.	Size in ins.	Page.	Fig.
Aimes, . .	$4\frac{3}{4} \times 2\frac{1}{2}$	902	96	Sparta, . .	$5\frac{1}{4} \times 2\frac{1}{2}$	902	95
Porto, . .	$6 \times 2\frac{1}{2}$	594A	7	Stratford, . .	$2\frac{1}{8} \times 1\frac{3}{4}$	594C	35
Salka, . .	$4\frac{1}{2} \times 2$	902	87	Tiber, . .	$5\frac{1}{2} \times 2\frac{1}{4}$	903	105
Arma, . .	$6\frac{5}{8} \times 2\frac{1}{4}$	"	91	Tosca, . .	$4\frac{3}{4} \times 3$	"	107
Busco, . .	$5\frac{3}{8} \times 2\frac{1}{8}$	594A	5	Touraine, . .	$4\frac{1}{8} \times 2\frac{1}{2}$	"	109
Edmont, . .	$5 \times 2\frac{1}{8}$	594B	19	Tunis, . .	$6\frac{1}{4} \times 2\frac{1}{4}$	*	*
Plymouth, . .	$6\frac{5}{8} \times 2\frac{7}{8}$	902	92	Treviso, . .	$6 \times 3\frac{1}{8}$	899	25
Salmon, . .	$7\frac{1}{8} \times 2\frac{1}{2}$	"	93	Trianon, . .	$4 \times 1\frac{3}{8}$	903	111
Abodes, . .	$4\frac{3}{8} \times 2\frac{1}{4}$	"	85	Trianon, . .	$5\frac{1}{2} \times 2\frac{3}{4}$	*	*
Avoli, . .	$8\frac{1}{4} \times 2\frac{5}{8}$	"	90	Urbino, . .	$6 \times 2$	*	*
Canoke, . .	$4\frac{3}{4} \times 2\frac{1}{2}$	"	98	Urbino, . .	$7\frac{3}{4} \times 2\frac{3}{8}$	903	103
Chokeby, . .	$4\frac{3}{4} \times 2\frac{1}{8}$	"	97	Versailles, . .	$6\frac{1}{8} \times 2\frac{1}{4}$	"	110
Cloud, . .	$8\frac{3}{8} \times 2\frac{1}{4}$	903	100	Versailles, . .	$6\frac{1}{8} \times 2\frac{3}{4}$	*	*
Malo, . .	$3\frac{1}{2} \times 2$	"	106	Wentworth, . .	$6\frac{3}{8} \times 2\frac{1}{2}$	594C	38
Walem, . .	$5 \times 2\frac{1}{2}$	902	99	Wilton, . .	$2\frac{1}{2}$ diam.	*	*
Wanlis, . .	$8\frac{1}{4} \times 3\frac{1}{2}$	903	102	Wilton, . .	$2\frac{3}{4}$ "	594C	36
Wvres, . .	$7\frac{1}{2} \times 3$	903	101	Yorktown, . .	$4\frac{1}{2} \times 2\frac{1}{4}$	594C	37
Wena, . .	$8\frac{3}{4} \times 2\frac{5}{8}$	"	104				

\* Not illustrated.

### Plain Push Buttons.

Buffed Bronze or Brass.\*

Illustrated on page 903.

See note as to method of pricing, page 33.

No.	Size in ins.	Fig.	Each.	No.	Size in ins.	Fig.	Each.
110,	$2\frac{3}{4}$ diam.	113	\$3.00	W3416,	$4 \times 1\frac{3}{4}$	116	\$1.00
113,	$2\frac{1}{2} \times 1\frac{1}{4}$	117	1.10	7415,	$3\frac{1}{4} \times 1\frac{7}{8}$	114	1.65
115,	$3\frac{1}{4} \times 1\frac{7}{8}$	115	1.65	7416,	$5 \times 2\frac{1}{2}$	"	2.25
116,	$4\frac{3}{4} \times 2\frac{1}{2}$	"	2.25				

\*No W3416 also made in Steel. For article on "Metals and Finishes" see page 5 and for Nomenclature of Finishes and Explanation of Finish Symbols see page 609.



### Ornamental Push Buttons.

For information see page 895. Illustrations about  $\frac{1}{8}$  size.

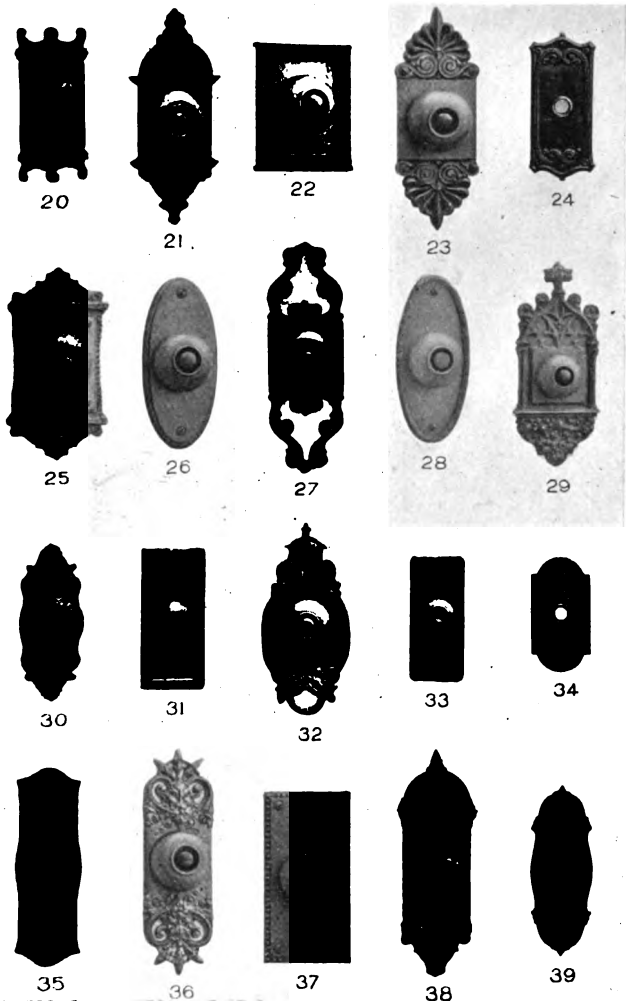

Ornamental Push Buttons.

For information see page 895. Illustrations about 1/8 size.



40



41



42



43



44



45



46



47



48



49



50



51



52



53



54



55



56



57



58



59

### Ornamental Push Buttons.

For information see page 895. Illustrations about  $\frac{1}{4}$  size.



60



61



62



63



64



65



66



67



68



69



70



71



72



73



74



75



76



77



78



79

Ornamental Push Buttons.

For information see page 895. Illustrations about  $\frac{1}{8}$  size





80



81



82



83



84



85



86



87



88



89



90



91



92



93



94



95



96



97



98



99

### Ornamental Push Buttons.

For information see page 895. Illustrations about  $\frac{1}{8}$  size.



100



101



102



103



104



105



106



107



108



109



110



111



112



113



114



115



116



117

Ornamental and Plain Push Buttons.

For information see page 895. Illustrations about 1/8 size.

## Section 13.

### Cup Escutcheons.

Ornamental Cup Escutcheons illustrated on pages 907 to 914. For clue to prices see pages 33 and 244.

Plain Cup Escutcheons illustrated on page 915 and priced on page 906.

For information as to other pieces in these Designs see alphabetical list of all Designs on page 244.

For Designs arranged by Schools see page 236.

Design.	Size in ins.	Page.	Fig.	Design.	Size in ins.	Page.	Fig.
Adams, . .	12 × 3 $\frac{1}{8}$	907	1	Bergamo, . .	10 $\frac{1}{4}$ × 2 $\frac{7}{8}$	908	24
Adria, . .	10 $\frac{1}{2}$ × 3	"	3	Biarritz, . .	11 × 2 $\frac{1}{2}$	"	16
Alcazar, . .	9 $\frac{5}{8}$ × 2 $\frac{1}{2}$	"	7	Bonn, . .	8 × 2 $\frac{3}{4}$	"	29
Alencon, . .	9 $\frac{3}{4}$ × 2 $\frac{1}{2}$	"	4	Bordeaux, . .	14 $\frac{1}{2}$ × 3	"	18
Amboise, . .	9 $\frac{1}{2}$ × 2 $\frac{1}{4}$	"	2	Bothnian, . .	7 $\frac{1}{4}$ × 2 $\frac{1}{4}$	"	19
Amherst, . .	8 $\frac{1}{4}$ × 2 $\frac{1}{2}$	"	11	Brabant, . .	9 $\frac{3}{4}$ × 3 $\frac{1}{2}$	"	20
Amiens, . .	15 $\frac{1}{2}$ × 2 $\frac{1}{2}$	"	10	Breton, . .	9 $\frac{5}{8}$ × 2 $\frac{1}{2}$	594B	29
Anet, . .	10 $\frac{1}{8}$ × 2 $\frac{1}{2}$	"	13	Bristol, . .	6 $\frac{7}{8}$ × 2 $\frac{1}{2}$	908	17
Arcadian, . .	7 $\frac{1}{4}$ × 2 $\frac{1}{4}$	"	5	Brunswick, . .	8 $\frac{1}{4}$ × 2 $\frac{1}{2}$	"	27
Arcola, . .	8 $\frac{1}{2}$ × 3 $\frac{3}{8}$	"	14	Burlington, . .	5 × 1 $\frac{5}{8}$	*	*
Argos, . .	8 × 3	"	15	"	5 $\frac{1}{4}$ × 2 $\frac{1}{4}$	908	23
Arlington, . .	7 $\frac{1}{4}$ × 2 $\frac{1}{2}$	"	8	Castilian, . .	7 $\frac{1}{4}$ × 2 $\frac{1}{4}$	909	39
Arno, . .	8 $\frac{1}{2}$ × 2 $\frac{1}{4}$	"	9	Chambord, . .	9 $\frac{7}{8}$ × 2 $\frac{3}{4}$	"	32
Athens, . .	7 $\frac{1}{4}$ × 2 $\frac{3}{4}$	*	*	Chantilly, . .	11 × 2 $\frac{1}{2}$	"	36
Austerlitz, . .	9 $\frac{1}{4}$ × 2 $\frac{1}{8}$	"	6	Chatillon, . .	9 $\frac{3}{4}$ × 3 $\frac{1}{8}$	"	35
"	10 $\frac{3}{4}$ × 2 $\frac{1}{2}$	*	*	Chester, . .	6 $\frac{3}{4}$ × 2 $\frac{5}{8}$	908	21
Auvergne, . .	8 $\frac{1}{2}$ × 2 $\frac{3}{4}$	907	12	Cluny, . .	8 $\frac{1}{2}$ × 2 $\frac{7}{8}$	909	37
Beaumont, . .	10 $\frac{3}{8}$ × 3 $\frac{3}{8}$	908	28	Coburg, . .	10 $\frac{3}{8}$ × 3 $\frac{1}{4}$	909	31
Beauvais, . .	10 $\frac{3}{8}$ × 2 $\frac{3}{4}$	"	22	Colonna, . .	7 × 2 $\frac{1}{2}$	908	30
Belfort, . .	9 × 2 $\frac{3}{8}$	908	25	Como, . .	7 $\frac{5}{8}$ × 2 $\frac{3}{8}$	909	33

\* Not illustrated.

Design	Size in ins.	Page.	Fig.	Design.	Size in ins.	Page.	Fig.
Compiègne, .	$9\frac{3}{8} \times 2\frac{1}{4}$	909	34	Heidelberg, .	$11\frac{1}{4} \times 3$	911	72
Cordova, .	$10\frac{5}{8} \times 2\frac{1}{4}$	"	38	Hellenian, .	$7 \times 2\frac{1}{2}$	"	63
Corinth, .	$6\frac{3}{4} \times 2\frac{5}{8}$	908	26	Hingham, .	$6 \times 2\frac{1}{2}$	"	71
Dedham, .	$8 \times 4$	910	53	" . .	$8 \times 3$	*	*
Dodona, .	$10\frac{1}{2} \times 2\frac{5}{8}$	909	42	Hondo, . .	$7\frac{1}{2} \times 2\frac{1}{4}$	"	64
Dorchester, .	$7 \times 2\frac{1}{2}$	"	45	Ionian, . .	$7 \times 2\frac{1}{2}$	"	73
Dorian, . .	$7\frac{1}{4} \times 2\frac{1}{4}$	"	41	Ituno, . .	$7\frac{1}{2} \times 2\frac{1}{2}$	"	67
Dormans, .	$6\frac{3}{4} \times 2\frac{1}{2}$	"	40	Jamestown, .	$8\frac{3}{4} \times 3\frac{1}{4}$	"	74
Dreux, . .	$9\frac{3}{8} \times 2\frac{1}{2}$	"	44	Jennico, .	$7 \times 2\frac{1}{2}$	"	69
Dresden, .	$10\frac{5}{8} \times 3\frac{1}{4}$	910	47	Kelp, . .	$8 \times 3\frac{1}{4}$	"	66
Duro, . .	$7 \times 2\frac{3}{4}$	909	43	Largo, . .	$7\frac{5}{8} \times 2\frac{5}{8}$	912	77
Ebro, . .	$8 \times 2\frac{1}{2}$	910	49	Larissa, . .	$6\frac{1}{4} \times 2\frac{5}{8}$	911	75
Ephesus, .	$9\frac{3}{4} \times 2\frac{3}{4}$	"	50	Laval, . .	$9\frac{3}{8} \times 3$	569	1
Etrurian, .	$6\frac{1}{2} \times 2$	"	46	Lodi, . .	$11\frac{5}{8} \times 2\frac{7}{8}$	911	68
Fairfax, . .	$6\frac{5}{8} \times 2\frac{1}{2}$	*	*	Lynn, . .	$6\frac{5}{8} \times 2$	912	76
" . .	$8 \times 3$	910	48	" . .	$7\frac{3}{8} \times 2\frac{1}{2}$	*	*
Fermo, . .	$7\frac{1}{2} \times 2\frac{7}{8}$	"	51	Lyons, . .	$6 \times 2\frac{3}{8}$	911	70
Ferrara, . .	$9\frac{3}{4} \times 3\frac{1}{4}$	*	*	" . .	$8 \times 2\frac{7}{8}$	*	*
" . .	$9\frac{1}{2} \times 3\frac{1}{2}$	910	56	Madras, . .	$6 \times 2\frac{1}{2}$	*	*
Firenze, .	$11\frac{1}{4} \times 3$	"	52	Manchester, .	$13\frac{1}{8} \times 3\frac{1}{8}$	912	86
Fleury, . .	$10 \times 2\frac{3}{4}$	"	60	Mandalay, .	$9 \times 2\frac{1}{2}$	"	79
Florentine, .	$9 \times 2\frac{1}{2}$	"	54	Marathon, .	$7 \times 2\frac{1}{2}$	"	87
Florian, . .	$4\frac{1}{4} \times 2\frac{1}{4}$	"	58	Marengo, .	$9\frac{3}{8} \times 2\frac{1}{4}$	*	*
Fontenoy, .	$9\frac{1}{4} \times 2\frac{1}{8}$	*	*	" . .	$10\frac{5}{8} \times 2\frac{1}{2}$	912	82
" . .	$9\frac{3}{8} \times 2\frac{7}{8}$	910	55	Margaux, .	$8\frac{7}{8} \times 2\frac{1}{2}$	"	81
Gardo, . .	$8 \times 2\frac{1}{4}$	"	59	Marivaux, .	$11\frac{3}{8} \times 2\frac{7}{8}$	594B	16
Genoa, . .	$5\frac{1}{4} \times 2$	911	61	Meaux, . .	$9\frac{3}{4} \times 3\frac{7}{8}$	912	88
" . .	$6\frac{1}{2} \times 2\frac{1}{2}$	*	*	Medford, .	$8 \times 3$	"	85
Gordian, .	$8 \times 2\frac{1}{4}$	910	57	Medici, . .	$11\frac{1}{4} \times 3$	914	120
Grenoble, .	$8\frac{3}{4} \times 2\frac{1}{4}$	911	62	Menin, . .	$10\frac{1}{8} \times 3\frac{1}{8}$	912	78
Guilford, .	$6\frac{5}{8} \times 2\frac{3}{4}$	"	65	Middlesex, .	$8\frac{5}{8} \times 2\frac{1}{2}$	913	92

\* Not illustrated.

Design.	Size in ins.	Page.	Fig.	Design.	Size in ins.	Page.	Fig.
Milan, . . .	12 X 2½	912	90	Saarbruck, . . .	11¾ X 3¾	913	105
Miletus, . . .	13¼ X 3	"	84	Salem, . . .	9 X 2½	"	103
Monaco, . . .	8½ X 2½	"	80	Sparta, . . .	7½ X 2	*	*
Murano, . . .	6⅝ X 2⅝	914	112	" . . .	8 X 2¾	913	104
Navarro, . . .	8½ X 2¾	913	91	" . . .	10¼ X 2¾	"	*
Nantucket, . . .	3 dia.	"	*	St. Cloud, . . .	10 X 2¾	914	107
Nimes, . . .	8 X 3	913	94	St. Malo, . . .	5½ X 3¾	"	113
Oporto, . . .	8⅝ X 2½	594B	26	Stratford, . . .	9 X 3¾	"	111
Oriental, . . .	4¾ X 2	913	98	Tiber, . . .	8¾ X 2½	"	109
Osaka, . . .	8¼ X 2¾	"	95	Tosca, . . .	10½ X 3	"	108
Palermo, . . .	10 X 2⅝	"	100	Touraine, . . .	6⅞ X 2⅞	912	89
Parma, . . .	9⅞ X 2¼	"	96	Treviso, . . .	11½ X 3	914	110
Pasco, . . .	8¾ X 2¾	594B	28	Trianon, . . .	8½ X 2¾	"	117
Piedmont, . . .	7¼ X 2½	"	25	Tunis, . . .	8¼ X 2¾	"	119
Plain, . . .	. . . . .	915	121	Urbino, . . .	8 X 2¾	"	*
Plymouth, . . .	8 X 2¾	913	97	" . . .	10 X 2¾	914	116
Raleigh, . . .	8¾ X 2⅝	594B	27	Vergennes, . . .	9 X 3¾	"	106
Realmont, . . .	9 X 3¾	913	93	Versailles, . . .	10⅝ X 2¾	"	118
Rhodes, . . .	8¾ X 3	"	99	Weymouth, . . .	6⅞ X 2⅝	"	114
Roanoke, . . .	8 X 3	"	101	Woburn, . . .	5⅞ X 2¼	912	83
Rokeby, . . .	7⅞ X 2⅝	"	102	Yorktown, . . .	7½ X 2¼	914	115

\* Not illustrated.

## Plain Cup Escutcheons.

Buffed Bronze or Brass.\*

Illustrated on page 915; see also Part V, pages 706 and 707.

CAST METAL.				CAST METAL.			
No.	Size in ins.	Fig.	Pair.	No.	Size in ins.	Fig.	Pair.
19	3½ X 1⅞	132	\$2.65	6854	8 X 3	125	\$5.80
19¼	"	133	2.65	70854	"	135	5.80
827	3½ X 3½	129	8.80	810	10 X 3½	131	11.90
850	6 X 2½	122	3.20	WROUGHT METAL.			
6850	"	123	3.20	W8¼	4 X 2⅝	128	.90
70850	"	130	3.20	W5850	4¼ X 2¼	121	1.00
854	8 X 3	124	5.80	W7850	6 X 2	127	1.10
855	"	134	10.00	W7854	7¼ X 2¼	126	1.60

\* Nos. W8¼, W5850, W7850 and W7854 also made in Steel. For article on "Metals and Finishes" see page 595, and for Nomenclature of Finishes and Explanation of Finish Symbols see page 609.

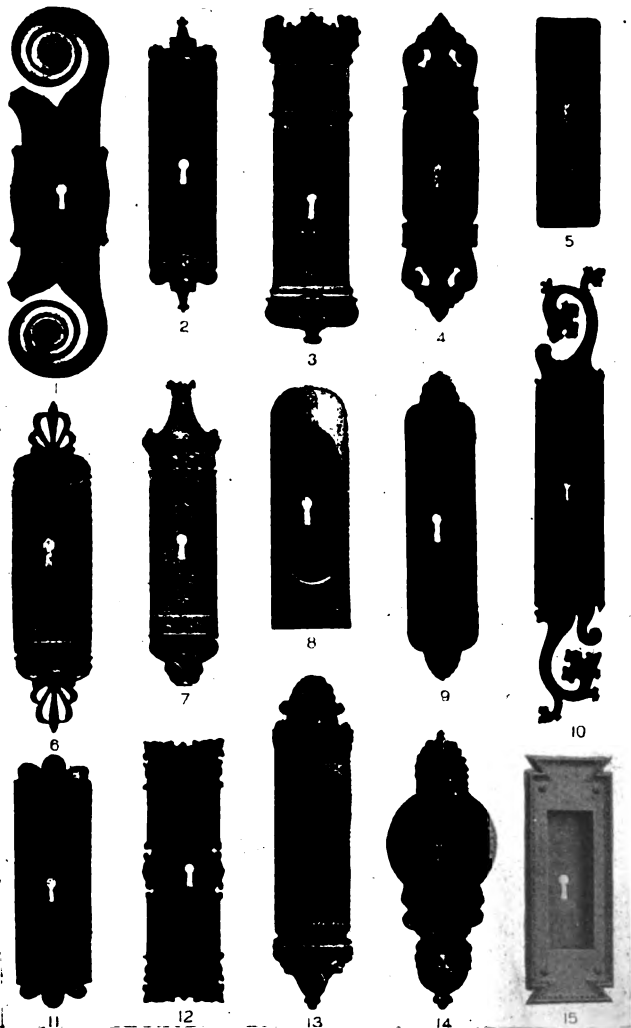

Ornamental Cup Escutcheons.

For information see page 904. Illustrations about one-sixth size.



16



17



18



19



20



22



23



24



25



21



28



26



27



29



30

### Ornamental Cup Escutcheons.

For information see page 904. Illustrations about one-sixth size.

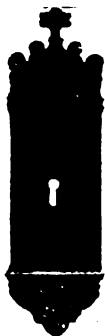

31



32



33



34



35



36



37



38



39



40



41



42



43



44



45

Ornamental Cup Escutcheons.

For information see page 904. Illustrations about one-sixth size.





46



47



48



49



50



51



52



53



54



55



56



57



58



59



60

Ornamental Cup Escutcheons.

For information see page 904. by Illustrations about one-sixth size.



61



62



63



64



65



66



67



68



69



70



71



72



73



74



75

Ornamental Cup Escutcheons.

For information see page 904. Illustrations about one-sixth size.



106



107



108



109



110



111



112



113



114



115



116



117



118



119

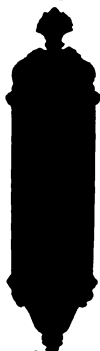

120

### Ornamental Cup Escutcheons.

For information see page 904. Illustrations about one-sixth size.



121



122



123



124



125



126



127



128



129



130



131



132



133



134



135

Plain Cup Escutcheons.

For sizes and prices see page 906. Illustrations about one-sixth size.

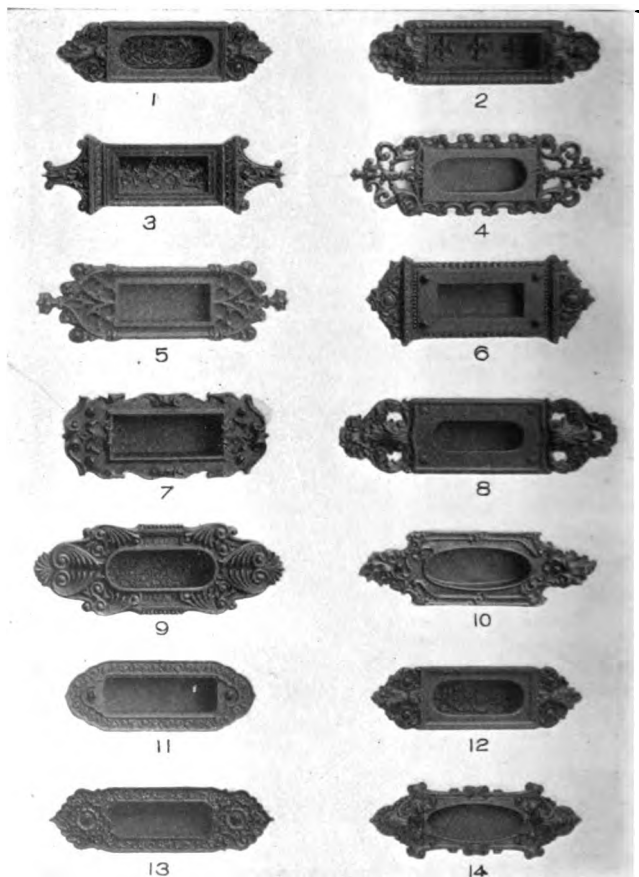

### Ornamental Flush Sash Lifts.

The examples shown above are intended only to illustrate the method of applying ornament to Flush Sash Lifts.

For appearance of Flush Sash Lifts not here shown see Cup Escutcheons illustrated in pages 907 to 915.

In Part III will be found Flush Sash Lifts listed under various Designs.



1



3



2



4



5



7



6



8



9



11



10



12



13



14

Ornamental Letter Drops and Hoods.

The examples shown above are intended on'y to illustrate the method of applying ornament to Letter Drops and Hoods. Figs. 3 and 4 are Special.

In Part III will be found Letter Drops and Hoods listed under various Designs.



1



2



3



4



5



6



7



8



9



10



11

### Ornamental Butt Tips.

The examples shown above should be specified by the number under each. The Tips may be used with Loose Pin Butts Nos. 750 and 780 in sizes as required.

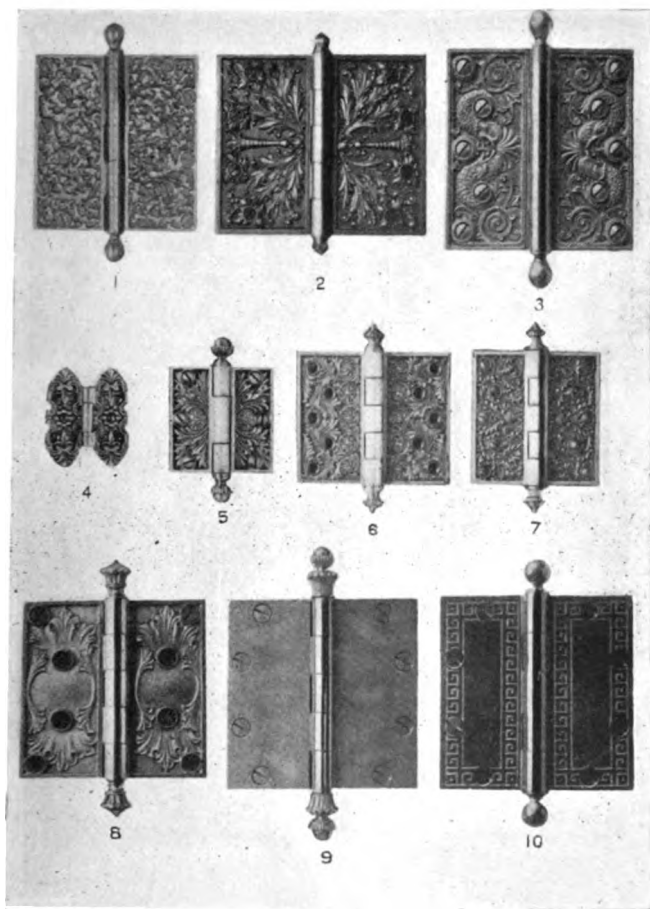

### Ornamental Butts.

The examples shown above are intended only to illustrate the method of applying ornament to Butts.

In Part III will be found Butts listed under various Designs.



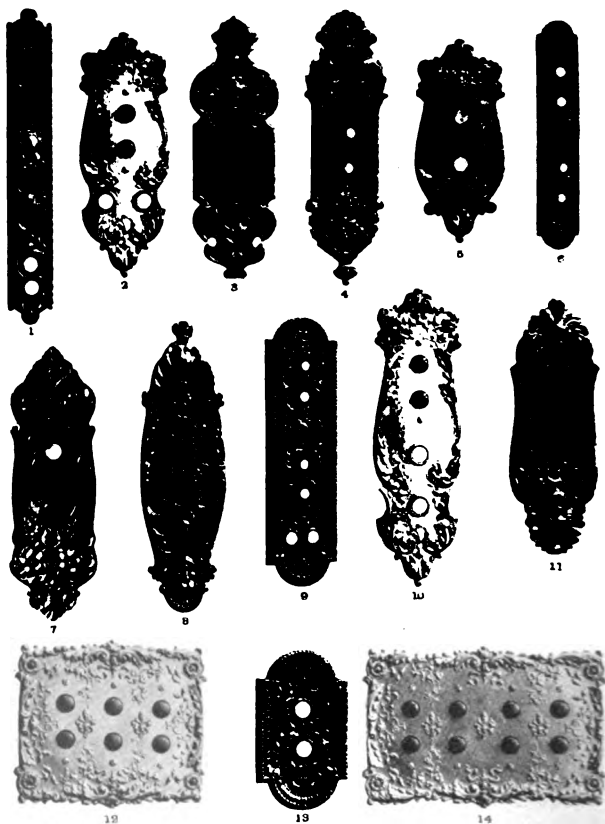

### Ornamental Switch Plates.

The examples shown above are intended only to illustrate the method of applying ornament to Switch Plates.

The number and spacing of Buttons differ in nearly every case, but in most of the Designs shown in Part III will be found plates suitable for making up as Switch Plates.



Ornamental Coat and Hat Hooks.

The examples shown above should be specified by figure number.  
For Plain Coat and Hat Hooks see pages 794 and 795.



### Ornamental Shutter Trim.

The examples shown above are intended only to illustrate the method of applying ornament to Shutter Trim. In Part III will be found Shutter Trim listed under various Designs. For Plain Shutter Trim see pages 772, 773, 796 and 812.



1

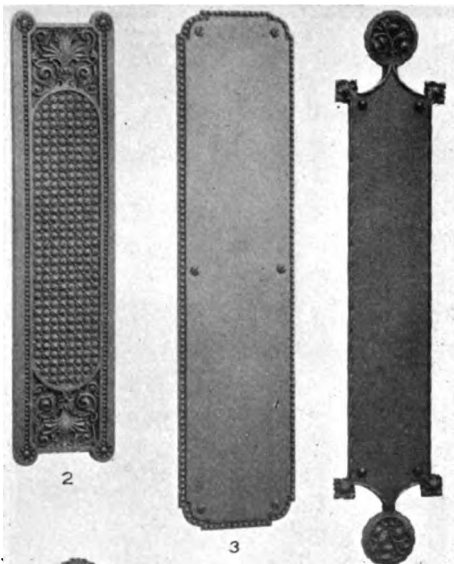

2

3

4



5



6



7



8

Ornamental Push Plates.

The examples shown above are intended only to illustrate the method of applying ornament to Push Plates. In Part III will be found Push Plates listed under various Designs. For Plain Push Plates see pages 802 and 803.

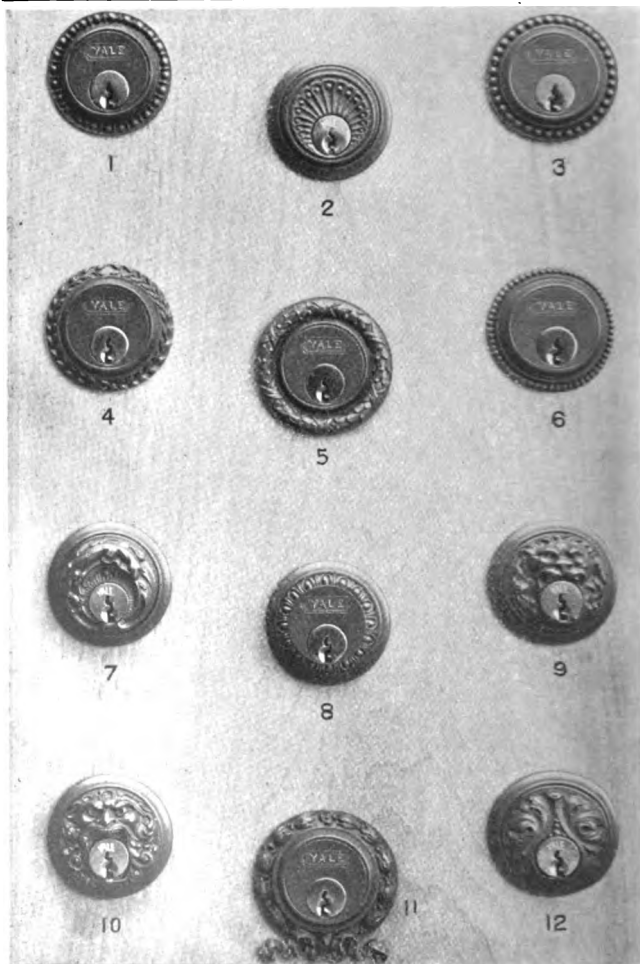

### Ornamental Cylinders and Rings.

1, Tosca; 2, Ferrara; 3, Colonna; 4, Trianon; 5, Adria; 6, Bristol; 7, Antwerp;  
8, Corinth; 9, Firenze; 10, Certosa; 11, Jena; and 12, Chatillon.

In Part III will be found Cylinders and Rings listed under various Designs.

## Section 23.

### Drawer Pulls.

**Ornamental Drawer Pulls** illustrated on pages 927 to 937D. For clue to prices see pages 33 and 244.

**Plain Drawer Pulls** illustrated and priced on pages 938 and 939.

For information as to other pieces in these Designs see alphabetical list of all Designs, page 244.

For Designs arranged by Schools see page 236.

Design.	Size in ins.	Page.	Fig.	Design.	Size in ins.	Page.	Fig.
Adams, . . .	$1\frac{7}{8} \times 6$	594B	18	Aumont, . . .	$1\frac{3}{4} \times 5\frac{1}{8}$	*	*
Alcazar, . . .	$6 \times 2$	937c	97	“ . . .	$2 \times 8\frac{1}{8}$	974	4
Alencon, . . .	$2\frac{1}{4} \times 7\frac{7}{8}$	594B	24	Austerlitz, . . .	$1\frac{3}{8} \times 5\frac{1}{4}$	*	*
Amboise, . . .	$2 \times 6\frac{1}{4}$	594c	39	“ . . .	$1\frac{1}{4} \times 6$	932	28
Amherst, . . .	$2 \times 3\frac{1}{4}$	937	71	Auvergne, . . .	$1\frac{7}{8} \times 6\frac{1}{4}$	594c	42
“ . . .	$1\frac{1}{8} \times 3$	*	*	Beauvais, . . .	$1\frac{5}{8} \times 5\frac{1}{4}$	594D	43
“ . . .	$1\frac{1}{8} \times 5\frac{7}{8}$	933	36	Beauvoir, . . .	$1\frac{3}{4} \times 3\frac{5}{8}$	977	3
Anet, . . .	$\frac{7}{8} \times 4\frac{1}{4}$	*	*	Belfort, . . .	$1\frac{1}{2} \times 5$	594D	44
“ . . .	$1 \times 4\frac{5}{8}$	930	13	Beverly, . . .	$4 \times 2\frac{7}{8}$	976	4
Angouleme, . . .	$1 \times \frac{3}{4}$	937A	86	“ . . .	$10 \times 3\frac{1}{2}$	“	3
“ . . .	$1\frac{3}{8} \times 4\frac{7}{8}$	976	3	“ . . .	$3\frac{1}{4} \times 3\frac{7}{8}$	“	1
Annapolis, . . .	$1\frac{1}{8} \times 2\frac{5}{8}$	*	*	Bonn, . . .	$1\frac{1}{2} \times 3\frac{1}{2}$	*	*
“ . . .	$1\frac{3}{8} \times 3\frac{1}{4}$	937	68	“ . . .	$1\frac{1}{2} \times 3\frac{7}{8}$	929	2
“ . . .	$1\frac{3}{8} \times 3\frac{1}{2}$	“	70	Bourg, . . .	$2 \times 6\frac{1}{4}$	932	32
“ . . .	$1\frac{1}{2} \times 4\frac{1}{8}$	“	72	Brabant, . . .	$2 \times 5\frac{1}{8}$	594D	45
Arcadian, . . .	$1\frac{1}{2} \times 4$	594c	40	Bristol, . . .	$\frac{7}{8} \times 3\frac{1}{8}$	936	58
Argos, . . .	$1\frac{1}{4} \times 4\frac{1}{2}$	937c	101	“ . . .	$\frac{7}{8} \times 4$	*	*
Arno, . . .	$1\frac{3}{8} \times 5$	594c	41	“ . . .	$\frac{7}{8}$ diam.	937A	84
Athens, . . .	$1\frac{1}{4} \times 4\frac{1}{2}$	937c	98	“ . . .	$1\frac{3}{4} \times 4\frac{1}{2}$	933	33

\*Not illustrated.

Design.	Size in ins.	Page.	Fig.	Design.	Size in ins.	Page.	Fig.
Brockton, .	$1\frac{7}{8} \times 3\frac{3}{8}$	935	51	Dedham, .	$2\frac{1}{8} \times 4\frac{1}{4}$	594D	50
" .	$2\frac{7}{8} \times 3\frac{5}{8}$	"	49	" . .	$1\frac{3}{4} \times 3\frac{3}{4}$	"	"
" .	$2\frac{7}{8} \times 4\frac{1}{8}$	"	53	Dodona, .	$1\frac{5}{8} \times 6$	594D	51
" .	$3\frac{1}{8} \times 5$	"	55	Dormans, .	$1\frac{7}{8} \times 4\frac{1}{4}$	929	8
" .	$3\frac{1}{4} \times 4\frac{3}{4}$	"	52	Elne, . .	$1\frac{1}{2}$ diam.	937B	93
" .	$3\frac{3}{8} \times 4\frac{5}{8}$	"	54	Epernay, .	$1\frac{3}{8} \times 5\frac{1}{8}$	978	3
Caen, . .	$3\frac{1}{2} \times 7$	979	3	Ephesus, .	$1\frac{3}{4} \times 5\frac{7}{8}$	930	11
" . .	$4\frac{1}{8} \times 6\frac{3}{4}$	"	"	Epinal, . .	$2\frac{1}{4} \times 5$	936	63
Cambridge, .	$1\frac{1}{4} \times 1\frac{1}{2}$	937A	81	Exeter, . .	$1\frac{3}{8} \times 5\frac{3}{8}$	937	75
" .	$1\frac{5}{8}$ diam.	"	79	Fairfax, . .	$1\frac{3}{8} \times 3\frac{1}{4}$	"	73
" .	$1\frac{5}{8}$ diam.	"	76	" . .	$1 \times 4\frac{7}{8}$	933	34
" .	$2\frac{3}{8}$ diam.	"	77	Ferrara, . .	$2\frac{1}{2}$ diam.	982	11
Carrara, . .	$1\frac{5}{8} \times 4$	930	16	" . .	$1 \times 2\frac{3}{4}$	"	9
Chatillon, .	$1\frac{7}{8} \times 5\frac{1}{4}$	594D	46	" . .	$1\frac{1}{8} \times 3$	"	3
Chester, . .	$1\frac{5}{8} \times 4\frac{3}{8}$	"	47	" . .	$1\frac{5}{8} \times 4$	"	6
Clermont, . .	$1\frac{5}{8} \times 3\frac{1}{2}$	"	"	" . .	$2\frac{1}{8} \times 6\frac{1}{2}$	"	1
" .	$1\frac{3}{8} \times 4\frac{1}{4}$	979	2	" . .	$3\frac{1}{2} \times 10\frac{1}{2}$	"	"
" .	$1\frac{1}{4} \times 4\frac{1}{4}$	"	"	Firenze, . .	$1\frac{1}{2} \times 5\frac{1}{2}$	930	12
Cluny, . .	$1\frac{1}{2} \times 5\frac{1}{8}$	931	18	Fleury, . .	$1\frac{3}{4} \times 5\frac{5}{8}$	929	6
" . .	$2 \times 6$	"	20	Florian, . .	$\frac{7}{8} \times 4\frac{1}{4}$	"	"
" . .	$2 \times 6\frac{1}{4}$	"	"	" . .	$\frac{7}{8} \times 3\frac{3}{4}$	"	"
Colonna, . .	$1\frac{5}{8} \times 3\frac{7}{8}$	594D	48	" . .	$\frac{7}{8} \times 3\frac{1}{4}$	"	"
Como, . .	$1\frac{5}{8} \times 4\frac{7}{8}$	"	49	" . .	$2 \times 3\frac{3}{4}$	"	"
Concord, . .	$1\frac{7}{8} \times 5\frac{3}{4}$	977	1	" . .	$2\frac{1}{4} \times 4\frac{1}{8}$	"	"
Conde, . .	$2 \times 5\frac{1}{4}$	936	64	" . .	$1\frac{1}{2} \times 3\frac{1}{2}$	937C	102
Corinth, . .	$1\frac{5}{8} \times 3\frac{1}{2}$	930	9	Fontenoy, .	$1\frac{1}{2} \times 5\frac{1}{2}$	937B	87
" . .	$1\frac{5}{8} \times 4\frac{1}{2}$	"	"	" . .	$3\frac{1}{2} \times 5\frac{1}{2}$	"	94
Dax, . .	$2\frac{7}{8} \times 1\frac{3}{8}$	"	"	" . .	$1\frac{1}{2} \times 4\frac{1}{2}$	"	91
" . .	$1\frac{5}{8} \times 3\frac{3}{4}$	978	3	" . .	$1\frac{3}{4} \times 4\frac{3}{4}$	929	4
Derby, . .	$2 \times 4\frac{1}{8}$	937C	103	Fronsac, . .	$2 \times 1$	937B	88

\*Not illustrated.

Design.	Size in ins.	Page.	Fig.	Design.	Size in ins.	Page.	Fig.
Fronsac, . . .	2 × 1	937B	90	Lexington, . . .	1 3/8 × 2 1/4	936	66
" . . .	2 5/8 × 1 3/8	"	89	Lodi, . . .	1 × 5 1/4	930	10
Gardo, . . .	1 5/8 × 5	594D	52	Lowell, . . .	1 1/8 × 3 5/8	936	60
Genoa, . . .	1 1/2 × 3 1/2	*	*	" . . .	1 1/8 × 1 1/8	937A	85
" . . .	1 7/8 × 5 1/8	594D	53	Lynn, . . .	1 × 4 1/8	931	17
Grenoble, . . .	1 1/8 × 5 1/8	"	54	" . . .	1 1/8 × 4 1/4	"	19
Hartford, . . .	2 3/8 × 5 3/4	935	50	" . . .	1 1/2 × 3 1/2	*	*
Heidelberg, . . .	2 × 6 7/8	930	15	" . . .	1 1/2 × 4	*	*
Hingham, . . .	1 1/2 × 3 1/2	937	69	" . . .	1 1/2 × 5 1/2	*	*
" . . .	1 3/4 × 3 3/8	984	5	Lyons, . . .	1 7/8 × 4 1/4	594D	58
" . . .	1 × 4 5/8	933	38	" . . .	1 7/8 × 4 3/8	*	*
" . . .	1 3/4 × 4 1/2	"	40	Madras, . . .	7/8 × 2 3/4	594D	59
Hellenian, . . .	1 3/4 × 4 1/2	937C	99	Manchester, . . .	1 7/8 × 3 5/8	937A	78
Hondo, . . .	1 1/2 × 5	594D	55	" . . .	2 × 6 3/8	*	*
Ionian, . . .	1 3/4 × 4 1/2	937C	100	Marathon, . . .	1 5/8 × 4	937D	105
Ituno, . . .	1 3/4 × 4 7/8	594D	56	Marly, . . .	2 × 4 7/8	594D	60
Ivry, . . .	2 1/4 × 5 3/4	985	3	Meaux, . . .	1 7/8 × 4 5/8	"	61
Jamestown, . . .	1 × 5	934	41	Medford, . . .	2 × 4 3/4	"	62
Jarnac, . . .	1 5/8 × 3 7/8	980	5	Medici, . . .	1 1/2 × 5 1/2	930	12
Jennico, . . .	1 5/8 × 3 7/8	594D	57	Milan, . . .	1 7/8 × 6	929	5
" . . .	1 1/2 × 3 3/4	*	*	Monaco, . . .	1 1/2 × 5	594D	63
Kelp, . . .	1 1/4 × 2 5/8	*	*	Montauban, . . .	1 3/4 × 4	981	3
" . . .	1 3/4 × 3 3/4	937	67	Navarro, . . .	1 3/4 × 5 3/8	937D	109
" . . .	1 3/4 × 4 1/4	*	*	Nimes, . . .	1 5/8 × 4 1/2	932	26
" . . .	1 5/8 × 4 3/8	931	22	Oporto, . . .	1 7/8 × 5 1/4	937D	111
" . . .	2 × 4 7/8	*	*	Oriental, . . .	7/8 × 4 1/4	594D	64
Lagrasse, . . .	1 7/8 × 3 3/4	981	3	" . . .	7/8 × 3 3/4	*	*
Largo, . . .	2 × 5 1/4	937C	104	" . . .	7/8 × 3 1/4	*	*
Larissa, . . .	1 × 4 5/8	932	27	Osaka, . . .	1 3/4 × 4 3/4	937D	107
" . . .	1 1/4 × 4 3/4	*	*	Palermo, . . .	1 7/8 × 6 1/8	929	7

\*Not illustrated.



Design.	Size in ins.	Page.	Fig.	Design.	Size in ins.	Page.	Fig.
Pasco, . . .	$1\frac{3}{8} \times 4\frac{7}{8}$	937D	106	St. Cloud, . .	$1\frac{1}{2} \times 5$	937A	80
Petersham, .	$1\frac{1}{8} \times 4\frac{1}{2}$	936	61	Stratford, . .	$1\frac{3}{8} \times 4\frac{7}{8}$	929	1
Piedmont, . .	$1\frac{5}{8} \times 4\frac{1}{4}$	937D	108	" . . .	$1 \times 4$	*	*
Plain, . . . .		938	$1\frac{1}{2}$ <sup>3</sup> / <sub>8</sub>	Tiber, . . . .	$1\frac{1}{2} \times 4\frac{1}{2}$	937D	112
Plymouth, . .	$1\frac{1}{8} \times 2\frac{1}{2}$	986	3	Toulon, . . .	$2 \times 4\frac{7}{8}$	935	56
" . . . .	$1\frac{5}{8} \times 3\frac{3}{8}$	"	8	Toulouse, . .	$1\frac{1}{2} \times 3\frac{3}{8}$	936	62
" . . . .	$1\frac{5}{8} \times 5\frac{1}{4}$	"	4	" . . . .	$1\frac{1}{2} \times 1\frac{1}{2}$	937B	95
" . . . .	$1\frac{3}{8} \times 3$	"	6	" . . . .	$3\frac{1}{8} \times 3\frac{1}{8}$	937A	83
" . . . .	$1\frac{3}{8} \times 5\frac{3}{4}$	*	*	Tours, . . . .	$1\frac{1}{2} \times 4\frac{7}{8}$	989	3
Portsmouth, .	$1\frac{1}{2} \times 4\frac{1}{2}$	937B	92	Traves, . . .	$1\frac{3}{8} \times 6\frac{1}{4}$	934	42
" . . . .	$1 \times 3\frac{5}{8}$	936	57	Trianon, . . .	$1\frac{1}{4} \times 3$	937B	96
Putnam, . . .	$1\frac{1}{2} \times 4\frac{3}{8}$	"	65	" . . . .	$1\frac{3}{8} \times 4$	932	30
" . . . .	$1\frac{1}{2} \times 5$	932	31	" . . . .	$2 \times 5\frac{1}{8}$	*	*
Realmont, . .	$1\frac{7}{8} \times 5\frac{1}{8}$	594D	65	Tunis, . . . .	$1\frac{1}{4} \times 3\frac{7}{8}$	*	*
Revere, . . .	$1\frac{7}{8} \times 4$	934	45	" . . . .	$1\frac{1}{4} \times 4\frac{3}{8}$	936	59
" . . . .	$1\frac{3}{8} \times 4$	"	43	" . . . .	$1\frac{1}{4}$ diam.	*	*
Rhodes, . . .	$1\frac{3}{8} \times 2\frac{3}{4}$	*	*	" . . . .	$2 \times 5\frac{1}{2}$	929	3
" . . . .	$1\frac{3}{8} \times 3\frac{3}{8}$	594D	66	Urbino, . . .	$1\frac{1}{4} \times 6\frac{3}{8}$	931	21
Roanoke, . . .	$1\frac{5}{8} \times 4\frac{1}{2}$	932	25	" . . . .	$2 \times 6\frac{7}{8}$	"	23
Salem, . . . .	$1\frac{3}{8} \times 4\frac{1}{4}$	937	74	" . . . .	$2 \times 8\frac{7}{8}$	*	*
" . . . .	$1\frac{1}{4} \times 5\frac{1}{2}$	933	37	Valence, . . .	$1\frac{1}{8} \times 3\frac{1}{2}$	*	*
" . . . .	$2 \times 5\frac{1}{2}$	"	39	" . . . .	$1\frac{3}{8} \times 5\frac{7}{8}$	989	3
Savona, . . .	$1 \times 4$	930	14	Warren, . . .	$1 \times 4\frac{1}{8}$	934	44
Sparta, . . .	$1\frac{1}{4}$ diam.	937A	82	" . . . .	$1\frac{1}{2} \times 4\frac{5}{8}$	"	46
" . . . .	$1\frac{5}{8} \times 5\frac{3}{4}$	933	35	Weymouth, .	$1\frac{5}{8} \times 4\frac{3}{8}$	594A	8
St. Cloud, . .	$1\frac{1}{2} \times 5\frac{1}{8}$	988	2	Woburn, . . .	$1 \times 3\frac{7}{8}$	937D	110

\*Not illustrated.



1



2



3



4



5



6

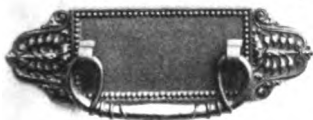

7



8

Drop Drawer Pulls.

Fig.	Design.	Size in ins.	Fig.	Design.	Size in ins.
1,	Stratford,	$1\frac{3}{4} \times 4\frac{7}{8}$	5,	Milan,	$1\frac{7}{8} \times 6$
2,	Bonn.	$1\frac{1}{2} \times 3\frac{7}{8}$	6,	Fleury,	$1\frac{3}{4} \times 5\frac{5}{8}$
3,	Tunis,	$2 \times 5\frac{1}{2}$	7,	Palermo,	$1\frac{7}{8} \times 6\frac{1}{8}$
4,	Fontenoy,	$1\frac{3}{4} \times 4\frac{3}{4}$	8,	Dormans,	$1\frac{7}{8} \times 4\frac{1}{4}$

For further information see page 925.

Illustrations about  $\frac{1}{2}$  size.



9



10



11



12



13



14



15



16

### Drop Drawer Pulls.

Fig.	Design	Size in ins.	Fig.	Design	Size in ins.
9,	Corinth,	$1\frac{5}{8} \times 3\frac{1}{2}$	13,	Anet,	$1 \times 4\frac{3}{8}$
10,	Lodi,	$1 \times 5\frac{1}{4}$	14,	Savona,	$1 \times 4$
11,	Ephesus,	$1\frac{3}{4} \times 5\frac{7}{8}$	15,	Heidelberg,	$2 \times 6\frac{1}{2}$
12,	Firenze,	$1\frac{1}{2} \times 5\frac{1}{2}$	16,	Carrara,	$1\frac{5}{8} \times 4$

For further information see page 925.

Illustrations about  $\frac{1}{4}$  size.



17



18

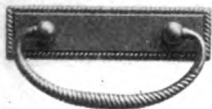

19

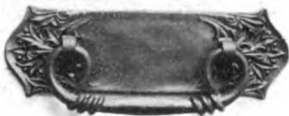

20



21



22



23



24

Drop Drawer Pulls.

Fig.	Design.	Size in ins.	Fig.	Design.	Size in ins.
17,	Lynn, . . . . .	1 × 4 1/8	21,	Urbino, . . . . .	1 1/4 × 6 1/8
18,	Cluny, . . . . .	1 1/2 × 5 1/8	22,	Kelp, . . . . .	1 5/8 × 4 3/8
19,	Lynn, . . . . .	1 1/8 × 4 1/4	23,	Urbino, . . . . .	2 × 6 7/8
20,	Cluny, . . . . .	2 × 6 1/4	24,	Kelp, . . . . .	2 × 4 7/8

For further information see page 925.

Illustrations about 1/4 size.



25



26



27



28



29



30

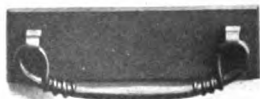

31



32

### Drop Drawer Pulls.

Fig.	Design.	Size in ins.	Fig.	Design.	Size in ins.
25,	Roanoke, . . . .	$1\frac{5}{8} \times 4\frac{1}{2}$	29,	Plain, . . . .	$1 \times 4\frac{1}{4}$
26,	Nimes, . . . .	$1\frac{5}{8} \times 4\frac{1}{2}$	30,	Trianon, . . . .	$1\frac{3}{8} \times 4$
27,	Larissa, . . . .	$1 \times 4\frac{5}{8}$	31,	Putnam, . . . .	$1\frac{1}{2} \times 5$
28,	Austerlitz, . . . .	$1\frac{1}{4} \times 6$	32,	Bourg, . . . .	$2 \times 6\frac{1}{4}$

For further information see page 925.

Illustrations about  $\frac{1}{4}$  size.



33

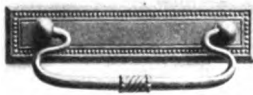

34



35

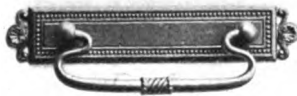

36



37



38



39



40

Drop Drawer Pulls.

Fig.	Design.	Size in ins.	Fig.	Design.	Size in ins.
33,	Bristol,	$1\frac{3}{4} \times 4\frac{1}{2}$	37,	Salem,	$1\frac{1}{4} \times 5\frac{1}{2}$
34,	Fairfax,	$1 \times 4\frac{7}{8}$	38,	Hingham,	$1 \times 4\frac{5}{8}$
35,	Sparta,	$1\frac{5}{8} \times 5\frac{3}{4}$	39,	Salem,	$2 \times 5\frac{1}{2}$
36,	Amherst,	$1\frac{1}{8} \times 5\frac{7}{8}$	40,	Hingham,	$1\frac{3}{4} \times 4\frac{1}{2}$

For further information see page 925.

Illustrations about  $\frac{1}{4}$  size.



41



42



43



44

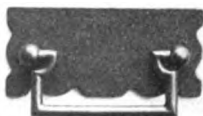

45



46



47



48

### Drop Drawer Pulls.

Fig.	Design.	Size in ins.	Fig.	Design.	Size in ins.
41,	Jamestown,	1 X 5	45,	Revere,	1 7/8 X 4
42,	Traves,	1 3/8 X 6 1/4	46,	Warren,	1 1/2 X 4 5/8
43,	Revere,	1 3/8 X 4	47,	Plain,	1 1/2 X 5 1/4
44,	Warren,	1 X 4 1/8	48,	Plain,	1 1/4 X 4 3/8

For further information see page 925.

Illustrations about 1/2 size.



49



50



51



52



53



54



55



56

Drop Drawer Pulls.

Fig.	Design.	Size in ins.	Fig.	Design.	Size in ins.
49,	Brockton,	$2\frac{7}{8} \times 3\frac{5}{8}$	53,	Brockton,	$2\frac{7}{8} \times 4\frac{1}{8}$
50,	Hartford,	$2\frac{3}{8} \times 5\frac{3}{4}$	54,	Brockton,	$3\frac{3}{8} \times 4\frac{5}{8}$
51,	Brockton,	$1\frac{7}{8} \times 3\frac{3}{8}$	55,	Brockton,	$3\frac{1}{8} \times 5$
52,	Brockton,	$3\frac{1}{4} \times 4\frac{3}{4}$	56,	Toulon,	$2 \times 4\frac{7}{8}$

For further information see page 925.

Illustrations about  $\frac{1}{2}$  size.





57



58



59



60



61



62



63



64



65



66

## Drop Drawer Pulls.

Fig.	Design.	Size in ins.	Fig.	Design.	Size in ins.
57,	Portsmouth,	$1 \times 3\frac{5}{8}$	62,	Toulouse,	$1\frac{1}{2} \times 3\frac{3}{8}$
58,	Bristol,	$\frac{7}{8} \times 3\frac{1}{8}$	63,	Epinal,	$2\frac{1}{4} \times 5$
59,	Tunis,	$1\frac{1}{4} \times 4\frac{3}{8}$	64,	Conde,	$2 \times 5\frac{1}{4}$
60,	Lowell,	$1\frac{1}{8} \times 3\frac{5}{8}$	65,	Putnam,	$1\frac{1}{2} \times 4\frac{3}{8}$
61,	Petersham,	$1\frac{1}{8} \times 4\frac{1}{2}$	66,	Lexington,	$1\frac{3}{8} \times 2\frac{1}{4}$

For further information see page 925.

Illustrations about  $\frac{1}{4}$  size.

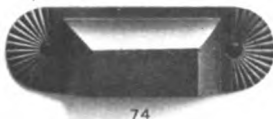
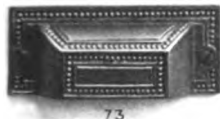

Drawer Pulls.

Fig.	Design.	Size in ins.	Fig.	Design.	Size in ins.
67,	Kelp, . . . . .	$1\frac{3}{4} \times 3\frac{3}{4}$	72,	Annapolis, . . . . .	$1\frac{1}{2} \times 4\frac{1}{8}$
68,	Annapolis, . . . . .	$1\frac{3}{8} \times 3\frac{1}{4}$	73,	Fairfax, . . . . .	$1\frac{3}{8} \times 3\frac{1}{4}$
69,	Hingham, . . . . .	$1\frac{1}{2} \times 3\frac{1}{2}$	74,	Salem, . . . . .	$1\frac{3}{8} \times 4\frac{1}{4}$
70,	Annapolis, . . . . .	$1\frac{3}{8} \times 3\frac{1}{2}$	75,	Exeter, . . . . .	$1\frac{3}{8} \times 5\frac{3}{8}$
71,	Amherst, . . . . .	$2 \times 3\frac{1}{4}$			

For further information see page 925.

Illustrations about  $\frac{1}{4}$  size.

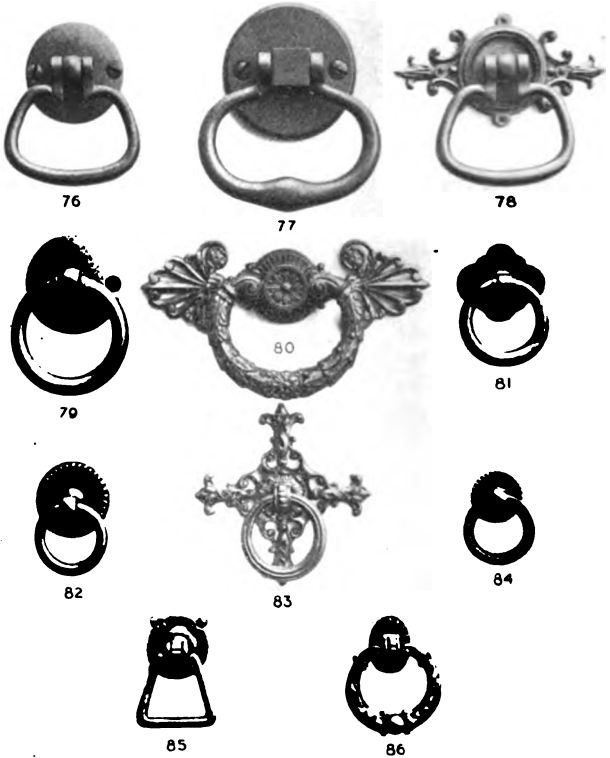

Drop Drawer Pulls.

Fig.	Design	Size in ins.	Fig.	Design	Size in ins.
76,	Cambridge,	1 5/8 dia.	82,	Sparta,	1 1/4 dia.
77,	Cambridge,	2 3/8 "	83,	Toulouse,	3 1/8 x 3 1/8
78,	Manchester,	1 7/8 x 3 5/8	84,	Bristol,	7/8 dia.
79,	Cambridge,	1 5/8 dia.	85,	Lowell,	1 1/8 x 1 1/8
80,	Sr. Cloud,	1 1/2 x 5	86,	Angouleme,	1 x 3/4
81,	Cambridge,	1 1/4 x 1 1/2			

For further information see page 925.  
 Illustrations about 1/4 size.



87



88



89



90



91



92



94



93



96



95

Drawer Pulls.

Fig.	Design.	Size in ins.	Fig.	Design.	Size in ins.
87,	Fontenoy, . . . .	$1\frac{1}{2} \times 5\frac{1}{2}$	92,	Portsmouth, . . . .	$1\frac{1}{2} \times 4\frac{1}{2}$
88,	Fronsac, . . . . .	$2 \times 1$	93,	Elne, . . . . .	$1\frac{1}{2}$ dia.
89,	Fronsac, . . . . .	$2\frac{5}{8} \times 1\frac{3}{8}$	94,	Fontenoy, . . . . .	$3\frac{1}{2} \times 5\frac{1}{2}$
90,	Fronsac, . . . . .	$2 \times 1$	95,	Toulouse, . . . . .	$1\frac{1}{2} \times 1\frac{1}{2}$
91,	Fontenoy, . . . . .	$1\frac{1}{2} \times 4\frac{1}{2}$	96,	Trianon, . . . . .	$1\frac{1}{4} \times 3$

For further information see page 925.

Illustrations about  $\frac{1}{4}$  size



97



98



99



100



101



102



103



104

### Drop Drawer Pulls.

Fig.	Design.	Size in ins.	Fig.	Design.	Size in ins.
97,	Alcazar, . . .	6 × 2	101,	Argos . . .	1 ¼ × 4 ½
98,	Athens, . . .	1 ¼ × 4 ½	102,	Florian, . . .	1 ½ × 3 ½
99,	Hellenian, . . .	1 ¾ × 4 ½	103,	Derby, . . .	2 × 4 ½
100,	Ionian, . . .	1 ¾ × 4 ½	104,	Largo, . . .	2 × 5 ¼

For further information see page 925.

Illustrations about ¼ size.



105



106



107



108



109



110



111



112

Drop Drawer Pulls.

Fig.	Design.	Size in ins.	Fig.	Design.	Size in ins.
105,	Marathon,	$1\frac{5}{8} \times 4$	109,	Navarro,	$1\frac{3}{4} \times 5\frac{3}{8}$
106,	Pasco,	$1\frac{3}{4} \times 4\frac{7}{8}$	110,	Woburn,	$1 \times 3\frac{7}{8}$
107,	Osaka,	$1\frac{3}{4} \times 4\frac{3}{4}$	111,	Oporto,	$1\frac{7}{8} \times 5\frac{1}{4}$
108,	Piedmont,	$1\frac{5}{8} \times 4\frac{1}{4}$	112,	Tiber,	$1\frac{1}{2} \times 4\frac{1}{2}$

For further information see page 925.

Illustrations about  $\frac{1}{4}$  size.

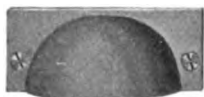

113



114



115



116

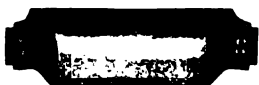

117



118



119



120

### Drawer Pulls.

No.	Fig.	Size in ins.	Each.*	No.	Fig.	Size in ins.	Each.*
W1052,	113	1 X 2½	\$ .20	W1056,	114	1 X 2½	\$ .20
W1053,	"	1½ X 3	.25	W1057,	"	1½ X 3½	.25
W1054,	"	1¾ X 3¾	.30	W1058,	"	1½ X 3¾	.30
175,	115	1½ X 3	.40	1061,	116	1½ X 2¾	.70
180,	"	1¾ X 3¾	.60	1062,	"	1¾ X 3¾	.80
283,	117	¾ X 3¾	.45	286,	118	¾ X 3¾	.40
1092,	119	1½ X 3¾	1.20	1299,	120	1½ X 3	1.00

\* Priced in Buffed Bronze (BZ10) or Brass (AZ10). For article on "Metals and Finishes" see page 595, and for Nomenclature of Finishes and explanation of Finish Symbols see page 609. Illustrations about ½ size.



121



122



124



123



125

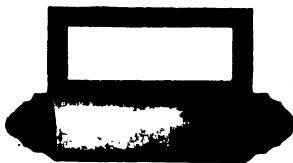

126



127



128

Drawer Pulls.

No.	Fig.	Size in ins.	Each.*	No.	Fig.	Size in ins.	Each.*
990,	121	1½ × 1½	\$.30	1369,	122	1¼ × 5¾	\$.90
991,	124	1⅝ × 1¼	.35	1368,	123	⅝ × 4½	.50
1040,	125	2 × 3½	.70	1041,	126	2¼ × 4½	1.00
1094,	127	1⅝ × 1⅝	4.00	1199,	128	1¼ × 4	1.00

\* Priced in Buffed Bronze (BZ10) or Brass (AZ10). For article on "Metals and Finishes" see page 595, and Nomenclature of Finishes and explanation of Finish Symbols see page 609. Illustrations about ⅓ size.



## Section 24.

### Drawer and Shutter Knobs.

Ornamental Drawer and Shutter Knobs illustrated on pages 942 and 943.

For clue to prices see pages 33 and 244.

Plain Drawer and Shutter Knobs illustrated and priced on page 796.

In specifying it must be stated whether for Drawer or Shutter, owing to method of attachment.

For information as to other pieces in these Designs see alphabetical list of all Designs on page 244.

For Designs arranged by Schools see page 236.

Design.	Size in ins.	Page.	Fig	Design.	Size in ins.	Page.	Fig.
Adria, . .	$1\frac{5}{8} \times \frac{3}{4}$	942	1	Ephesus, . .	$1\frac{1}{4}$	942	13
Amherst, . .	$1\frac{1}{8}$	"	2	Fairfax, . .	$1\frac{1}{8}$	"	2
Anet, . .	$1\frac{1}{4}$	"	3	Ferrara, . .	$1\frac{1}{8}$	"	16
Arcola, . .	$1\frac{1}{4}$	"	3	Firenze, . .	$1\frac{1}{8}$	"	17
Arlington, . .	$1\frac{1}{8}$	"	4	Fleury, . .	$1\frac{3}{4} \times \frac{3}{4}$	"	18
Austerlitz, . .	$1\frac{1}{8}$	"	5	Florentine, . .	1	"	19
Auvergne, . .	$1\frac{1}{4}$	"	6	Florian, . .	$1\frac{1}{8}$	"	20
Bonn, . .	$1\frac{1}{4}$	"	7	Fontenoy, . .	$1\frac{1}{8}$	"	21
Bristol, . .	$1\frac{5}{8} \times \frac{3}{4}$	"	1	" . .	$1\frac{1}{4} \times \frac{7}{8}$	"	22
Chambord, . .	$1\frac{3}{8} \times \frac{3}{4}$	*	*	" . .	$1\frac{3}{4} \times \frac{3}{4}$	"	18
Cluny, . .	$1\frac{1}{8}$	942	8	Heidelberg, . .	$1\frac{1}{8}$	"	23
Colonna, . .	$1\frac{1}{4}$	"	11	Hellenian, . .	$1\frac{3}{8} \times \frac{3}{4}$	"	24
Como, . .	$1\frac{1}{8}$	"	10	Hingham, . .	$1\frac{1}{8}$	"	25
Cordova, . .	$1\frac{1}{8}$	"	9	Ionian, . .	$1\frac{3}{8} \times \frac{3}{4}$	"	26
Corinth, . .	$1\frac{1}{4}$	"	12	Ituno, . .	$1\frac{3}{8}$	"	27
Dodona, . .	$1\frac{1}{4}$	"	13	Jamestown, . .	$1\frac{5}{8} \times \frac{1}{8}$	943	28
Dorchester, . .	$1\frac{1}{8}$	"	14	Jena, . .	$1\frac{5}{8} \times \frac{3}{4}$	942	1
Dormans, . .	$1\frac{1}{4}$	"	15	Kelp, . .	$1\frac{1}{8}$	943	29

\* Not illustrated.

Design.	Size in ins.	Page.	Fig.	Design.	Size in ins.	Page.	Fig.
Largo, . . .	1 $\frac{1}{8}$	942	10	Piedmont, . .	1 $\frac{5}{8} \times \frac{1}{8}$	*	*
Larissa, . . .	1 $\frac{1}{8}$	"	4	Plain, . . .	1	943	40
Lodi, . . .	1 $\frac{1}{8}$	"	17	" . . .	$\frac{3}{4}$	"	41
Lynn, . . .	1 $\frac{1}{8}$	943	30	" . . .	1	"	42
Lyons, . . .	1 $\frac{1}{8}$	"	31	" . . .	1 $\frac{1}{4}$	"	43
Madras, . . .	1 $\frac{1}{8}$	"	32	Plymouth, . .	1 $\frac{1}{8}$	"	44
Manchester, .	1 $\frac{1}{4}$	"	33	Realmont, . .	1 $\frac{1}{8}$	"	46
Mantua, . . .	$\frac{7}{8}$	"	34	Rhodes, . . .	1 $\frac{1}{8}$	"	44
Marathon, . .	1 $\frac{1}{8}$	"	35	Roanoke, . . .	1 $\frac{1}{8}$	"	47
Margaux, . . .	1 $\frac{1}{8}$	942	8	Rokeby, . . .	1 $\frac{1}{8}$	"	48
Marengo, . . .	1 $\frac{1}{8}$	"	5	Salem, . . .	1 $\frac{1}{8}$	"	49
Medici, . . .	1 $\frac{1}{8}$	"	17	St. Cloud, . .	1 $\frac{1}{8}$	942	5
Milan, . . .	1 $\frac{1}{4}$	943	36	Stenay, . . .	1 $\frac{1}{2} \times \frac{7}{8}$	943	50
Miletus, . . .	1 $\frac{1}{4}$	942	13	Tosca, . . .	1 $\frac{1}{4}$	"	33
Milford, . . .	1 $\frac{7}{8} \times 1$	943	37	Treviso, . . .	1 $\frac{1}{8}$	942	16
Navarro, . . .	1 $\frac{1}{4} \times \frac{1}{4}$	*	*	Trianon, . . .	1 $\frac{3}{8} \times 1 \frac{1}{8}$	943	51
Nimes, . . .	1 $\frac{7}{8} \times 1$	"	38	Tunis, . . .	1 $\frac{1}{8}$	942	9
Oriental, . . .	1	"	39	Urbino, . . .	1 $\frac{1}{8}$	943	52
Palermo, . . .	1 $\frac{1}{4}$	942	3	Valence, . . .	1 $\frac{1}{8}$	"	53
Palmyra, . . .	1 $\frac{1}{4}$	943	45	Wilmington, .	1 $\frac{1}{8}$	"	54
Petersham, . .	1 $\frac{1}{8}$	*	*	Woburn, . . .	1 $\frac{1}{4} \times \frac{1}{8}$	*	*

\* Not illustrated.

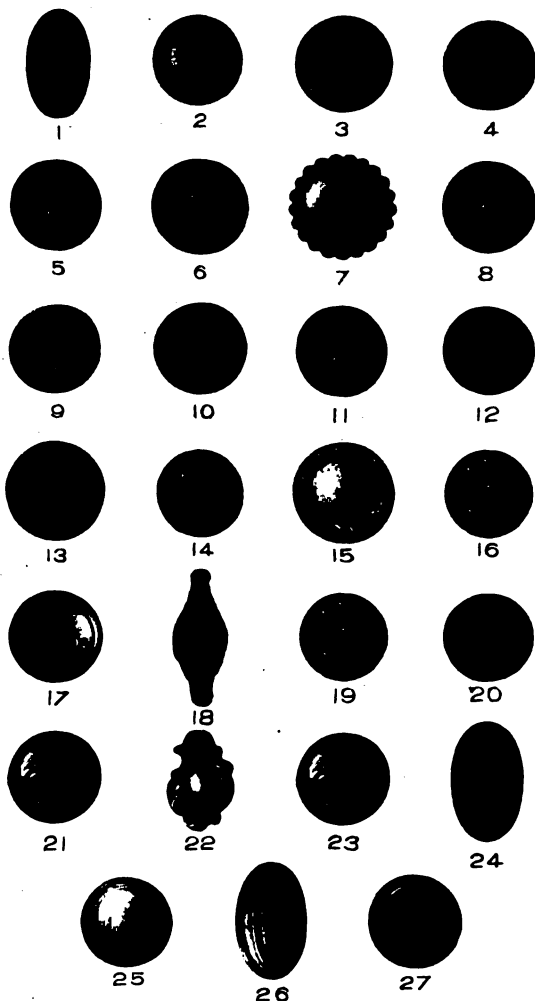

Ornamental Drawer and Shutter Knobs.

For information see page 940. Illustrations about  $\frac{1}{2}$  size



28



29



30



31



32



33



34



35



36



37



38



39



40



41



42



43



44



45



46



47



48



49



50



51



52



53



54

Ornamental Drawer and Shutter Knobs.

For information see page 940. Illustrations about 1/2 size.

## Section 25.

---

### Yale Glass Knobs.

Glass Door Knobs, illustrated on pages 949 and 950; priced on pages 944 and 945. The illustrations are made from the  $2\frac{1}{4}$  inch Knobs, but the cuttings of the  $1\frac{3}{4}$  inch Knobs are identical.

Glass Shutter Knobs, illustrated on page 951; priced on pages 946 and 947.

Glass Drawer Knobs, illustrated on page 951; priced on pages 947 and 948.

For article on "Metals and Finishes" see page 595, and for Nomenclature of Finishes and Explanation of Finish Symbols see page 609.

For Key Plates, suitable for association with Glass Knobs, see pages 952 to 960.

#### Glass Door Knobs.

No.	Description.	Size.	Page.	Fig.	Finish.	Pair.
G17,	Cut Oval, .	$2\frac{3}{4}$ ins. long,	949	2	BZ10,	\$ 9.00
G51,	Cut Spheroid	$2\frac{1}{4}$ inches,	"	3	"	10.75
G52,	" "	"	"	4	"	13.50
G53,	" "	"	"	5	"	10.00
G54,	" "	"	"	6	"	12.50
G57,	" "	"	"	8	"	8.25
G58,	" "	"	"	9	"	9.00
G59,	" "	"	"	10	"	12.50
G64,	Cut Octagon	"	"	11	"	16.25
G66,	" "	"	"	12	"	8.25
G67,	" "	"	950	13	"	10.75
G68,	" "	"	"	14	"	16.25
G69,	" "	"	"	15	"	16.25
G82,	Cut Sphere .	"	"	16	"	13.50
G83,	" "	"	"	17	"	21.50
G84,	" "	"	"	18	"	21.50

No.	Description.	Size.	Page.	Fig.	Finish.	Pair.
G85,	Cut Sphere .	2¼ inches,	950	19	BZ10,	\$21.50
G86,	" " .	"	"	20	"	6.75
G87,	" " .	"	"	21	"	12.50
G88,	" " .	"	"	22	"	21.50
G89,	" " .	"	"	23	"	21.50
G152,	Cut Spheroid	1¾ inches,	949	4	"	13.50
G153,	" " .	"	"	5	"	10.00
G154,	" " .	"	"	6	"	12.50
G157,	" " .	"	"	8	"	8.25
G158,	" " .	"	"	9	"	9.00
G159,	" " .	"	"	10	"	12.50
G164,	Cut Octagon	"	"	11	"	16.25
G166,	" " .	"	"	12	"	8.25
G167,	" " .	"	950	13	"	10.75
G168,	" " .	"	"	14	"	16.25
G169,	" " .	"	"	15	"	16.25
G182,	Cut Sphere .	"	"	16	"	13.50
G183,	" " .	"	"	17	"	21.50
G184,	" " .	"	"	18	"	21.50
G185,	" " .	"	"	19	"	21.50
G187,	" " .	"	"	21	"	12.50
G188,	" " .	"	"	22	"	21.50
G189,	" " .	"	"	23	"	21.30
Go14,	Pressed Oval	2¾ inches long,	949	1	"	4.50
Go56,	" Spheroid,	2¼ inches,	"	7	"	4.25
Go66,	" Octagon,	"	"	12	"	4.25
Go86,	" Sphere, .	"	950	20	"	4.75
Go90,	" " .	"	"	24	"	9.00
Go156,	" Spheroid,	1¾ inches,	949	7	"	4.25
Go166,	" Octagon,	"	949	12	"	4.25
Go186,	" Sphere, .	"	950	20	"	4.75

## Glass Shutter Knobs.

No.	Description.	Size.	Page.	Fig.	Finish.	Each.
G252,	Cut Spheroid	1 $\frac{3}{4}$ inches,	951	1	BZ10,	\$ 9.00
G253,	" "	"	"	3	"	6.50
G254,	" "	"	"	2	"	8.25
G257,	" "	"	"	5	"	5.50
G258,	" "	"	"	6	"	6.00
G259,	" "	"	"	11	"	8.25
G264,	Cut Octagon	"	"	8	"	10.75
G266,	" "	"	"	9	"	5.50
G267,	" "	"	"	10	"	7.25
G268,	" "	"	"	7	"	10.75
G269,	" "	"	"	12	"	10.75
G282,	Cut Sphere,	"	"	20	"	9.00
G283,	" "	"	"	15	"	14.50
G284,	" "	"	"	14	"	14.50
G285,	" "	"	"	16	"	14.50
G287,	" "	"	"	19	"	8.25
G288,	" "	"	"	18	"	14.50
G289,	" "	"	"	13	"	14.50
G452,	Cut Spheroid	1 $\frac{1}{4}$ inches,	"	1	"	6.75
G453,	" "	"	"	3	"	5.00
G454,	" "	"	"	2	"	6.25
G457,	" "	"	"	5	"	4.00
G458,	" "	"	"	6	"	4.50
G459,	" "	"	"	11	"	6.25
G464,	Cut Octagon	"	"	8	"	8.00
G466,	" "	"	"	9	"	4.00
G467,	" "	"	"	10	"	5.25
G468,	" "	"	"	7	"	8.00
G469,	" "	"	"	12	"	8.00

No.	Description.	Size.	Page.	Fig.	Finish.	Each.
G482,	Cut Sphere,	1 $\frac{1}{4}$ inches,	951	20	BZ10,	\$ 6.75
G483,	" "	"	"	15	"	10.75
G484,	" "	"	"	14	"	10.75
G485,	" "	"	"	16	"	10.75
G487,	" "	"	"	19	"	6.25
G488,	" "	"	"	18	"	10.75
G489,	" "	"	"	13	"	10.75
G0256,	Pressed Spheroid,	1 $\frac{3}{4}$ inches,	"	4	"	3.00
G0266,	" Octagon,	"	"	9	"	3.00
G0286,	" Sphere,	"	"	17	"	3.25
G0456,	" Spheroid,	1 $\frac{1}{4}$ inches,	"	4	"	2.25
G0466,	" Octagon,	"	"	9	"	2.25
G0486,	" Sphere,	"	"	17	"	2.50

## Glass Drawer Knobs.

No.	Description.	Size.	Page.	Fig	ish.	Each.
G252 $\frac{1}{2}$ ,	Cut Spheroid	1 $\frac{3}{4}$ inches,	951	1	BZ10,	\$ 9.00
G253 $\frac{1}{2}$ ,	" "	"	"	3	"	6.50
G254 $\frac{1}{2}$ ,	" "	"	"	2	"	8.25
G257 $\frac{1}{2}$ ,	" "	"	"	5	"	5.25
G258 $\frac{1}{2}$ ,	" "	"	"	6	"	6.00
G259 $\frac{1}{2}$ ,	" "	"	"	11	"	8.25
G264 $\frac{1}{2}$ ,	Cut Octagon	"	"	8	"	10.75
G266 $\frac{1}{2}$ ,	" "	"	"	9	"	5.25
G267 $\frac{1}{2}$ ,	" "	"	"	10	"	7.25
G268 $\frac{1}{2}$ ,	" "	"	"	7	"	10.75
G269 $\frac{1}{2}$ ,	" "	"	"	12	"	10.75
G282 $\frac{1}{2}$ ,	Cut Sphere	"	"	20	"	9.00
G283 $\frac{1}{2}$ ,	" "	"	"	15	"	14.50
G284 $\frac{1}{2}$ ,	" "	"	"	14	"	14.50
G285 $\frac{1}{2}$ ,	" "	"	"	16	"	14.50



No.	Description.	Size.	Page.	Fig.	Finish.	Each.
G287½,	Cut Sphere,	1¾ inches,	951	19	BZ10,	8.25
G288½,	" " .	"	"	18	"	14.50
G289½,	" " .	"	"	13	"	14.50
G452½,	Cut Spheroid	1¼ inches,	"	1	"	6.75
G453½,	" " .	"	"	3	"	5.00
G454½,	" " .	"	"	2	"	6.25
G457½,	" " .	"	"	5	"	4.00
G458½,	" " .	"	"	6	"	4.50
G459½,	" " .	"	"	11	"	6.25
G464½,	Cut Octagon	"	"	8	"	8.00
G466½,	" " .	"	"	9	"	4.00
G467½,	" " .	"	"	10	"	5.25
G468½,	" " .	"	"	7	"	8.00
G469½,	" " .	"	"	12	"	8.00
G482½,	Cut Sphere .	"	"	20	"	6.75
G483½,	" " .	"	"	15	"	10.75
G484½,	" " .	"	"	14	"	10.75
G485½,	" " .	"	"	16	"	10.75
G487½,	" " .	"	"	19	"	6.25
G488½,	" " .	"	"	18	"	10.75
G489½,	" " .	"	"	13	"	10.75
G0256½,	Pressed Spheroid	1¾ inches,	"	4	"	3.00
G0266½,	" Octagon,	"	"	9	"	3.00
G0286½,	" Sphere,	"	"	17	"	3.25
G0456½,	" Spheroid, 1¼ inches,	"	"	4	"	2.25
G0466½,	" Octagon,	"	"	9	"	2.25
G0486½,	" Sphere,	"	"	17	"	2.50



1



2



3



4



5



6



7



8



9



10

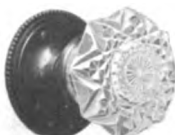

11



12

Glass Door Knobs.

For information see page 944. Illustrations about 1/4 size.

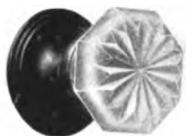

13



14



15



16



17



18



19



20



21



22



23



24

### Glass Door Knobs.

For information see page 944. Illustrations about  $\frac{1}{4}$  size.



1



2



3



4



5



6



7



8



9



10



11



12



13



14



15



16



17



18



19



20

Glass Shutter and Drawer Knobs.

For information see page 944. Illustrations about 1/4 size.

## Section 26.

### Key Plates.

Ornamental Key Plates illustrated on pages 957 to 960. For clue to prices see pages 33 and 244.

Plain Key Plates priced on page 705.

For information as to other pieces in these Designs see alphabetical index of all Designs on page 244.

For Designs arranged by Schools see page 236.

Design.	Size in ins.	Page.	Fig.	Design.	Size in ins.	Page.	Fig.
Adams, . .	$2\frac{7}{8} \times \frac{7}{8}$	957	1	Auvergne, . .	$2\frac{3}{4} \times 1\frac{1}{2}$	957	9
Alcazar, . .	$2\frac{3}{4} \times 1\frac{1}{8}$	"	2	" . .	$3 \times 1\frac{1}{4}$	*	*
Alencon, . .	$3\frac{1}{2} \times 1\frac{3}{8}$	*	*	Beauvais, . .	$2\frac{7}{8} \times \frac{7}{8}$	*	*
Amherst, . .	$2\frac{1}{2} \times 1\frac{1}{8}$	957	3	Beauvoir, . .	$1\frac{1}{8} \times 2\frac{5}{8}$	*	*
Angouleme, . .	$1 \times 4$	976	2	" . .	$1\frac{5}{8} \times 3\frac{5}{8}$	977	2
" . .	$3\frac{3}{8} \times \frac{7}{8}$	960	111	" . .	$3\frac{3}{8} \times 1\frac{5}{8}$	960	99
" . .	$4\frac{7}{8} \times 1$	976	1	Belfort, . .	$3\frac{1}{4} \times 1\frac{1}{4}$	957	11
Annapolis, . .	$2\frac{3}{8} \times \frac{7}{8}$	957	4	Beverly, . .	$3\frac{3}{8} \times 1\frac{1}{2}$	*	*
Arcadian, . .	$2 \times 1\frac{1}{4}$	"	14	" . .	$3\frac{3}{8} \times 2$	957	12
Argos, . .	$2\frac{1}{8} \times 1\frac{1}{4}$	"	5	Bondi, . .	$1\frac{3}{4} \times 3\frac{5}{8}$	"	13
Arlington, . .	$2\frac{3}{4} \times 1\frac{1}{4}$	"	6	" . .	$4\frac{3}{8} \times 1\frac{1}{4}$	*	*
Arno, . .	$2\frac{3}{4} \times 1$	"	7	Bonn, . .	$2\frac{3}{8} \times 1$	957	15
Arta, . .	$2\frac{7}{8} \times 1\frac{1}{4}$	"	8	" . .	$2\frac{5}{8} \times 1\frac{3}{8}$	*	*
Aubin, . .	$1\frac{1}{4} \times 2\frac{1}{2}$	*	*	Bothnian, . .	$2 \times 1\frac{1}{4}$	957	16
" . .	$2\frac{1}{2} \times 1\frac{1}{4}$	973	2	Boylston, . .	$2 \times 1\frac{1}{4}$	"	17
Aumont, . .	$3\frac{1}{4} \times 1\frac{1}{4}$	*	*	Brabant, . .	$2\frac{1}{8} \times 1\frac{1}{4}$	"	18
" . .	$5\frac{1}{8} \times 1\frac{3}{4}$	974	1	" . .	$2\frac{1}{4} \times 2$	*	*
" . .	$8\frac{1}{8} \times 2$	"	2	Bristol, . .	$1\frac{7}{8} \times \frac{3}{4}$	*	*
Austerlitz, . .	$3 \times \frac{7}{8}$	957	10	" . .	$1\frac{7}{8} \times \frac{7}{8}$	957	19

\* Not illustrated.

Design.	Size in ins.	Page.	Fig.	Design.	Size in ins.	Page.	Fig.
Bristol . . .	$1\frac{1}{2} \times \frac{3}{4}$	*	*	Cluny, . . .	$3\frac{1}{4} \times 1\frac{1}{2}$	*	*
" . . .	$1\frac{3}{4} \times 1$	*	*	Cohasset, . . .	$2\frac{3}{8} \times 1\frac{1}{4}$	957	25
" . . .	$1\frac{3}{4} \times 1\frac{1}{8}$	*	*	Colonna, . . .	$2\frac{5}{8} \times 1\frac{1}{8}$	"	26
" . . .	$2\frac{1}{8} \times 1$	*	*	Como, . . .	$2\frac{5}{8} \times 1\frac{3}{8}$	"	27
" . . .	$2\frac{5}{8} \times 1\frac{1}{8}$	*	*	Concord, . . .	$3\frac{5}{8} \times 1\frac{1}{4}$	977	2
Brockton, . . .	$2\frac{1}{8} \times 1\frac{1}{4}$	957	20	Dax, . . .	$1\frac{3}{8} \times 3\frac{1}{4}$	*	*
Caen, . . .	$3\frac{1}{8} \times \frac{7}{8}$	*	*	" . . .	$1\frac{3}{4} \times 1\frac{1}{2}$	957	28
" . . .	$3\frac{1}{8} \times 1\frac{1}{8}$	979	2	Dedham, . . .	$2\frac{1}{8} \times 1\frac{3}{8}$	"	29
" . . .	$3\frac{1}{4} \times \frac{7}{8}$	*	*	" . . .	$3 \times 1\frac{3}{8}$	*	*
" . . .	$3\frac{1}{4} \times 1\frac{1}{8}$	*	*	Derby, . . .	$1\frac{7}{8} \times \frac{3}{4}$	*	*
" . . .	$3\frac{1}{4} \times 1\frac{1}{2}$	*	*	Dorchester, . . .	$2\frac{1}{4} \times 1\frac{1}{2}$	957	30
" . . .	$3\frac{1}{4} \times 1\frac{3}{4}$	*	*	Dorian, . . .	$1 \times 1\frac{1}{4}$	"	31
" . . .	$5 \times 2\frac{3}{4}$	*	*	Dormans, . . .	$2 \times 1\frac{1}{8}$	"	32
" . . .	$6\frac{1}{4} \times 1\frac{1}{2}$	*	*	Dover, . . .	$1\frac{7}{8} \times 1\frac{1}{4}$	958	39
" . . .	$7\frac{1}{8} \times 2\frac{3}{4}$	*	*	Duro, . . .	$3 \times 1\frac{3}{8}$	"	33
" . . .	$7\frac{3}{4} \times 1\frac{1}{2}$	*	*	Ebro, . . .	$3 \times 1\frac{1}{4}$	"	34
Castilian, . . .	$2 \times 1\frac{1}{4}$	957	21	Elne, . . .	$1 \times 2\frac{3}{8}$	*	*
Chatillon, . . .	$2\frac{3}{8} \times 1\frac{3}{4}$	"	22	" . . .	$2\frac{3}{8} \times 1$	958	35
Chester, . . .	$1\frac{1}{2} \times \frac{7}{8}$	"	23	" . . .	$7\frac{1}{8} \times 1\frac{5}{8}$	980	2
" . . .	$2\frac{1}{8} \times 1$	*	*	Epernay, . . .	$2\frac{7}{8} \times 1\frac{1}{2}$	958	36
Clermont, . . .	$1\frac{3}{4} \times 2\frac{1}{4}$	*	*	Ephesus, . . .	$3 \times 1\frac{1}{8}$	"	37
" . . .	$2\frac{5}{8} \times 1$	*	*	Etrurian, . . .	$2 \times 1\frac{1}{4}$	"	38
" . . .	$2\frac{5}{8} \times 1\frac{1}{4}$	*	*	Fairfax, . . .	$1\frac{5}{8} \times 1\frac{1}{8}$	"	40
" . . .	$3 \times 1\frac{1}{4}$	*	*	Fassano, . . .	$2 \times \frac{3}{4}$	"	41
" . . .	$4\frac{1}{8} \times 1\frac{3}{8}$	979	3	Fermo, . . .	$2\frac{3}{4} \times 1\frac{1}{4}$	"	42
Cluny, . . .	$1\frac{1}{2} \times 3\frac{1}{4}$	*	*	Ferrara, . . .	$1\frac{1}{8} \times 3$	982	2
" . . .	$1\frac{3}{4} \times \frac{3}{4}$	975	1	" . . .	$2\frac{1}{4} \times \frac{7}{8}$	958	43
" . . .	$1\frac{3}{4} \times \frac{7}{8}$	*	*	" . . .	$2\frac{3}{8} \times 1$	*	*
" . . .	$1\frac{7}{8} \times \frac{3}{4}$	957	24	" . . .	$2\frac{3}{4} \times 1$	*	*
" . . .	$3\frac{1}{8} \times 1\frac{1}{2}$	975	2	" . . .	$4\frac{1}{4} \times 1$	*	*

\*Not illustrated.

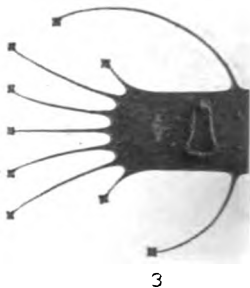

Combined Escutcheon Plates and Ring Pulls.

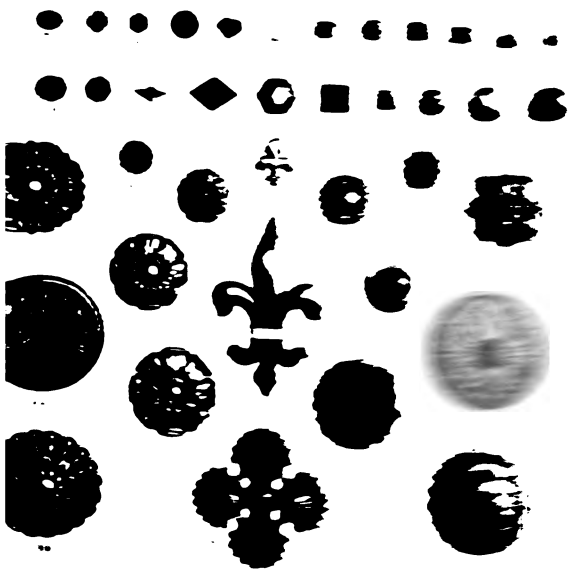

Ornamental Motifs

Medieval practice showed the use of...  
 the component parts of these...  
 are frequently of ornamental...  
 eric lines as a feature of...  
 other metal work of the...  
 though the construction is...  
 methods of woodwork...  
 in. A great variety of...  
 of which a few examples...  
 they are made in various...  
 which can be seen in...  
 head in plate. When...  
 to the decoration of...  
 exterior doors or...



Design.	Size in ins.	Page.	Fig.	Design.	Size in ins.	Page.	Fig.
Ferrara, . . .	5 × 1 1/8	*	*	Ivry, . . .	1 × 5 7/8	985	2
Firenze, . . .	2 5/8 × 3/4	958	44	" . . .	6 1/2 × 7/8	"	4
" . . .	3 1/4 × 1	*	*	Jamestown, . . .	2 1/4 × 7/8	958	58
Fleury, . . .	3 1/4 × 1 1/4	958	45	Jarnac, . . .	1 3/4 × 1 3/4	960	113
Florentine, . . .	3 1/8 × 1 1/8	"	46	" . . .	1 7/8 × 5/8	*	*
Florian, . . .	1 3/4 × 1 1/8	"	48	" . . .	2 1/8 × 2 1/8	980	6
Fontenoy, . . .	1 × 3	*	*	Jennico, . . .	2 × 1	958	60
" . . .	3 × 7/8	958	47	Kelp, . . .	1 1/4 × 2 1/2	983	6
" . . .	3 × 1	*	*	" . . .	2 1/2 × 1 1/4	"	2
" . . .	4 5/8 × 5/8	*	*	" . . .	2 5/8 × 1 1/2	958	61
Fronsac, . . .	2 × 1 1/2	959	84	Lagrasse, . . .	1 5/8 × 4 1/8	960	112
Gardo, . . .	3 × 1 3/8	958	49	" . . .	4 1/8 × 1 5/8	*	*
Germantown, . . .	2 3/8 × 1	"	50	Largo, . . .	2 7/8 × 1 1/4	959	63
Gordian, . . .	3 × 1 1/2	"	51	Larissa, . . .	2 1/4 × 7/8	"	64
Grenoble, . . .	3 1/8 × 1 1/4	"	52	Lexington, . . .	5 1/2 × 2 3/8	985	3
Heidelberg, . . .	2 1/2 × 1	"	53	" . . .	5 1/2 × 2 1/2	960	106
Hellenian, . . .	2 1/2 × 1 1/4	"	54	Lodi, . . .	2 5/8 × 3/4	959	65
Hingham, . . .	1 × 2	*	*	" . . .	3 1/4 × 1	*	*
" . . .	1 1/4 × 2	*	*	Louisburg, . . .	1 3/4 × 1 3/8	959	66
" . . .	1 1/4 × 2 3/8	984	4	Lowell, . . .	1 3/4 × 1 1/8	958	62
" . . .	1 3/8 × 5/8	"	2	Lynn, . . .	1 7/8 × 1 1/4	959	67
" . . .	2 × 1	958	55	" . . .	2 × 1	*	*
" . . .	2 × 1 1/4	*	*	Lyons, . . .	1 7/8 × 5/8	959	68
" . . .	2 3/8 × 1 1/4	*	*	" . . .	2 1/2 × 1 1/8	*	*
" . . .	2 1/2 × 1 1/8	958	3	Madras, . . .	1 3/4 × 1	959	69
" . . .	3 × 7/8	*	*	Mailly, . . .	3 1/8 × 1 1/4	"	70
Hondo, . . .	3 × 1 1/8	958	56	Manchester, . . .	1 1/2 × 2 3/8	*	*
" . . .	3 × 1 1/4	*	*	" . . .	1 7/8 × 3 5/8	959	71
Ionian, . . .	2 1/2 × 1 1/4	958	57	Manhattan, . . .	2 × 1 1/4	"	72
Ituno, . . .	2 1/4 × 1 1/4	"	59	Mansfield, . . .	1 7/8 × 1	"	73

\* Not illustrated.

Design.	Size in ins.	Page.	Fig.	Design.	Size in ins.	Page.	Fig.
Marathon, .	$2 \times 1\frac{1}{4}$	959	74	Salem, . .	$2\frac{1}{8} \times \frac{5}{8}$	959	91
Medford, .	$1\frac{3}{4} \times \frac{5}{8}$	*	*	“ . .	$3 \times 1\frac{1}{2}$	*	*
“ . .	$2\frac{1}{8} \times \frac{7}{8}$	959	75	Savona, . .	$1\frac{7}{8} \times 1\frac{1}{8}$	960	92
“ . .	$2\frac{3}{8} \times 1\frac{1}{8}$	*	*	Saybrook, .	$1\frac{3}{4} \times 1\frac{1}{4}$	“	93
Medici, . .	$2\frac{5}{8} \times \frac{3}{4}$	*	*	Sparta, . .	$2 \times 1$	“	94
“ . .	$3\frac{1}{4} \times 1$	959	76	St. Cloud, .	$1\frac{3}{8} \times 5\frac{1}{8}$	*	*
Milan, . .	$2\frac{1}{8} \times 1$	988	2	“ . .	$2\frac{3}{8} \times \frac{1}{2}$	988	4
“ . .	$3\frac{1}{8} \times \frac{7}{8}$	“	5	“ . .	$4\frac{3}{4} \times 1\frac{1}{8}$	“	5
Monaco, . .	$2\frac{3}{4} \times 1$	959	77	“ . .	$5\frac{1}{8} \times 1\frac{3}{4}$	960	95
Montauban, .	$2\frac{7}{8} \times 1\frac{7}{8}$	“	78	Stonington, .	$2\frac{1}{4} \times 1\frac{1}{4}$	594 <sup>B</sup>	21
Nantucket, .	$2\frac{1}{8} \times 1$	*	*	Strabo, . .	$1\frac{3}{4} \times 1\frac{3}{8}$	960	96
Navarro, . .	$2\frac{3}{4} \times 1\frac{1}{8}$	959	79	“ . .	$3 \times 1\frac{3}{8}$	*	*
Oporto, . .	$2\frac{7}{8} \times 1\frac{1}{4}$			Stratford, .	$2 \times 1$	960	97
Oriental, . .	$1\frac{5}{8} \times 1$	959	80	“ . .	$4 \times 1$	*	*
Osaka, . .	$2\frac{1}{4} \times 1$	“	81	Tiber, . .	$2\frac{3}{4} \times 1\frac{1}{8}$	960	100
Pasco, . .	$2\frac{3}{4} \times 1\frac{1}{4}$	594 <sup>B</sup>	23	Tosca, . .	$2\frac{1}{4} \times \frac{3}{4}$	*	*
Petersham, .	$1\frac{1}{8} \times 2$	*	*	Tours, . .	$1\frac{3}{4} \times 4\frac{1}{2}$	989	2
“ . .	$1\frac{7}{8} \times \frac{7}{8}$	959	82	“ . .	$3\frac{1}{8} \times 1\frac{1}{8}$	*	*
Piedmont, . .	$2 \times \frac{7}{8}$	594 <sup>B</sup>	22	“ . .	$3\frac{3}{4} \times 1\frac{1}{2}$	*	*
Plain, . .	$2\frac{1}{8} \times 1$	959	85	“ . .	$4\frac{1}{2} \times 1\frac{3}{4}$	960	98
Plymouth, .	$2\frac{1}{8} \times 1$	*	*	Trenton, . .	$2\frac{1}{4} \times 1\frac{1}{8}$	“	103
“ . .	$2\frac{1}{4} \times 1\frac{1}{4}$	*	*	Trianon, . .	$1\frac{3}{4} \times 1\frac{1}{8}$	“	101
“ . .	$2\frac{3}{8} \times 1\frac{1}{8}$	*	*	“ . .	$2\frac{3}{8} \times \frac{7}{8}$	*	*
“ . .	$2\frac{3}{8} \times 1\frac{1}{4}$	959	83	“ . .	$2\frac{5}{8} \times 1\frac{1}{2}$	*	*
“ . .	$2\frac{3}{8} \times 1\frac{3}{8}$	986	7	Tunis, . .	$1\frac{3}{8} \times 3\frac{1}{8}$	*	*
Realmont, . .	$2 \times 1\frac{1}{8}$	959	86	“ . .	$3\frac{3}{8} \times 2$	960	102
Rennes, . .	$2\frac{3}{4} \times 2\frac{1}{8}$	“	87	Urbino, . .	$\frac{7}{8} \times 3$	987	3
Roanoke, . .	$1\frac{3}{4} \times \frac{3}{4}$	“	88	“ . .	$1\frac{1}{8} \times 3\frac{1}{8}$	*	*
Rokeby, . .	$2 \times 1\frac{1}{4}$	“	89	“ . .	$2\frac{1}{4} \times \frac{3}{4}$	*	*
Saarbruck, .	$1\frac{1}{2}$ dia.	“	90	“ . .	$3 \times \frac{7}{8}$	*	*

\* Not illustrated.

Design.	Size in ins.	Page.	Fig.	Design.	Size in ins.	Page.	Fig.
Urbino, . . .	$3 \times 1\frac{1}{8}$	960	104	Valence, . . .	$3\frac{1}{2} \times 1\frac{1}{8}$	960	105
" . . .	$3\frac{1}{8} \times 1\frac{1}{8}$	987	5	Weymouth, . . .	$2 \times 1\frac{1}{8}$	"	107
" . . .	$3\frac{3}{4} \times 1$	"	4	Wilton, . . .	$1\frac{1}{2} \times 1$	"	108
" . . .	$3\frac{7}{8} \times 1$	*	*	Woburn, . . .	$1\frac{1}{4} \times 2\frac{5}{8}$	*	*
Valence; . . .	$2 \times 1$	*	*	" . . .	$2\frac{5}{8} \times 1\frac{1}{4}$	960	109
" . . .	$2\frac{3}{4} \times \frac{7}{8}$	*	*	Yorktown, . . .	$2 \times 1\frac{1}{8}$	"	110

\* No. illustrated.

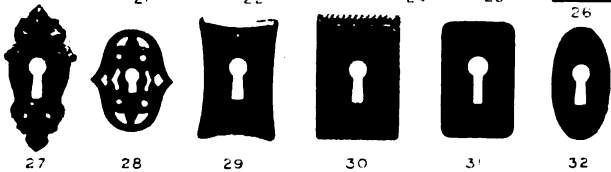
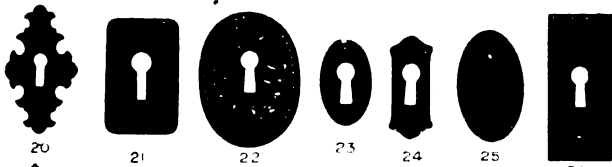
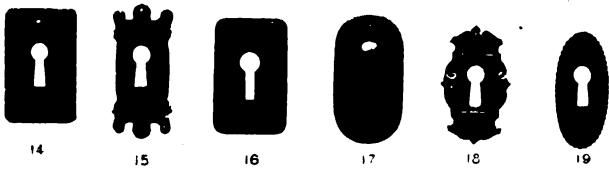
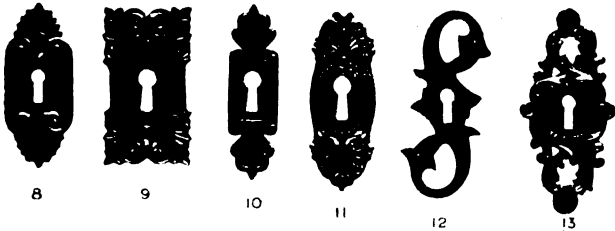
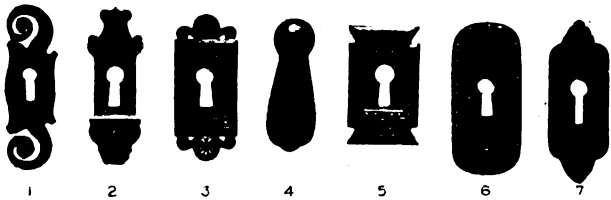

Ornamental Key Plates.

For information see page 952. Illustrations about  $\frac{1}{3}$  size

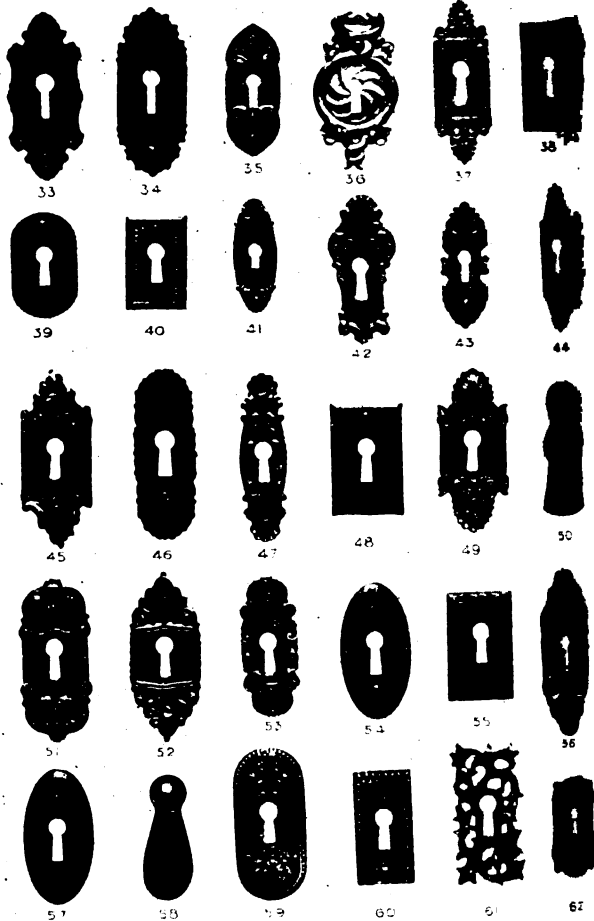

### Ornamental Key Plates.

For information see page 952. Illustrations about  $\frac{1}{2}$  size.

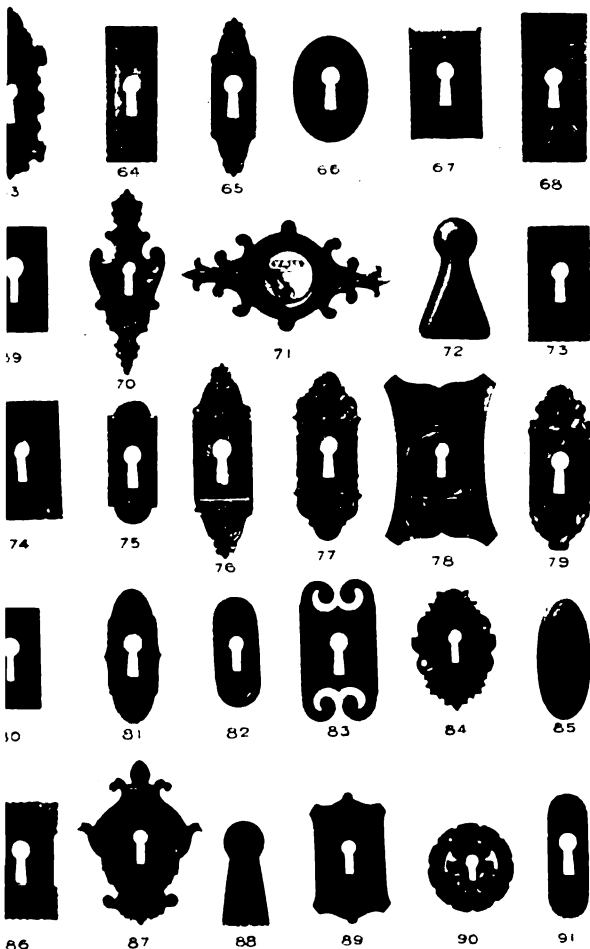

Ornamental Key Plates.

For information see page 952. Illustrations about  $\frac{1}{3}$  size.

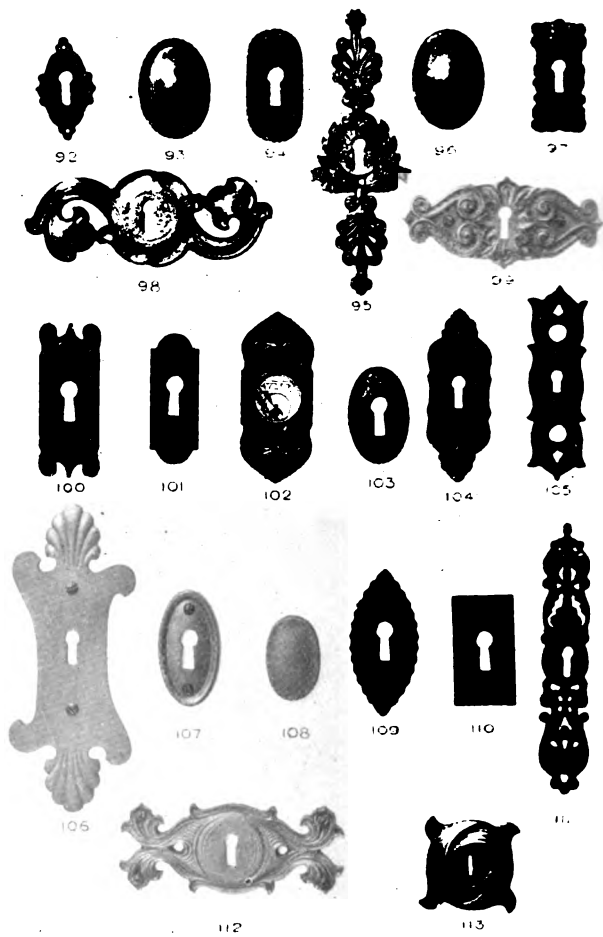

Ornamental Key Plates.

For information see page 952. Illustrations about 1/3 size.

## Part VIII.

---

### Cabinet Hardware.



## Part VIII.

---

### Cabinet Hardware.

	Page.
1. Designs Alphabetically arranged, . . . . .	963-972D
2. Drawer Pulls, . . . . .	925-939
3. Key Plates, . . . . .	952-960
4. Metal Drawer and Shutter Knobs, . . . . .	940-943
5. Glass " " " " . . . . .	946-951
6. Hinge and Corner Plates, . . . . .	847-866

---

For Index of Designs arranged by Schools  
see page 236.

## Section 1.

### Yale & Towne Designs, alphabetically arranged.

*The Multipliers indicate the relative prices of the various designs and finishes as compared with prices of corresponding pieces in the Cluny Design, Copper Finish (CX22), given below, and on pages 734 and 735. For further explanation of Multipliers see page 34.*

*For Explanation of Finish Symbols see page 609.*

#### CLUNY—Romanesque, page 975, . . . 18 pieces, including

Name	Size in ins.	Fig.	Each.†	Name.	Size in ins.	Fig.	Each.†
Drawer Pull,	1 1/2 X 5 1/8	6	\$2.10	Hinge Plate,			
“ “	2 X 6	7	2.10	“ “	7 1/8 X 5 7/8 X 1 1/2	*	2.75
“ “	2 X 6 1/4	*	2.35	Hinge Plate,	9 X 1 1/2	5	4.75
Esc'n Plate,	5 1/4 X 1 1/2	*	.90	Key Plate,	1 1/2 X 3 1/4	*	.45
“ “	5 X 7/8	*	.90	“ “	3 1/8 X 1 1/2	2	.45
Hinge Plate,				“ “	3 1/4 X 1 1/2	*	.45
“ “	5 3/4 X 5 3/4 X 1 1/2	1&4	2.65	“ “	1 3/4 X 3/4	1	.45
Hinge Plate,				Knob, . . .	1 1/8	*	1.50
“ “	9 1/4 X 5 3/4 X 1 1/2	8&9	4.85	T-H'dle Plate,	4 X 1	*	.60

Appropriate Finishes: Copper (CX22) Base, as above; Silver (SX52) Mult'r 1.75; Iron (FX80) Mult't .75

#### ADAMS—Colonial, Fig. 1, page 957, . . . 2 pieces, including

Drawer Pulls, . . . p. 925                      Key Plates, . . . p. 952

Appropriate Finishes: Bronze (BZ10) Mult'r 7.5; Copper (CY22) Mult'r 7.6; Iron (FX80) Mult'r 5.

#### ALCAZAR—Spanish Ren's, Fig. 97, page 937C, 2 pieces, including

Drawer Pulls, . . . p. 925                      Key Plates, . . . p. 952

Appropriate Finishes: Copper (CY22) Mult'r 2.; Silver (SY52) Mult'r 2.6; Gold (GY10) Mult'r 10.; Iron (FX80) Mult'r 1.4

\* Not illustrated.      † Old Copper Finish (CX22).

AMHERST—Colonial, Fig. 71, page 937, . 8 pieces, including

Escutcheon Plates, . . . p. *	Drawer Pulls, . . . p. 925
T-Handle Plates, . . . " *	Key Plates, . . . " 952
Drawer Knobs, . . . " 940	

Appropriate Finishes: Bronze (BZ10) Mult'r 2.75; Copper (CY22) Mult'r 2.8; Brass (AY22) Mult'r 2.8; Silver (SY52) Mult'r 3.4; Gold (GY10) Mult'r 8.9; Hand Chasing, Mult'r .85 additional.

ANGOULEME—French Ren's, page 976, . 8 pieces, including

Drawer Pulls, . . . p. 925	Key Plates, . . . p. 952
----------------------------	--------------------------

Appropriate Finishes: Brass (AZ15) Mult'r 3.; Copper (CY22) Mult'r 3.; Silver (SY52) Mult'r 3.5, (SY55) Mult'r 4.2; Gold (GY10) Mult'r. 9.2

ANNAPOLIS—Colonial, Fig. 72, page 937, . 5 pieces, including

Drawer Pulls, . . . p. 925	Key Plates, . . . p. 952
----------------------------	--------------------------

Appropriate Finishes: Brass (AZ10) Mult'r .65; Copper (CY22) Mult'r .7; (CX22) .7; Silver (SY52) Mult'r .9; Gold (GY10) Mult'r 3.; Iron (FX80) Mult'r .55

ARGOS—Greek, Fig. 101, page 937c, . 2 pieces, including

Drawer Pulls, . . . p. 925	Key Plates, . . . p. 952
----------------------------	--------------------------

Appropriate Finishes: Brass (AZ15) Mult'r 1.7; Copper (CX22) Mult'r 1.7; Silver (SX52) Mult'r 2.25; Iron (FX80) Mult'r .95

ARNO—Italian Renaissance, Fig. 7, page 957, 2 pieces, including

Drawer Pulls, . . . p. 925	Key Plates, . . . p. 952
----------------------------	--------------------------

Appropriate Finish: Copper Plated (FCZ17) Mult'r .25

AUBIN—Colonial, Figs. 1 to 10, page 973, 8 pieces, including

Hinge Plates, . . . p. 847	Key Plates, . . . p. 952
----------------------------	--------------------------

Appropriate Finishes: Brass (AZ10) Mult'r 1.2; Copper (CY22) Mult'r 1.3; Silver (SY52) Mult'r 2.2; Gold (GY10) Mult'r 10.5; Iron (FX80) Mult'r 1.2

AUMONT—Romanesque, page 974, . 9 pieces, including

Escutcheon Plates, . . . p. *	Drawer Pulls, . . . p. 925
-------------------------------	----------------------------

Hinge Plates, . . . " 847	Key Plates, . . . " 952
---------------------------	-------------------------

Appropriate Finishes: Copper (CX22) Mult'r 1.4; Silver (SX52) Mult'r 2.1; Iron (FX80) Mult'r 1.1

\*Not illustrated.

**AUSTERLITZ—Empire, Fig. 28, page 932, 5 pieces, including**

Escutcheon Plates, . p. *	Drawer Pulls, . . p. 925
Thumb-piece Plates, " *	Key Plates, . . " 952

Appropriate Finishes: Brass (AZ15) Mult'r 1.5 ; Copper (CY22) Mult'r 1.5 ; (CX22) Mult'r 1.5 ; Silver (SX52) Mult'r 2.25, (SY55) Mult'r 3.1 ; Gold (GY10) Mult'r 9.75

**AUVERGNE—Romanesque, Fig. 9, page 957, 7 pieces, including**

Escutcheon Plates, . p. *	Drawer Pulls, . . p. 925
Thumb-piece Plates, " *	Key Plates, . . " 952

Drawer Knobs, . . " 940

Appropriate Finishes: Brass (AZ15) Mult'r 1.4 ; Copper (CX22) Mult'r 1.4 ; Silver (SX52) Mult'r 1.9 ; Iron (FX80) Mult'r 1.

**BEAUVOIR—Romanesque, page 977, . 5 pieces, including**

Hinge Plates, . . p. 848	Key Plates, . . . p. 952
--------------------------	--------------------------

Drawer Pulls, . . " 925

Appropriate Finishes: Copper (CX22) Mult'r 2.6 ; Silver (SX52) Mult'r 3.8 ; Gold (GX10) Mult'r 14.4 ; Iron (FX80) Mult'r 2.2

**BEVERLY—Colonial, Figs. 1 to 5, page 976, 8 pieces, including**

Hinge Plates, . . p. 848	Drawer Pulls, . . p. 925
Strap Hinges, . . " 848	Key Plates, . . . " 952

Appropriate Finishes: Brass (AZ10) Mult'r 2.8 ; (AY22) Mult'r 3.4 ; Copper (CX22) Mult'r 3.4 ; Silver (SY10) Mult'r 3.8

**BONN—German Ren's, Fig. 2, page 929, 5 pieces, including**

Escutcheon Plates, . p. *	Drawer Pulls, . . p. 925
Drawer Knobs, . . " 940	Key Plates, . . . " 952

Appropriate Finishes: Brass (AX10) Mult'r 1.4 ; Copper (CX22) Mult'r 1.4 ; Silver (SX52) Mult'r 2. ; Iron (FX80) Mult'r .85

**BRISTOL—Colonial, Fig. 33, page 933, 20 pieces, including**

Escutcheon Plates, . p. *	Corner Plates, . . p. 849
T-Handle Plates, . " *	Cabinet Pulls, . . " *
Lever Handle Plates, " *	Drawer Pulls, . . " 925
Thumb-piece Plates, " *	Key Plates, . . . " 952

Drawer Knobs, . . " 940

Appropriate Finishes: Brass (AZ10) Mult'r .9 ; (AY22) Mult'r 1. ; Bronze (BZ10) Mult'r .9 ; Copper (CX22) Mult'r 1. ; Silver (SY52) Mult'r 1.7 ; Iron (FX80) Mult'r .7

\* Not illustrated.

**BROCKTON**—Colonial, Figs. 51-55, page 935, 7 pieces, including

Drawer Pulls, . . . p. 926                      Key Plates, . . . p. 953  
 Appropriate Finishes: Brass (AZ10) Mult'r .9, (AY22) Mult'r .95; Copper (CX22) Mult'r .95; Silver (SY52) Mult'r 1.4

**CAEN**—German Gothic, page 979, . . . 23 pieces, including

Hinge Plates, . . . p. 849                      Drawer Pulls, . . . p. 926  
 Corner Plates, . . . " 849                      Key Plates, . . . " 953  
 Appropriate Finishes: Copper (CX22) Mult'r 2.; Silver (SX52) Mult'r 2.8, (SY55) Mult'r 3.7; Gold (GX12) Mult'r 10.6; Iron (FX80) Mult'r 1.5

**CHESTER**—Colonial, Fig. 23, page 957, . . . 7 pieces, including

Escutcheon Plates, . . . p. \*                      Drawer Pulls, . . . p. 926  
 Thumb-piece Plates, " \*                      Key Plates, . . . " 953  
 Appropriate Finishes: Bronze (BZ10) Mult'r .9; Brass (AZ10) Mult'r .9; Copper (CY22) Mult'r 1.; Silver (SY52) Mult'r 1.7; Iron (FX80) Mult'r .7

**CLERMONT**—Romanesque, page 979, . . . 12 pieces, including

Hinge Plates, . . . p. 849                      Key Plates, . . . p. 953  
 Drawer Pulls, . . . " 926  
 Appropriate Finishes: Copper (CX22) Mult'r 1.2; Silver (SX52) Mult'r 1.7; Gold (GX10) Mult'r 7.8; Iron (FX80) Mult'r .85

**CLUNY**—Romanesque, see page 963.**COLONNA**—Colonial, Fig. 26, page 957, . . . 4 pieces, including

Thumb-piece Plates, p. \*                      Drawer Pulls, . . . p. 926  
 Drawer Knobs, . . . " 940                      Key Plates, . . . " 953  
 Appropriate Finishes: Bronze (BZ10) Mult'r .9; Copper (CY22) Mult'r 1.; Silver (SY52) Mult'r 1.5; Iron (FX80) Mult'r .6

**COMO**—French Ren's, Fig. 27, page 957, . . . 3 pieces, including

Drawer Knobs, . . . p. 940                      Key Plates, . . . p. 953  
 Drawer Pulls, . . . " 926  
 Appropriate Finish: Copper (CX22) Mult'r .85

\* Not illustrated.

**CONCORD**—Colonial, page 977, . . . 4 pieces, including  
 Hinge Plates, . . . p. 850      Key Plates, . . . p. 953  
 Drawer Pulls, . . . " 926  
 Appropriate Finishes: Brass (AZ10) Mult'r 1.8, (AY22) Mult'r  
 1.9; Copper (CX22) Mult'r 1.9; Silver (SY10) Mult'r 2.7

**DAX**—Romanesque, page 978 . . . 5 pieces, including  
 Hinge Plates, . . . p. 850      Key Plates, . . . p. 953  
 Drawer Pulls, . . . " 926  
 Appropriate Finishes: Copper (CX22) Mult'r 1.; Silver (SX52)  
 Mult'r 1.5; Iron (FX80) Mult'r .8

**DERBY**—Colonial, Fig. 103, page 937C, 3 pieces, including  
 Drawer Pulls, . . . p. 926      Key Plates, . . . p. 953  
 Drawer Knobs, . . . " \*  
 Appropriate Finishes: Bronze (BZ10) Mult'r 1.6; Copper (CX22)  
 Mult'r 1.8; Silver (SY10) Mult'r 2.; Gold (GY10) Mult'r 6.

**ELNE**—Romanesque, page 980, . . . 9 pieces, including  
 Hinge Plates, . . . p. 850      Key Plates, . . . p. 953  
 Drawer Pulls, . . . " 926  
 Appropriate Finishes: Copper (CX22) Mult'r 1.3; Silver (SX52)  
 Mult'r 1.9

**EPERNAY**—French Gothic, page 978, 3 pieces, including  
 Hinge Plates, . . . p. 850      Key Plates, . . . p. 953  
 Drawer Pulls, . . . " 926  
 Appropriate Finishes: Copper (CX22) Mult'r 1.8; Silver (SX52)  
 Mult'r 2.6

**EPHESUS**—Greek, Fig. 11, page 930, 4 pieces, including  
 Escutcheon Plates, . p. \*      Drawer Pulls, . . . p. 926  
 Drawer Knobs, . . . " 940      Key Plates, . . . p. 953  
 Appropriate Finishes: Brass (AY22) Mult'r 1.7; Copper (CX22)  
 Mult'r 1.7; Bronze (BX67) Mult'r 2.3; Gold (GX10) Mult'r 9.6;  
 Iron (FX80) Mult'r 1.

**FAIRFAX**—Colonial, Fig. 34, page 933, 8 pieces, including  
 Escutcheon Plates, . p. \*      Drawer Pulls, . . . p. 926  
 Thumb-piece Plates, " \*      Key Plates, . . . " 953  
 Drawer Knobs, . . . " 940  
 Appropriate Finishes: Brass (AZ10) Mult'r 2.5; Bronze (BZ10)  
 Mult'r 2.5; Copper (CY22) Mult'r 2.6; Silver (SY52) Mult'r 3.2  
 Gold (GY10) Mult'r 9.; Hand Chasing, Mult'r .5 additional.

\*Not illustrated.

**FERRARA**—Italian Renaissance, page 982, 23 pieces, including

Escutcheon Plates, . . p. 982	Drawer Pulls, . . . p. 926
T-Handle Plates, . . " 982	Thumb-pieces, . . . " 982
Hinge Plates, . . . " 850	Key Plates, . . . " 953
Drawer Knobs, . . . " 940	

Appropriate Finishes: Copper (CY22) Mult'r 3.25; Silver (SX52) Mult'r 3.75; Gold (GZ10) Mult'r 10.; Hand Chasing, Mult'r 2.6 additional.

**FIRENZE**—Italian Ren's. Fig. 12, page 930, 4 pieces, including

Drawer Knobs, . . . p. 940	Key Plates, . . . p. 954
Drawer Pulls, . . . " 926	

Appropriate Finishes: Copper (CY22) Mult'r 2.2; Brass (AY22) Mult'r 2.2; Silver (SX52) Mult'r 2.9, (SY55) Mult'r 3.7; Gold (GZ10) Mult'r 11.; Iron (FX80) Mult'r 1.6

**FLEURY**—Louis XV. Fig. 6, page 929, 3 pieces, including

Drawer Knobs, . . . p. 940	Key Plates, . . . p. 954
Drawer Pulls, . . . " 926	

Appropriate Finishes: Copper (CX22) Mult'r 1.2; Silver (SX52) Mult'r 2., (SY55) Mult'r 2.5; Gold (GX10) Mult'r 8.; Iron (FX80) Mult'r .85

**FLORIAN**—Modern Ren's. Fig. 102, p. 937C, 6 pieces, including

Drawer Knobs, . . . p. 940	Key Plates, . . . p. 954
Drawer Pulls, . . . " 926	

Appropriate Finishes: Bronze (BZ36) Mult'r .25; Steel (SBZ4) and Iron (FBZ4) Mult'r .15

**FONTENOY**—Louis XV, Fig. 4, page 929, 13 pieces, including

Escutcheon Plates, . . p. *	Drawer Knobs, . . . p. 940
Thumb-piece Plates, " *	Drawer Pulls, . . . " 926
Hinge Plates, . . . " 850	Key Plates, . . . " 954

Appropriate Finishes: Brass (AZ15) Mult'r 2.7; Copper (CY22) Mult'r 2.7; Silver (SY52) Mult'r 3.25; Gold (GY10) Mult'r 10.; Hand Chasing, Mult'r 1.5 additional.

**GARDO**—Greek. Fig. 49, page 958, . . 5 pieces, including

Escutcheon Plates, . . p. *	Drawer Pulls, . . . p. 927
Corner Plates, . . . " 851	Key Plates, . . . " 954

Appropriate Finishes: Bronze (BZ10) Mult'r .7; Copper (CX22) Mult'r .7; Silver (SX52) Mult'r 1.25

\*Not illustrated.

**GRENOBLE**—French Ren's, Fig. 52, page 958, 3 pieces, including

T or Lever Handle	Drawer Pulls, . . . p. 927
Plates, . . . p. *	Key Plates, . . . " 954
Appropriate Finishes: Copper (CX22) Mult'r .95; Silver (SX52) Mult'r 1.6; Iron (FX80) Mult'r .7	

**HEIDELBERG**—German Ren's, Fig. 15, page 930, 3 pieces, including

Drawer Knobs . . . p. 940	Key Plates, . . . p. 954
Drawer Pulls, . . . p. 927	
Appropriate Finishes: Copper (CY22) Mult'r 2.8; Silver (SX52) Mult'r 3.6; Gold (GY10) Mult'r 13.3; Iron (FX80) Mult'r 2.	

**HELLENIAN**—Colonial, Fig. 99, page 737c, 6 pieces, including

Escutcheon Plates, . p. *	Drawer Pulls, . . . p. 927
T or Lever H'dle, . " *	Key Plates, . . . " 954
Drawer Knobs, . . . " 940	
Appropriate Finishes: Brass (AZ10) Mult'r .35; Copper (CZ17) Mult'r .35; Silver (SY52) Mult'r .8	

**HINGHAM**—Colonial, page 983, . . . 30 pieces, including

Escutcheon Plates, . p. *	Drawer Pulls, . . . " 927
Thumb-piece Plates, " *	Drawer Knobs, . . . " 940
Hinge Plates, . . . " 851	Key Plates, . . . " 954
Corner Plates, . . . " 851	
Appropriate Finishes: Bronze (BZ10) Mult'r 1.; Copper (CY22) Mult'r 1.1; Brass (AY22) Mult'r 1.1; Silver (SY52) Mult'r 1.5; Gold (GZ10) Mult'r 6.7; Iron (FX80) Mult'r .75	

**HONDO**—German Ren's, Fig. 56, page 958, 5 pieces, including

Escutcheon Plates, . p. *	Drawer Pulls, . . . p. 927
Corner Plates, . . . " 851	Key Plates, . . . " 954
Appropriate Finishes: Bronze (BZ10) Mult'r .85; Copper (CX22) Mult'r .85; Silver (SX52) Mult'r 1.5	

**IONIAN**—Colonial, Fig. 100, page 937c, . . . pieces, including

Escutcheon Plates, . p. *	Drawer Pulls, . . . p. 927
T or Lever H'dle, . " *	Key Plates, . . . " 954
Drawer Knobs, . . . " 940	
Appropriate Finishes: Brass (AZ10) Mult'r .35; Copper (CZ17) Mult'r .35; Silver (SY52) Mult'r .8	

**ITUNO**—Colonial. Fig. 59, page 958, . . . 4 pieces, including

T or Lever Handle	Drawer Pulls, . . . p. 927
Plates, . . . p. *	Key Plates, . . . " 954
Drawer Knobs, . . . " 940	
Appropriate Finishes: Bronze (BZ10) Mult'r .75; Copper (CZ17) Mult'r .75	

\* Not illustrated.



**IVRY**—French Gothic, Fig. 1 to 8, page 985, 8 pieces, including

Hinge Plates, . . . p. 851	Handle and Key Plates,
Corner Plates, . . . " 851	p. 985
Drawer Pulls, . . . " 927	Key Plates, . . p. 954

Appropriate Finishes: Brass (AZ10) Mult'r 4.3; Copper (CX22) Mult'r 4.5; Silver (SY10) Mult'r 6.

**JARNAC**—Romanesque, Figs. 1 to 6, page 980, 6 pieces, including

Hinge Plates, . . . p. 851	Key Plates, . . p. 954
Drawer Pulls, . . . " 927	

Appropriate Finishes: Copper (CX22) Mult'r 1.2; Silver (SX52) Mult'r 1.8; Iron (FX80) Mult'r 1.

**JENNICO**—Colonial. Fig. 60, page 958, . 4 pieces, including

Escutcheon Plates, . . p. *	Key Plates, . . p. 954
Drawer Pulls, . . . " 927	

Appropriate Finishes: Brass Plated (FAY22) Mult'r .25; Bronze Plated (FBZ10) Mult'r .25; Copper Plated (FCZ17 or FCX17) Mult'r .25

**KELP**—German Gothic, Fig. 1 to 13, p. 984, 18 pieces, including

Esc'n Plates, . . . p. *	Drawer Pulls, . . p. 927
Thumb-piece Plates, . " *	Drawer Knobs, . " 940
Hinge Plates, . . . " 851	Key Plates, . . " 954
Bar Sash Lifts, . . . " 984	

Appropriate Finishes: Copper (CX22) Mult'r 1.3; Iron (FX80) Mult'r 1.

**LAGRASSE**—Romanesque, Figs. 1 to 4, p. 981, 6 pieces, including

Middle Hinge Plate, . p. 852	Key Plates, . . p. 954
Drawer Pulls, . . . " 927	

Appropriate Finishes: Copper (CX22) Mult'r 1.; Silver (SX52) Mult'r 1.5; Gold (GX10) Mult'r 5.9; Iron (FX80) Mult'r .85

**LARGO**—Flemish, Fig. 104, page 937c, . 4 pieces, including

Escutcheon Plates, . . p. *	Drawer Pulls, . p. 927
Drawer Knobs, . . . " 941	Key Plates, . " 954

Appropriate Finishes: Copper (CX22) Mult'r .8; Brass (AX17) Mult'r .8

**LARISSA**—Greek, Fig. 27, page 932, . . 4 pieces, including

Escutcheon Plates, . . p. *	Drawer Pulls, . p. 927
Drawer Knobs, . . . " 941	Key Plates, . . " 954

Appropriate Finishes: Bronze (BZ10) Mult'r .85; Copper (CY22) Mult'r .9; Silver (SY22) Mult'r 1.4; Iron (FX80) Mult'r .55

\* Not illustrated.

**L**EXINGTON—Colonial, Figs. 1 to 5, p. 985, 7 pieces, including  
 Hinge Plates, . . . p. 852                      Key Plates, . . . p. 954  
 Drawer Pulls, . . . " 927  
 Appropriate Finishes : Brass (AZ10) Mult'r 1.9 ; (AY22) Mult'r 2. ;  
 Copper (CX22) Mult'r 2. ; Silver (SX52) Mult'r 2.5

**L**ODI—Italian Renaissance, Fig. 10, p. 930, 5 pieces, including  
 T or Lever H'dle Plates, p. \*                      Drawer Knobs, . p. 941  
 Drawer Pulls, . . . " 927                      Key Plates, . . . " 954  
 Appropriate Finishes : Copper (CY22) Mult'r 2.2 ; Silver (SY52)  
 Mult'r 2.9 ; Gold (GY10) Mult'r 11. ; Iron (FX80) 1.5

**L**OWELL—Colonial, Fig. 60, page 936, 3 pieces, including  
 Drawer Pulls, . . . p. 927                      Key Plates, . . . p. 954  
 Appropriate Finishes : Copper (CY22) Mult'r 1.1 ; (CX22) Mult'r 1.1 ;  
 Silver (SY52) Mult'r 1.7 ; Gold (GY10) Mult'r 7.5

**L**YNN—Colonial Figs. 17 and 19, p. 931, 13 pieces, including  
 Escutcheon Plates, . . p. \*                      Drawer Pulls, . p. 927  
 T or Lever H'dle Plates, " \*                      Key Plates, . . " 954  
 Drawer Knobs, . . . " 941  
 Appropriate Finishes : Bronze (BZ10) Mult'r .95 ; Brass (AY22)  
 Mult'r 1. ; Copper (CX22) Mult'r 1. ; Silver (SX52) Mult'r 1.5 ;  
 Gold (GX10) Mult'r 6.4 ; Iron (FX80) Mult'r .6

**L**YONS—Romanesque, Fig. 68, page 959, 14 pieces, including  
 Escutcheon Plates, . . p. \*                      Drawer Pulls, . p. 927  
 Thumb-piece Plates, . . " \*                      Drawer Knobs, . " 941  
 T-Handle Plates, . . . " \*                      Key Plates, . . . " 954  
 Hinge Plates, . . . " 852  
 Appropriate Finishes : Copper (CX22) Mult'r 1.4 ; Silver (SX52)  
 Mult'r 1.9 ; Gold (GX10) Mult'r 7.75.

**M**ADRAS—Commercial Fig. 69, page 959, 3 pieces including  
 Drawer Knobs, . . . p. 941                      Key Plates . . . p. 954  
 Drawer Pulls, . . . " 927  
 Appropriate Finish : Bronze plated (FBZ3) Mult'r .1

**M**ANCHESTER—English Ren's, Fig. 78, p. 937A, 4 pc's, including  
 Drawer Knobs, . . . p. 941                      Key Plates, . . . p. 954  
 Drawer Pulls, . . . " 927  
 Appropriate Finishes : Copper (CY22) Mult'r 2.3 ; Silver (SY52)  
 Mult'r 3.2 ; Green Bronze (BX67) Mult'r 3.2 ; Iron (FX80) Mult'r  
 1.6

, Not illustrated.

**MARATHON**—Greek, Fig. 105, page 937D, 5 pieces, including

Escutcheon Plates, . p. *	Drawer Pulls, . . . p. 927
T or Lever H'dle, " *	Key Plates, . . . " 955
Drawer Knobs, . . " 941	
Appropriate Finishes: Bronze (BZ10) Mult'r .95; Copper (CZ17) Mult'r 1.; Silver (SY52) Mult'r 1.5; Iron (FX80) Mult'r .6	

**MEDFORD**—Colonial, Fig. 75, page 959, 8 pieces, including

Escutcheon Plates . p. *	Drawer Pulls, . . . p. 927
T or Lever H'dle, . " *	Key Plates, . . . " 955
Appropriate Finishes: Brass (AZ10) Mult'r 1.3; Copper (CX22) Mult'r 1.4; Silver (SX52) Mult'r 1.9; Iron (FX80) Mult'r .8	

**MEDICI**—Italian Ren's, Fig. 76, page 959, 4 pieces, including

Drawer Pulls, . . . p. 927	Key Plates, . . . p. 955
Drawer Knobs, . . . " 941	
Appropriate Finishes: Brass (AZ15) Mult'r 2.; Copper (CX22) Mult'r 2.; Silver (SX52) Mult'r 2.8; Gold (GY10) Mult'r 10.5; Iron (FX80) Mult'r 1.5	

**MILAN**—Italian Ren's, Figs. 1 to 6, page 988, 8 pieces, including

Escutcheon Plates, . p. *	Drawer Pulls, . . . p. 927
Thumb-piece Plates, " *	Drawer Knobs, . . . " 941
Hinge Plates, . . . " 852	Key Plates, . . . " 955
Appropriate Finishes: Copper (CY22) Mult'r 2.6; Silver (SX52) Mult'r 3.2; Gold (GZ10) Mult'r 11.5; Hand-Chasing, Mult'r 1.6 additional.	

**MONACO**—Italian Ren's, Fig. 77, p. 959, . 4 pieces, including

Escutcheon Plates, p. *	Key Plates, . . . p. 955
Drawer Pulls, . . . " 927	
Appropriate Finishes: Iron, Copper Plated (FCZ17) Mult'r .25, (FCX17) Mult'r .25; Brass Plated (FAZ17) Mult'r .25, (FAX17) Mult'r .25; Bower-Barff (FX80) Mult'r .6	

**MONTAUBAN**—Romanesque, Fig. 1 to 3, p. 981, 6 pieces, including

Escutcheon Plates, . p. *	Drawer Pulls, . . . p. 927
Hinge Plates, . . . " 853	Key Plates, . . . " 955
Appropriate Finishes: Copper (CX22) Mult'r 1.1; Silver (SX52) Mult'r 1.6; Iron (FX80) Mult'r .9	

**NAVARRO**—Louis XV, Fig. 109, page 937D, 8 pieces, including

Escutcheon Plates, . p. *	Drawer Pulls, . . . p. 927
T or Lever H'dle, . " *	Key Plates, . . . p. 955
Drawer Knobs, . . . " 941	
Appropriate Finishes: Brass (AX17) Mult'r .65; Bronze (BX12) Mult'r .65; Copper (CX17) Mult'r .65	

\* Not illustrated.

**OPORTO—French Ren's, Fig. 111, p. 937D 6 pc's, including**

Escutcheon Plates, . . . p. *	Drawer Pulls, . . . p. 927
Thumb-piece Plates, . . . " *	Key Plates, . . . " 955
Drawer Knobs, . . . " 941	
Appropriate Finishes : Brass (AZ17) Mult'r .9 ; Copper (CZ17) Mult'r .9 ; Nickel (NZ17) Mult'r .9	

**ORIENTAL—Commercial, Fig. 80, p. 959, 5 pieces including**

Drawer Knobs, . . . p. 941	Key Plates . . . p. 955
Drawer Pulls, . . . p. 927	
Appropriate Finish : Bronze Plated (FBZ3) Mult'r .05	

**OSAKA—Japanese, Fig. 107, page 937D, 2 pieces, including**

Drawer Pulls, . . . p. 927	Key Plates, . . . p. 955
Appropriate Finishes : Copper (CY22) Mult'r 3. ; Royal Copper (CY25) Relief Gold Mult'r 10. ; Sage Green, (BY70) Relief Gold Mult'r 12.6 ; Gun Metal Brown, (BY62) Relief Silver Mult'r 9.7 ; Gold (GY10) Mult'r 12.6	

**PASCO—Italian Ren's, Fig. 106, p. 937D, 3 pieces, including**

Escutcheon Plates, . . . p. *	Key Plates, . . . p. 955
Drawer Pulls, . . . " 928	
Appropriate Finishes : Brass Plated (FAX17) Mult'r .25 ; Copper Plated (FCX17) Mult'r .25 ; Iron (FX80) Mult'r .6	

**PETERSHAM—Colonial, Fig. 61, page 936, 4 pieces, including**

Drawer Pulls . . . p. 928	Key Plates . . . p. 955
Drawer Knobs, . . . " 941	
Appropriate Finishes : Bronze (BZ10) Mult'r 1.3 ; Brass (AZ10) Mult'r 1.3 ; Copper (CY22) Mult'r 1.4 ; Silver (SY52) Mult'r 1.8 ; Gold (GY10) Mult'r 5.4	

**PIEDMONT—Colonial, Fig. 108, page 937D, 5 pieces, including**

Escutcheon Plates, . . . p. *	Drawer Pulls, . . . " 928
Thumb-piece Plates, . . . " *	Key Plates, . . . " 955
Drawer Knobs, . . . " 941	
Appropriate Finishes : Brass (AZ10) Mult'r .9 ; Bronze (BZ10) Mult'r .9 ; Copper (CY22) Mult'r 1. ; (CX22) Mult'r 1. ; Silver (SY52) Mult'r 1.5 ; Iron (FX80) Mult'r .7	

\*Not illustrated.

**PLYMOUTH**—Colonial, Figs. 1 to 12, p. 986, 26 pieces, including

Escutcheon Plates, . . . p. 986	Drawer Pulls, . . . p. 928
Thumb-piece Plates, . . . *	Drawer Knobs, " 941
Hinge Plates, . . . " 853	Key Plates, . . . " 955
Corner Plates, . . . " 853	

Appropriate Finishes : Brass (AZ10) Mult'r 1.1 ; (AY22) Mult'r 1.2 ; Silver (SY10) Mult'r 1.7 ; Iron (FX80) Mult'r .8

**REALMONT**—Romanesque, Fig. 86, p. 959, 4 pieces, including

T or Lever H'dle Plates, p. *	Drawer Pulls, . . . p. 928
Drawer Knobs, . . . " 941	Key Plates, . . . " 955

Appropriate Finishes : Copper (CX22) Mult'r 1.3 ; Silver (SX52) Mult'r 2. ; Iron (FX80) Mult'r 1.

**ROANOKE**—Colonial, Fig. 25, page 932, 2 pieces, including

Drawer Pulls, . . . p. 928	Key Plates . . . p. 955
----------------------------	-------------------------

Appropriate Finishes : Brass (AZ10) Mult'r 1.4 ; (AY22) Mult'r 1.5 ; Copper (CX22) Mult'r 1.5 ; Iron (FX80) mult'r 1.2

**SAARBRUCK**—German Gothic, Fig. 90, p. 959, 6 pieces, including

Esc'n Plates and Knobs, p. *	Strap Hinges, . . . p. 854
Hinge Plates, . . . " 854	Key Plates, . . . " 955

Appropriate Finishes : Copper (CX22) Mult'r 2.6 ; Silver (SX52) Mult'r 3.3 ; Gold (GX12) Mult'r 11. ; Iron (FX80) Mult'r 1.9

**SALEM**—Colonial, Figs. 37 and 39, page 933, 7 pieces, including

Escutcheon Plates, . . . p. *	Drawer Knobs, . . . p. 941
Thumb-piece Plates, . . . " *	Key Plates, . . . " 955
Drawer Pulls, . . . " 928	

Appropriate Finishes : Brass (AZ10) Mult'r 1.6 ; (AY22) Mult'r 1.7 ; Copper (CY22) Mult'r 1.7 ; (CX22) 1.7

**SAVONA**—Italian Ren's, Fig. 14, page 930, 2 pieces, including

Drawer Pulls, . . . p. 928	Key Plates, . . . p. 955
----------------------------	--------------------------

Appropriate Finishes : Copper (CX22) Mult'r .9 ; Silver (SX52) Mult'r 1.4 ; Gold (GX12) Mult'r 6.4

**SPARTA**—Colonial, Fig. 35, page 933, . 3 pieces, including

Escutcheon Plates, . . . p. *	Key Plates, . . . p. 955
Drawer Pulls, . . . " 928	

Appropriate Finishes : Bronze (BZ10) Mult'r 1.1 ; Brass (AY22) Mult'r 1.2 ; Copper (CY22) Mult'r 1.2 ; Silver (SY52) Mult'r 1.8 ; Gold (GY10) Mult'r 8.3 ; Iron (FX80) Mult'r .8

**St. CLOUD, Empire, Figs. 1 to 5, p. 988, 12 pieces, including**

Tor Lever Hdl'e Plates, . . . \*                      Drawer Pulls, . . . p. 928

Drawer Knobs, . . . " 941                      Key Plates, . . . " 955

Appropriate Finishes: Brass (AY22) Mult'r 3.25; Copper (CY22) Mult'r 3.25; Silver (SY52) Mult'r 4.2; Gold (GY12) Mult'r 12.5; Hand Chasing, Mult'r .85 additional.

**STRATFORD, Elizabethan, Fig. 1, page 929, 6 pieces, including**

Escutcheon Plates, . . . p. \*                      Drawer Pulls, . . . p. 928

T-Handle Plates, . . . " \*                      Key Plates, . . . " 955

Appropriate Finishes: Bronze (BX67) Mult'r 3.75; Copper (CX22) Mult'r 3.2; Silver (SX52) Mult'r 3.75, (SY55) Mult'r 4.5; Iron (FX80) Mult'r 2.3

**TIBER, Roman, Fig. 112, page 937D, . . . 2 pieces, including**

Drawer Pulls, . . . p. 928                      Key Plates, . . . " 955

Appropriate Finishes: Copper (CY22) Mult'r 2.2; Silver (SY52) 2.75, (SY55) Mult'r 3.5; Gold (GY10) Mult'r 9.6; Iron (FX80) Mult'r 1.6

**TOULON, Colonial, Figs. 1 to 8, p. 990, 11 pieces, including**

Hinge Plates, . . . p. 854                      Drawer Pulls, . . . " 928

Appropriate Finishes: Brass (AZ10) Mult'r 1.2; Copper (CY22) Mult'r 1.3; Silver (SY52) Mult'r 1.5; Gold (GY10) Mult'r 4.; Iron (FX80) Mult'r .9

**TOURS, French Gothic, Figs. 1 to 4, p. 989, 9 pieces, including**

Hinge Plates, . . . p. 854                      Key Plates, . . . p. 955

Drawer Pulls, . . . " 928

Appropriate Finishes: Copper (CX22) Mult'r 1.3; Silver (SX52) 1.7; Iron (FX80) Mult'r 1.

**TRAVES, Colonial, Figs. 1 to 8, page 991, 5 pieces, including**

Hinge Plates, . . . p. 854                      Drawer Pulls, . . . p. 928

Strap Hinges, . . . " 855

Appropriate Finishes: Brass (AZ10) Mult'r 1.2; Copper (CY22) Mult'r 1.3; Silver (SY52) 1.9; Gold (GY10) Mult'r 9.3; Iron (FX80) Mult'r 1.1

**TRIANON, Louis XVI, Fig. 30, page 932, 8 pieces, including**

Escutcheon Plates, . . . p. \*                      Drawer Pulls, . . . p. 928

Drawer Knobs, . . . " 941                      Key Plates, . . . p. 955

Appropriate Finishes: Brass (AY22) Mult'r 2.9; Copper (CY22) Mult'r 2.9; Silver (SY52) Mult'r 3.7, (SY55) Mult'r .3; Gold (GY10) Mult'r 11.2; Hand Chasing, Mult'r .5 additional.

\* Not illustrated.

TUNIS—Moorish, Fig. 3, page 929, . . . 7 pieces, including

Escutcheon Plates, . . p. *	Drawer Pulls, . . p. 928
Drawer Knobs, . . . " 941	Key Plates, . . " 955
Appropriate Finishes : Copper (CX22) Mult'r 2.2 ; Brass (AY22) Mult'r 2.2 ; Silver (SX52) Mult'r 2.7 ; Gold (GY10) Mult'r 9.4	

URBINO—Italian Ren's, Figs. 1 to 10, p. 987, 20 pc's, including

Escutcheon Plates, . . p. *	Drawer Pulls, . . p. 928
Hinge Plates, . . . " 855	Drawer Knobs, " 941
Corner Plates, . . . " 855	Key Plates, . . " 955
Appropriate Finishes : (CX22) Mult'r 2. ; Silver (SX52) Mult'r 2.8 ; Gold (GX10) Mult'r 11. ; Iron (FX80) Mult'r 1.4	

VALENCE—Romanesque, Figs. 1 to 4, p. 989, 11 pc's including

Escutcheon Plates, . . p. *	Drawer Knobs, p. 941
Hinge Plates, . . . " 855	Key Plates, . . " 956
Drawer Pulls, . . . " 928	
Appropriate Finishes : Copper (CX22) Mult'r 1.2 ; Silver (SX52) Mult'r 1.8 ; (SY55) Mult'r 2.4	

WEYMOUTH—Colonial, Fig. 107, p. 960, 6 pieces, including

Escutcheon Plates, . . p. *	Drawer Pulls, . . p. 928
Thumb Piece-plate, . . " *	Key Plates, . . " 956
Appropriate Finishes : Brass (AZ10) Mult'r 1.9 ; Copper (CY22) Mult'r 2. ; Silver (SY52) Mult'r 2.3 ; Gold (GY10) Mult'r 6. ; Iron (FX80) Mult'r 1.1	

WOBURN—Colonial, Fig. 110 page 937D, 6 pieces, including

Drawer Knob and Rose, p. *	Key Plates, . . p. 956
Drawer Pulls, . . . " 928	
Appropriate Finishes : Brass (AZ10) Mult'r 2.6 ; (AY22) Mult'r 2.8 ; Silver (SY52) Mult'r 3. ; Gold (GY10) Mult'r 8.5 ; Hand-chasing, Mult'r 1.4 additional.	

YORKTOWN—Colonial Fig. 110, page 960, 3 pieces, including

T or Lever H'dle Plates, p. *	Drawer Pulls, . . " 928
Thumb Piece Plates, . . " *	Key Plates, . . " 956
Appropriate Finishes : Brass (AZ10) Mult'r .9 ; Copper (CX22) Mult'r 1. ; Silver (SY52) Mult'r 1.5 ; Gold (GY10) Mult'r 4.7 ; Iron (FX80) Mult'r .7	

\*Not illustrated.

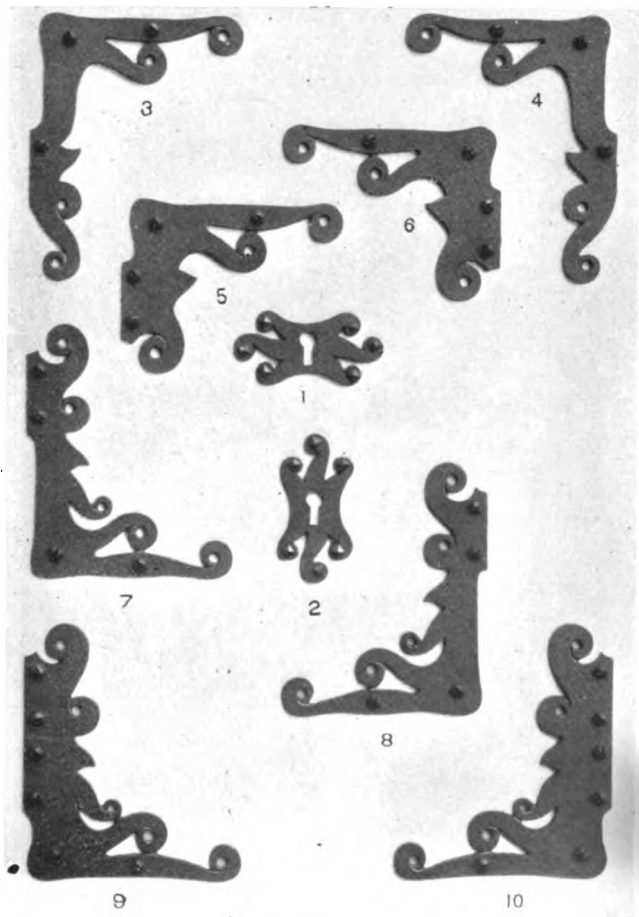

Design—Aubin. School—Colonial.

For information see page 964.

Illustrations about  $\frac{1}{4}$  size.



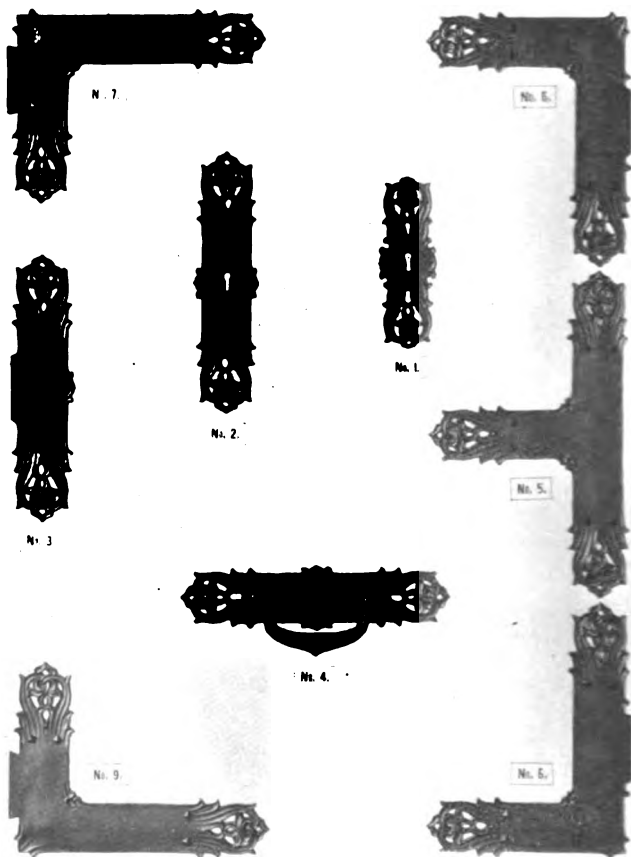

Design—Aumont. School—Romanesque.

For information see page 964.

Illustrations about  $\frac{1}{4}$  size.

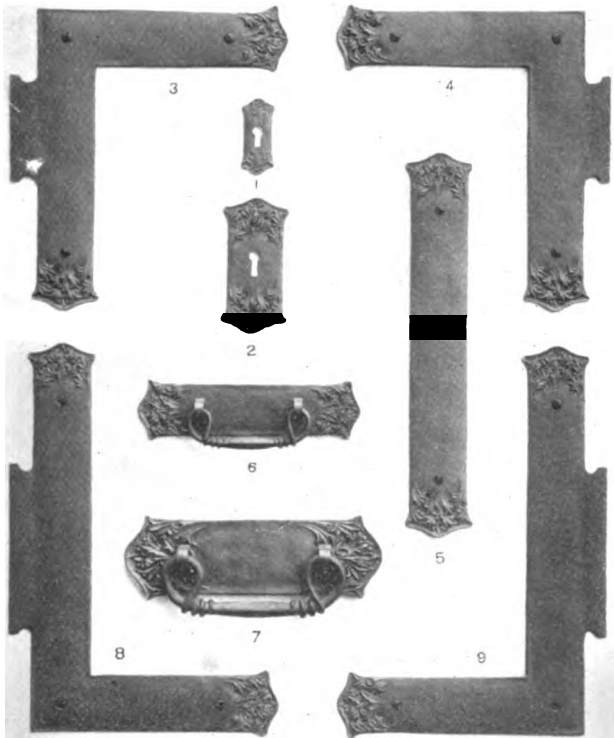

Design—Cluny. School—Romanesque.

For information see page 963.

Illustrations about  $\frac{1}{4}$  size.

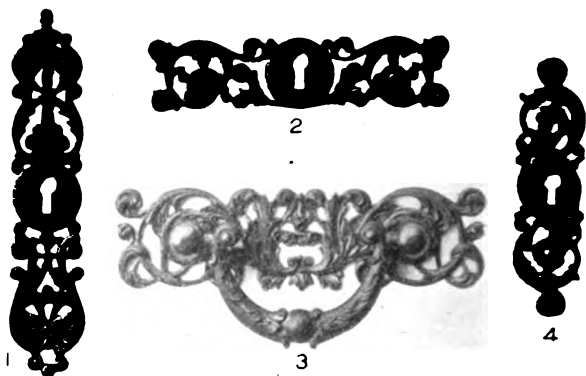

Design—Angouleme. School—French Renaissance.

For information see page 964.

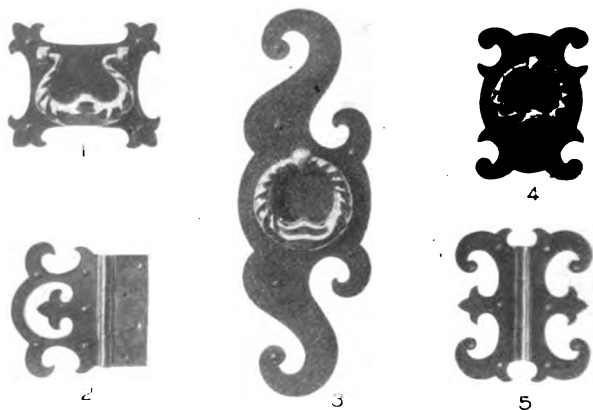

Design—Beverly. School—Colonial.

For information see page 965.

Illustrations about  $\frac{1}{2}$  size.



2



3



4

Design—Beauvoir. School—Romanesque.  
For information see page 965.



Design—Concord. School—Colonial.

For information see page 967.  
Illustrations about  $\frac{1}{2}$  size.

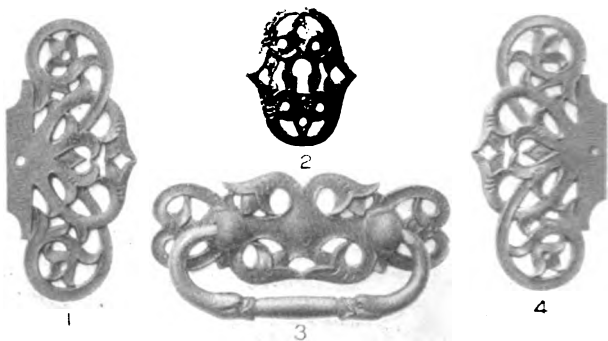

Design—Dax. School—Romanesque.

For information see page 967.

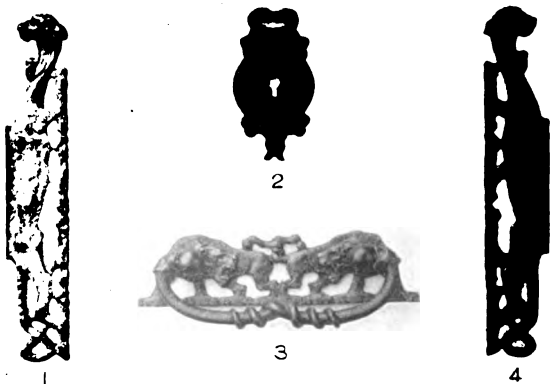

Design—Epernay. School—Gothic.

For information see page 967.

Illustrations about  $\frac{1}{4}$  size.

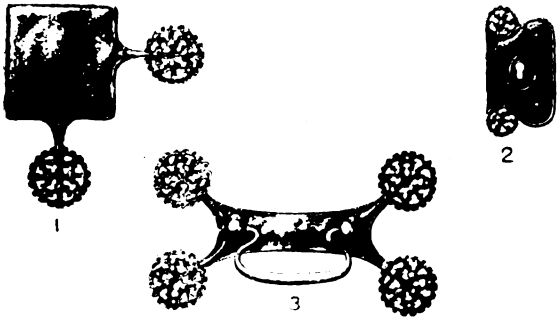

Design—Caen. School—Gothic.

For information see page 966.

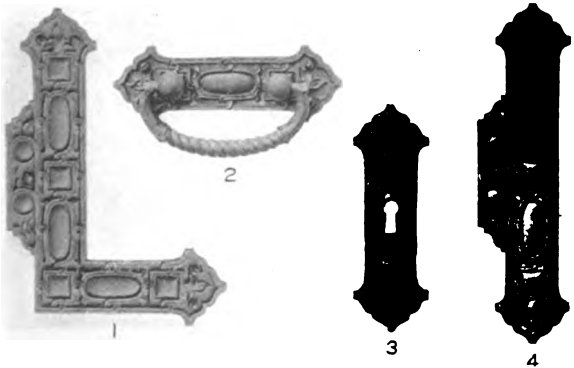

Design—Clermont. School—Romanesque.

For information see page 966.

Illustrations about  $\frac{1}{2}$  size.

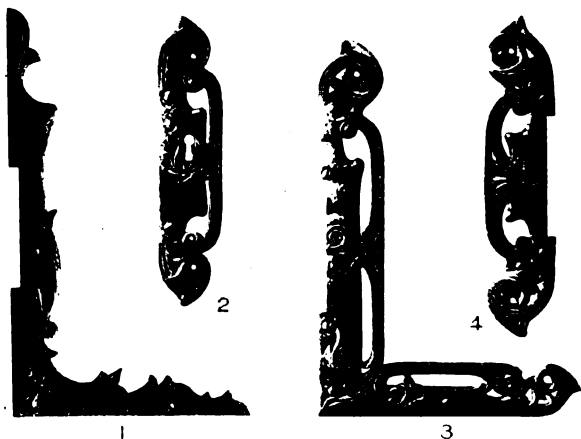

Design—Elné. School—Romanesque.

For information see page 567.

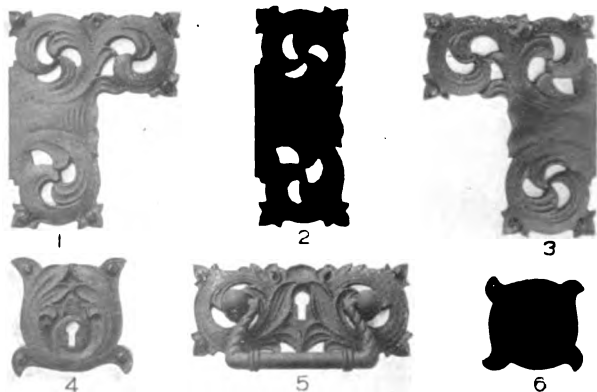

Design—Jarnac. School—Romanesque.

For information see page 970. Illustrations about  $\frac{1}{4}$  size.



2



3



4

Design—Lagrasse. School—Romanesque.

For information see page 970.



2



3



4

Design—Montauban. School—Romanesque.

For information see page 972.

Illustrations about  $\frac{1}{4}$  size.



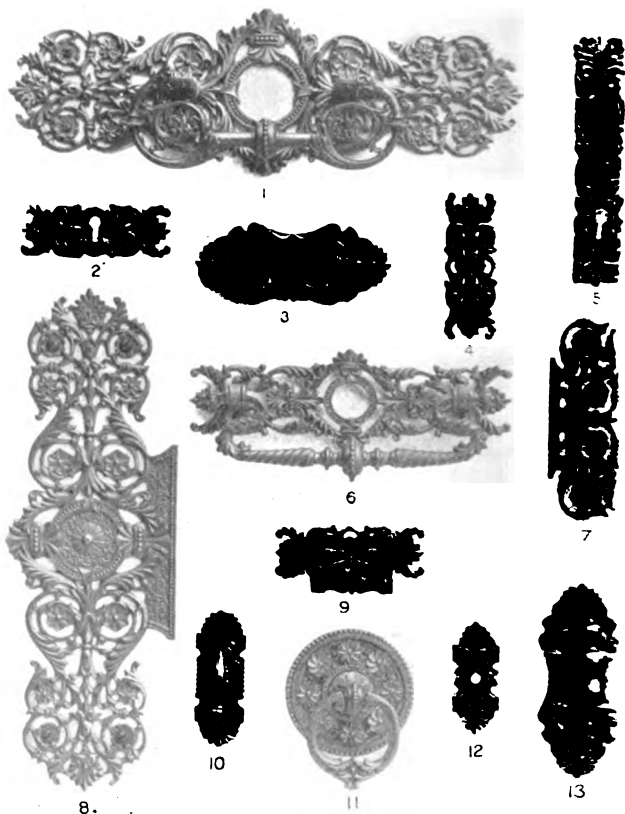

Design—Ferrara. School—Italian Renaissance.

For information see page 968.

Illustrations about  $\frac{1}{4}$  size

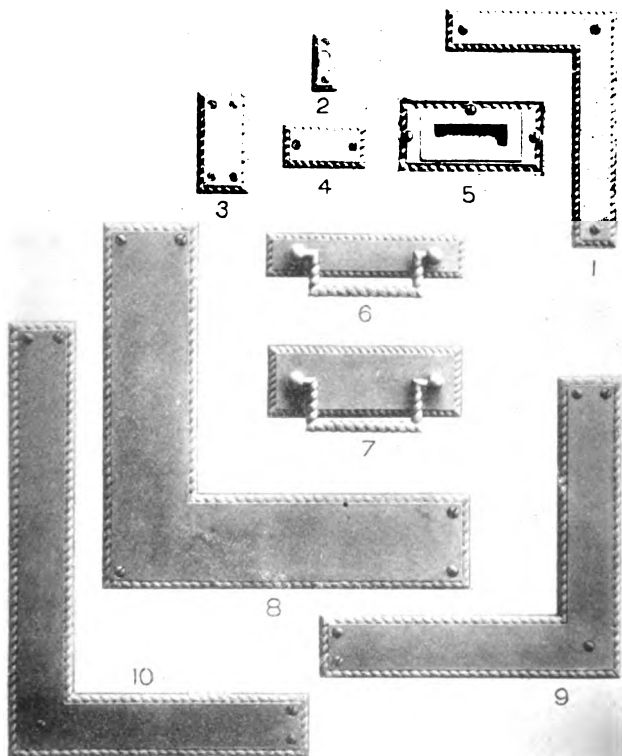

Design—Hingham. School—Colonial.

For information see page 969

Illustrations about  $\frac{1}{4}$  size

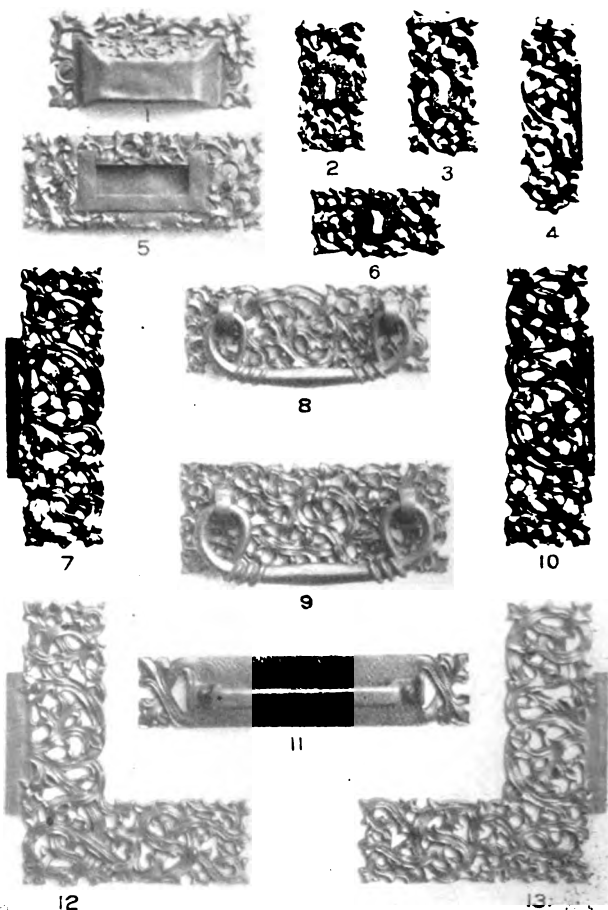

Design—Kelp. School—Gothic.

For information see page 970.  
Illustrations about  $\frac{1}{4}$  size.

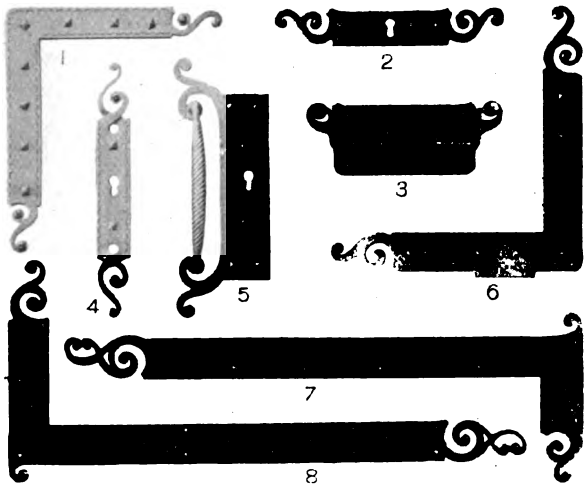

Design—Ivry. School—Gothic.  
For information see page 970.

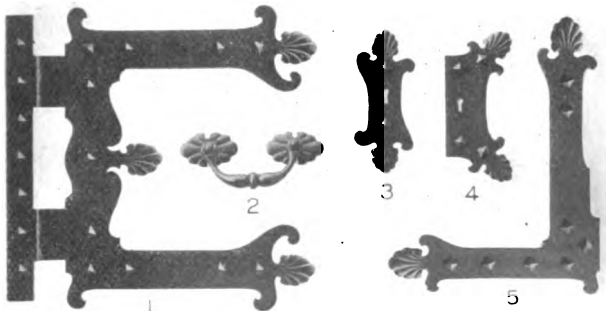

Design—Lexington. School—Colonial.  
For information see page 971. Illustrations about ¼ size.

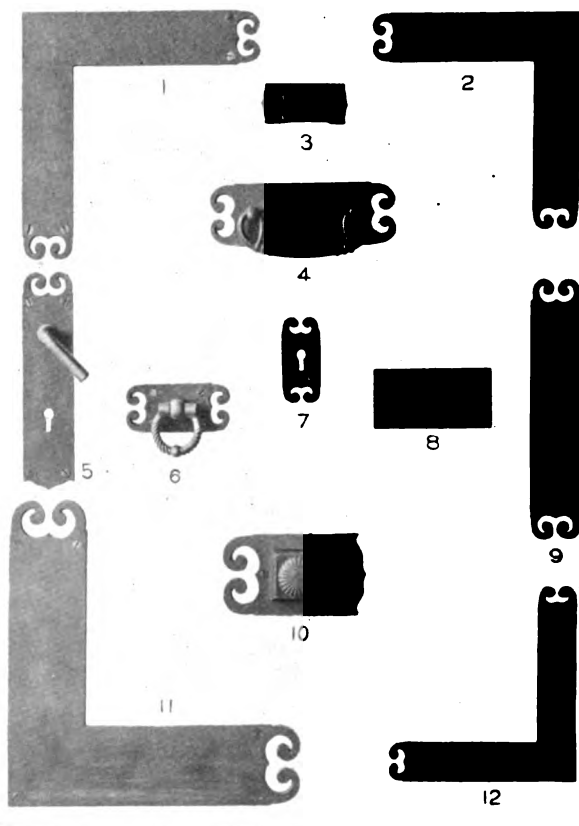

Design—Plymouth. School—Colonial.

For information see page 972B.

Illustrations about  $\frac{1}{4}$  size.

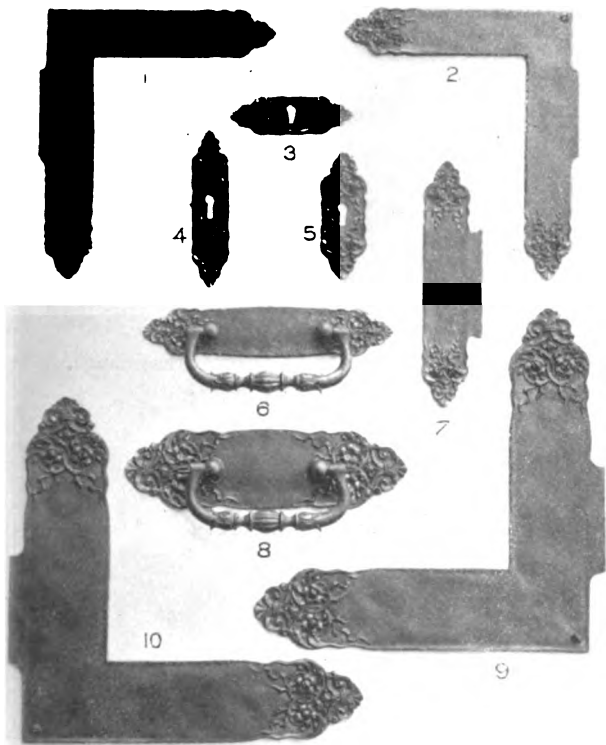

Design—Urbino. School—Italian Renaissance.

For information see page 972D.

Illustrations about  $\frac{1}{4}$  size.

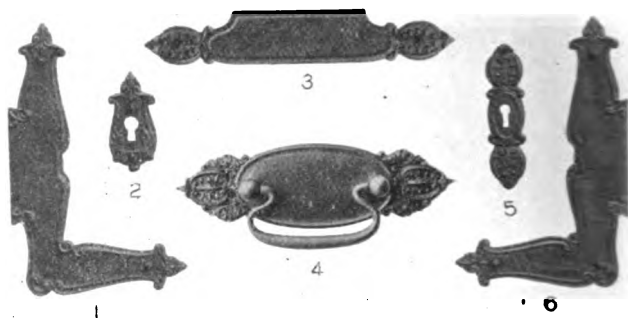

Design—Milan. School—Italian Renaissance.  
For information see page 972.

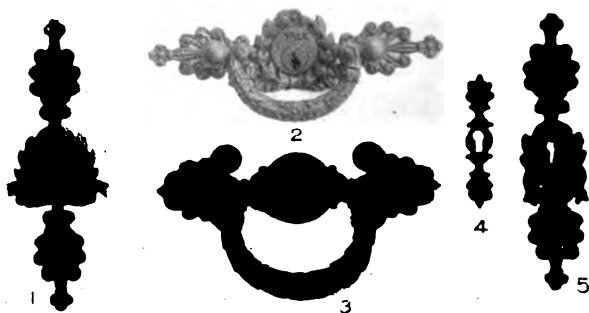

Design—St. Cloud. School—Empire.

For information see page 972C.

Illustrations about  $\frac{1}{4}$  size.



Design—Tours. School—Gothic.

For information see page 972C.

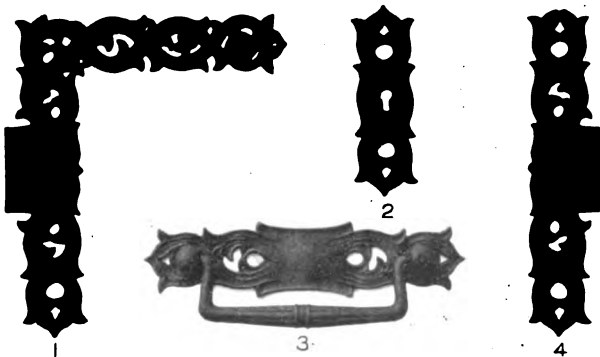

Design—Valence. School—Romanesque.

For information see page 972D.

Illustrations about  $\frac{1}{4}$  size.



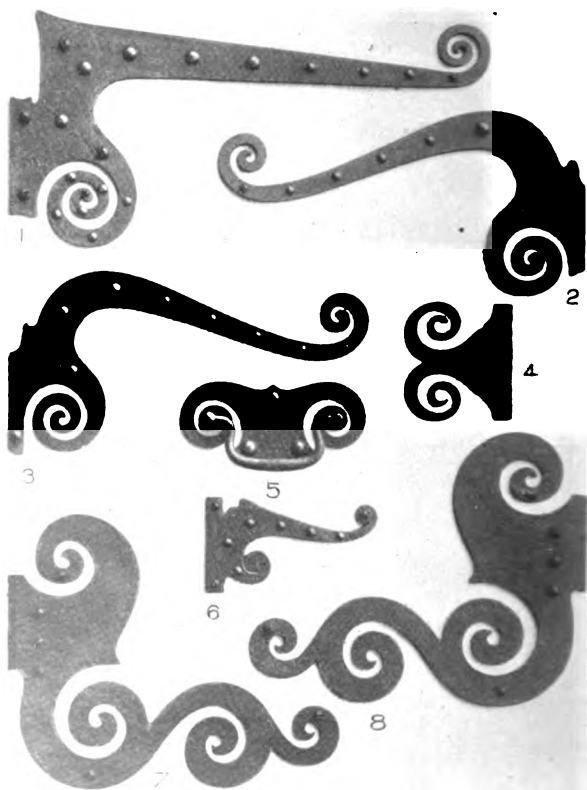

Design—Toulon. School—Colonial.

For information see page 972C.

Illustrations about  $\frac{1}{4}$  size.

Digitized by Google



Design—Traves. School—Colonial.

For information see page 972c.

Illustrations about  $\frac{1}{4}$  size.



## Part IX.

---

Specifications, Blank Forms, Etc.

## Part IX.

---

### Specifications, Blank Forms, &c.

Section.	Page.
1. Hardware Specifications, . . . . .	995
2. Forms of Specifications, . . . . .	1001
3. Forms of Contracts, . . . . .	1012
4. Examples of Specifications, . . . . .	1022
(a) A City Residence.	
(b) An Apartment House.	
(c) A Rectory and Church.	
(d) A Municipal Building.	
(e) A Leading New York Hotel.	
5. Grades and Numbers of Yale & Towne Line, . . . . .	1045

## Section 1.

---

### Hardware Specifications.

THE scope of this volume embraces no purpose of greater importance than the promotion of effective methods of selecting, specifying and purchasing the Hardware of Ornament, commonly called "Finishing Hardware."

Formerly, when Hardware involved no element of taste, still less of art, and was purely mechanical, its selection could safely be left to the contractor or builder, and specifications usually covered little more than a mere statement that the necessary hardware should be furnished and should be of good quality. The revolution accomplished in recent years, however, in the designing and making of Builders' Hardware, which has elevated it to an important place in the field of decorative art, and simultaneously created new and higher mechanical grades, has radically changed the requirements in specifications relating to this subject.

Unfortunately the scope and significance of this change are as yet not generally realized, and many hardware specifications are still drawn on the old lines, with the effect that the desired result is not realized. Doubtless this is chiefly due to want of technical information on the subject, and the purpose of what follows, combined with the information contained elsewhere in this volume, is to supply that want. *If the information and suggestions herein contained are availed of, the Architect will save himself much annoyance and disappointment, the contractor and builder will be enabled to estimate intelligently, and the client or owner will obtain what he desires and what he pays for.*

The segregation of the Hardware of Ornament from the Hardware of Construction has given rise to several distinct methods

of specification, which will be explained and discussed below. Each of them presupposes that the Hardware of Construction, such as nails, screws, sash pulleys, chains and weights, etc., and also usually sliding door hangers and rail, are all covered by the general specifications, and that only "Finishing Hardware," *i. e.* the Hardware of Ornament, inclusive of locks and fastenings, is covered by the separate hardware specifications.

The several plans most commonly availed of will be stated in their order of merit, and on pages 1001 to 1011 will be found a series of "forms" suggestive of the manner in which the subject of Builders' Hardware should be covered in specifications under each of these several plans.

#### PLAN 1. HARDWARE RESERVED.

Under this plan the Finishing Hardware is *omitted* from the general specifications, and reserved for selection by the architect or owner, under stipulation that it shall be supplied at the times and in the quantities needed by the contractor, and that the latter shall properly fit and apply it. Where this plan is adopted Form 1 (page 1001) should be introduced into the general contract.

#### PLAN 2. HARDWARE SPECIFIED DEFINITELY.

Under this plan the Finishing Hardware is *included* in the general specifications, but on the basis of a careful selection in advance by the architect or owner, and of a description more or less detailed, based on such selection, contained in the general specifications. Where this plan is adopted Form 2 (page 1002) should be introduced into the general contract. Such description may be given by either of the following methods, *viz.*:

Method A. By name of maker and by actual catalogue number, or other equivalent exact description. (See Schedule A, page 1003); or by

Method B. By general description, covering sizes, weights, metals and finishes, but omitting makers' name and list numbers. (See Schedule B, page 1007); or by

Method C. By reference to samples on file with the Architect. (See Schedule C, page 1009).

By either of these methods all important questions concerning the Finishing Hardware are removed from the field of controversy among rival contestants for the business, but without implying any restriction of competition to insure the purchase of the selected goods at the lowest market prices. Each manufacturer has established prices for his products, which are widely known to hardware dealers, and competition among the latter can safely be relied on to guard against any attempt to charge unfair prices for the goods covered by a specification of this kind.

Under this plan the Architect or his Client, or both, make the selection of hardware, deliberately and carefully, as its importance justifies, precisely as all other important details of material and of permanent decoration are necessarily determined in advance; whereas, when the selection of the hardware is deferred it is apt to be left until the last minute, and then is made under pressure and without due opportunity for thorough investigation and study. Being thus settled in advance, the architect is relieved from the annoyance he is otherwise inevitably subjected to from rival dealers or manufacturers, each importuning him for attention, and also from all trouble arising from differences between the views of the contractor and those of the architect as to what constitutes "standard hardware of approved design," as is liable to be the case where the hardware is included in the general contract and left to selection or purchase by the contractor. Moreover, in this way both the architect and contractor, as well as the owner, have definite knowledge, in advance, of the cost of hardware, and can include this item



in the summary of total cost with certainty that it is correct and final.

This plan has been adopted during recent years by many leading architects, and with steadily increasing favor. The fact that it had its origin with such members of the profession and is now used by them to the exclusion of other plans is the best evidence of its intrinsic merit. Where it is adopted the specifications for hardware should follow the lines suggested in Form 2 and Schedules A, B or C (pages 1002 to 1010), according to which of the *methods* A, B or C, above referred to, is selected.

#### PLAN 3. HARDWARE COVERED BY FIXED ALLOWANCE.

Under this plan Finishing Hardware is *included* in the general specification, as under Plan 2, but on a different basis, which consists in specifying a *fixed sum* to be allowed by the contractor for the purchase of the Finishing Hardware, the architect or owner reserving the right of selection within this limit, and of exceeding it on condition of paying the excess cost.

This plan is distinctly inferior to either of the two preceding, and has little to commend it except where conditions preclude the definite selection of hardware at the time and under the conditions which are essential to the best result. It may be easier, at the moment, simply to say that so many dollars shall be allowed for hardware than to select or specify it, but sooner or later it must be selected, and the selection will usually be made with greater care and discrimination if done in advance than if done under the pressure which nearly always exists as the work of building approaches completion. Moreover, as much, if not all, of the Finishing Hardware usually has to be *made to order* its quality will distinctly be better if ample time be given in which to produce it, than if it is made in haste because, for any reason, it has not been ordered until nearly or quite the time

when it is wanted. Delay in ordering is also liable to result in delay in delivery, and this in turn may interfere with the finishing of cabinet work and so retard the completion of the entire building. On *all* grounds it is better that the selection of the hardware should be made at an early date.

If, however, circumstances compel resort to the method of a "fixed allowance" its objections will be diminished by the architect or owner making a *preliminary selection* of designs and finishes, and then obtaining from the manufacturer or dealer a preliminary estimate, based on a schedule of quantities compiled from the architect's plans, which estimate, while not final, will at least approximately indicate the allowance which reasonably should be made for the Finishing Hardware. While the kinds and quantities of hardware finally selected may not conform exactly to this preliminary estimate, the latter constitutes a safer basis for the "fixed allowance" than any sum arrived at by arbitrary determination or guess work.

Where this plan is adopted Form 3 (see page 1010) may be followed in framing the specification for hardware.

#### PLAN 4. HARDWARE COVERED BY ALLOWANCE PER OPENING.

Under this plan (commonly known as the "Boston Plan"), as under Plan 3, the Finishing Hardware is *included* in the general specification, but on a basis which consists in specifying a fixed sum *per opening* to be allowed by the contractor for the purchase of the Finishing Hardware, and in leaving *to the contractor* the selection of hardware within the limits of price thus indicated.

Where used *in the above form* this plan is the crudest and most unsatisfactory of any in use. Formerly it was much in vogue in Boston, but fortunately it is now decreasing in use there

and is nearly obsolete elsewhere. By leaving the selection of Finishing Hardware to the contractor it opens the door to endless controversies, and rarely produces results which are satisfactory either to the architect or his client. In principle it is as illogical as to specify a price at which the contractor is to furnish the completed building, leaving all details of its construction and finish to his decision. The plan is unfair to the contractor as well as to the owner, and is so unsuitable for its purpose that *no suggestion is offered as to the form of specification required where it is adopted.*

Where, however, under this plan the *right of selection* is reserved to the architect or owner, within the limit of a stated cost per opening, this plan becomes equivalent to Plan 3, with the allowance for hardware stated "by opening" instead of "in lump." In most cases it is better to state the allowance in lump rather than by opening, as in this way greater flexibility is afforded for the exercise of taste or judgment by the architect or owner in the selection of the Finishing Hardware when finally made.

In Section 2 immediately following will be found Forms of Specifications suitable for use under each of the "Plans" above described.

## Section 2.

---

### Forms of Specifications.

**T**HE preceding Section contains a discussion of the subject of **HARDWARE SPECIFICATIONS**, and a description of the several methods of specifying Hardware which are most commonly employed. The Standard Forms for Specifications given below are framed in harmony with the statements contained in the foregoing discussion of this subject, and cover each of the several Plans therein described. Standard Forms for *Contracts* will be found in Section 3, page 1012.

#### FORM 1.

FOR USE WHERE PLAN 1 IS ADOPTED—**HARDWARE RESERVED.**

(See page 996 for Explanation of "Plan 1.")

**THE ROUGH HARDWARE**, such as nails, screws, sash pulleys, sash chains (or sash cord), sash weights, anchors, screw bolts, sliding door hangers, etc., shall be furnished by the *contractor*, and at his own cost, as specified in connection with the carpenter work or otherwise; all of which shall be of standard quality approved by the architect.

**THE FINISHING HARDWARE**, including butts, locks and their trim, and the other fastenings and metal work for doors, windows, closets and cabinets, will be furnished by the *owner*, delivered at the building in the quantities and at the times reasonably needed by the contractor; the contractor to be responsible therefor after delivery and until completion of the building. All Finishing Hardware is to be properly fitted and applied in place by the contractor, under the direction and to the satisfaction of the architect. Door knobs after being fitted in place, are to be kept covered with cloth until the building is completed, to protect them from injury by handling, and all keys are to be cared for by the contractor until the building is completed and then to be delivered to the owner, either in their locks or with tags attached to indicate where they belong.

The contractor shall furnish the manufacturer or dealer from whom the Finishing Hardware is purchased with all information as to the details of wood work which may be necessary or desirable to enable the party furnishing the

Finishing Hardware to understand the requirements and to harmonize the Hardware with the Cabinet work to such extent as may be necessary and feasible, and, where interferences are discovered, to have them adjusted before the Hardware is supplied.

### FORM 2.

FOR USE WHERE PLAN 2 IS ADOPTED—HARDWARE SPECIFIED DEFINITELY.

(See page 996 for Explanation of "Plan 2.")

THE ROUGH HARDWARE, such as nails, screws, sash pulleys, sash chains, (or sash cord), sash weights, anchors, screw bolts, sliding door hangers, etc., shall be furnished by the contractor, and at his own cost, as specified in connection with the carpenter work or otherwise; all of which shall be of standard quality approved by the architect.

THE FINISHING HARDWARE, including locks and their trim, butts, door bolts, window and shutter fastenings, catches, hooks, etc., including therewith knobs, escutcheon plates and other metal trim for doors, windows, closets and cabinet work, together with all necessary screws therefor, shall also be furnished by the contractor [for the wood work?] in conformity with

Schedule A, page 1003, (or B, page 1007; or C, page 1009); attached to and forming part of this specification, in which is set forth the character of the Finishing Hardware to be used in the several parts of the building. The quantities of such hardware required will be ascertained by the contractor from the plans and specifications, and shall be such as to provide the proper fastenings and trim for all doors, windows, closets and cabinet work, in conformity with the intent of the plans and specifications.

The contractor shall take charge of, and be responsible for, such hardware when and as delivered at the building by the manufacturer or dealer by whom supplied. At the proper time the contractor, in a suitable and workmanlike manner, shall fit and apply the hardware in place, to the satisfaction of the architect and subject to his approval, being responsible for its proper care and protection until the building is completed and is accepted by the owner.

The contractor shall furnish the manufacturer or dealer, from whom the Finishing Hardware is purchased, with all information as to the details of wood work which may be necessary or desirable to enable the party furnishing the Finishing Hardware to understand the requirements and to harmonize the hardware with the Cabinet work to such extent as may be necessary and feasible, or, where interferences are discovered, to have them adjusted before the hardware is made.

The decision of the architect concerning any and all disputes arising under

this contract relating to the Finishing Hardware, or its application, shall be final and binding upon the contractor.

### SCHEDULE A.

(For use with Form 2, page 1002).

The Finishing Hardware required in the building shall conform absolutely, as to maker, catalogue number, design, size, metal, finish and quality, to the following specifications.

*[Then should follow a full and accurate description of the hardware selected, which may be specified by rooms, by opening, by "combination," or in such other way as will best meet the conditions in each case. A few examples are given below.]*

Unless otherwise specified the hardware shall all be the product of The Yale & Towne Mfg. Co., and in such case the catalogue numbers and finish symbols herein used are those used in the catalogue of said Company, [and also in this volume]. When other goods are called for they will be indicated by the name, catalogue numbers and finish symbols of the maker whose goods are to be used.

**DESIGNS, METALS AND FINISHES.**—These shall be as follows for all of the Finishing Hardware in each of the several parts of the building, except when otherwise specified herein or where otherwise directed or authorized by the architect, viz:

Front and vestibule doors, Amherst design, polished brass, AZ10.

Halls, first and second floors, Amherst design, polished brass, AZ10; third floor, plain, polished brass, AZ10.

Parlor and music room, Fairfax design, gold plated, GZ10.

Dining-room, Fairfax design, glass knobs No. G67 with rose, key-plates No. 821, all polished brass, AZ10.

Library and Den, Brabant or Stratford design, as decided by the architect, verde antique, BX67.

Bedrooms, second and third floors, Weymouth design, glass knobs No. G66 with rose, key-plate No. 821, all dull brass, AY22.

Bathrooms; plain bronze, glass knobs No. G86 with rose, nickel plate, NZ10.

Attic, basement and service portions; plain, steel bower-barff, SX80; except pantry, kitchen and laundry, which shall be plain bronze, polished, BZ10.

**BUTTS.**—All butts for entrance, room and closet doors, except in attic, basement and other service portions of house, shall be of the No. 750 loose-

pin type, with five knuckles, "hold-fast" pin, and self-lubricating steel washers, 5 inches high and wide enough to clear the door trim. The metal and finish of butts shall correspond with those of the other hardware of the room in which the knuckles of the butts are exposed.

Those for doors in attic, basement and service portions of house shall be of the Stanley Works No. 239 type,  $4\frac{1}{2}$  inch size, steel, bronze plated and polished, except where otherwise specified.

Doors 7 feet and less in height to have two butts, and doors over 7 feet to have three butts, to each leaf.

Doors for all dressers, bookcases, china, linen, medicine and cut-out closets, etc., to have butts of appropriate size, conforming in metal and finish to the other hardware of the respective rooms in which located.

**BOLTS.**—Those for the double entrance doors shall be of the flush lever extension type, No. 283 or 383, of length to admit of easy reach, and of metal and finish to match the lock trim. Those for double wardrobe doors to be No. 280, in plain bronze.

For French windows in parlor the No. 883 espagnolette bolt shall be used, and for the casement windows in library the No. 893 cremorne bolt, each to correspond in design, metal and finish with the other hardware of the room in which used.

**Locks.**—Front entrance shall have Yale cylinder lock No. 750 on outer or front door, and No. 790 on inner or vestibule door, with keys alike to pass both locks. Side and rear entrance doors shall also have No. 750 locks, each to different keys, and also master-keyed to same key as front entrance.

Hall doors in main parts of house to have Standard locks No. 1500, keys all alike.

Sliding doors, if double, to have No. 1706 lock, and, if single, No. 1706  $\frac{1}{2}$ .

All bed-room doors to halls shall have either a No. 1402 lock (3 bolts), or else a No. 1500 lock (2 bolts) and a mortise thumb bolt No. 1050, as directed by the architect.

Communicating doors, between rooms, shall have a No. 1525 or No. P2400 lock, 3 bolts, with thumb-piece on each side.

Bath and toilet-room doors shall have a No. 1505 lock, 2 bolt, with thumb-piece on inside.

All closet doors shall have a 2-bolt lock No. 1500, except in service portions, where No. P3310 may be used, and all shall be trimmed on both

side.

Secret doors shall have a special secret latch, operated by mechanical push button in jamb, of same color as jamb, with knob on one side, if called for.

Doors in all service portions of the house, including attic and basement, shall have 2-bolt lock No. P2918 $\frac{3}{4}$ , and also, in the case of doors from halls to bedrooms or to bathrooms, either a mortise bolt No. 1060 or else a 3-bolt lock No. P5918 $\frac{3}{4}$ .

All doors to dressers, cupboards, linen and medicine closets, bookcases, cut-out boxes, secret panels, etc., shall have brass cabinet locks of appropriate size and style, selected or approved by the architect, either cylinder or lever tumbler as he may direct.

The doors to store room and wine closet shall each have a Yale night latch No. 66 or No. 42, each with different keys and master-keyed to same key as front entrance. Also a Knob latch No. 1000, if called for.

Each door separating the main portion of house from the service portion shall have, in addition to a lock No. 1500, a mortise bolt No. 1050, with thumb-piece on main side.

The entrance and closet doors of each room shall have locks with keys alike.

The trim of each lock shall correspond in metal, design and finish, on each side, with the hardware specified or selected for the room or hall in which it is exposed.

**KNOBBS.**—All locks shall be fitted with "Triplex" screwless knobs and spindles. Knobs for entrance doors shall be 2 $\frac{1}{2}$  inch size, and for all other doors 2 $\frac{1}{4}$  inch, and all shall be of the "bracket-bearing" type.

All knobs for main floor shall be of solid bronze or brass; for upper floors of cut glass, and for service portions of house of bronze metal W55 $\frac{1}{2}$  and W56, or steel Bower-Barffed S55 $\frac{1}{2}$  and S56. The metal, design and finish of knob plates and roses, and of the knobs themselves when of metal, shall correspond with those of the hardware specified for the respective rooms in which used.

**ESCUTCHEON PLATES.**—These shall be of standard sizes obtainable in the designs selected, but of not less than the following lengths, unless so authorized by the architect, viz :

For front and vestibule doors,	. . .	10 inches.
“ other entrance doors,	. . .	9 “
“ main floor doors,	. . .	8 “
“ upper floor doors,	. . .	7 “
“ service portion doors,	. . .	6 “



The front and vestibule double doors shall have double trim. All closet doors shall have knobs and plates on both sides.

All escutcheon plates and knob-roses shall have No. 0 thimbles, to fit knobs of the "bracket-bearing" type.

**SASH FASTS.**—Those for main floor and basement shall be of the No. 1376 burglar-proof type; those for upper floors No. 1372; and those for attic No. S2400; all to correspond in metal and finish with hardware of room in which used.

**SASH LIFTS.**—Those for main and upper floors to be of the No. 1349 flush type, of same design as other hardware in the room in which used; those for service portions of house, including attic and basement, to be of the No. 91 hook type,  $1\frac{1}{2}$  inch wide, all to correspond in metal and finish with the other hardware. Sash sockets to be provided where needed, and to be of No. 410 type and of appropriate metal.

**STOP BEAD SCREWS AND WASHERS.**—To be provided for all windows, except in basement and attic, to be of No. 9 flat head screw and washer, and in quantity sufficient to admit of a spacing not to exceed 10 inches.

**CASEMENT ADJUSTERS.**—Those to be of No. 1395 type, of plain bronze, polished, and of length to permit sash to be opened to a right angle.

**INSIDE SHUTTER TRIM.**—Butts to be of proper kind and size to hang shutters as shown on drawings, and of plain bronze, polished. Knobs to be  $1\frac{1}{4}$  inch size, No. 1021, of plain bronze or ornamental, as selected by architect. Shutter bars to be of No. 1384 type, plain bronze, polished.

**COAT AND HAT HOOKS.**—These shall be provided for all closets, and in quantity sufficient to allow one hook for each 9 inches of length of rails provided for hooks. Those in main hall coat closet to be No. 513; those in bedroom closets to be No. 513; those in bath-rooms to be one-half No. 513, and one-half No. 1606; and those in all service portions to be No. 2513; all to correspond in metal and finish with the other hardware.

**PUSH BUTTONS.**—These shall be furnished by the contractor for the electrical work, and shall correspond in design, metal and finish, with the other hardware of the door to which adjacent.

**TRANSOM RODS.**—These shall be of  $\frac{5}{8}$ -inch size in main portions of house and  $\frac{1}{4}$ -inch size in service portions. They shall have an automatic grip, and shall be of length to bring the grip within 5 feet of the floor. They shall correspond in metal and finish with the other hardware of room in which used.

**DOOR CHECKS.**—Blount Liquid Door Checks made by the Yale & Towne

Mfg. Co. shall be furnished for the places, of the sizes and in the finishes specified below, viz.:

For each vestibule storm door size No. 4, solid bronze, polished. For door from butler's pantry to dining room size No. 3, solid bronze, polished. For door from kitchen to hall size No. 3, iron, gold bronzed.

**GENERAL.**—There shall also be provided all other Finishing Hardware, usually furnished and reasonably required for the proper completion of the building in conformity with the intent of the plans and specifications, all of which shall conform in quality, design and finish to the other hardware herein more specifically described, and to the cabinet and carpenter work as shown by the plans and details, and as selected or approved by the architect.

### SCHEDULE B.

(For use with Form 2, page 1002.)

The Finishing Hardware required in the building shall conform absolutely as to size, metal, finish and quality, and as to design where indicated, to the following specifications.

*[Then should follow a full and accurate description of the hardware, by items, "combinations" or rooms, the important details of each article being so fully specified as to secure the desired kind and quality and to exclude inferior and cheaper substitutes. A few examples are given below.]*

**DESIGNS.**—These shall be subject to selection or approval by the architect from among the stock patterns of manufacturers; those for the hardware for entrance doors and main floor to be of the best grade, and those for the upper floors of medium grades. The hardware for all service portions of house to be of plain steel, bronze plated.

**METALS AND FINISHES.**—The hardware for all main portions of the house to be of solid cast bronze or brass, gold plated for parlor and library, silver plated for dining room, and elsewhere in the natural color, polished. In the service portions to be bronze metal, polished.

**BUTTS.**—All butts for entrance, room and closet doors, except when otherwise specified, shall be of solid bronze (or brass), of the loose-pin five knuckle type, with ball tips, self-lubricating double steel bushings and "hold-fast" pins, and of such thickness that a pair of butts of each size shall weigh not less than as follows, other sizes to weigh proportionately, viz.:

4	× 4	inch butts,	2 lbs. 6 oz. per pair,	without screws.
4	½ × 4	½ “ “	3 lbs. 2 oz. “ “	“ “
5	× 5	“ “	4 lbs. 3 oz. “ “	“ “
6	× 6	“ “	6 lbs. 6 oz. “ “	“ “

Each door or leaf using these butts shall have three butts for doors over 7 feet in height, and two butts for doors 7 feet or less in height. The metal and finish of the butts shall correspond with the hardware of the room in which the knuckles of the butts are exposed.

**BOLTS.**—Door bolts where needed shall have a “lever action,” shall be of length to afford an easy reach, and shall conform in metal and finish to the other hardware.

**LOCKS.**—The locks for all entrance doors shall be of the cylinder type, with night work, ⅜-inch swivel spindles and not less than 6 inches in height. Those for doors on main floor shall be not less than 4 ¼ inches in height, with two bolts, not less than three lever tumblers, solid steel keys, and “standard” easy spring action. Those for bedroom doors shall be not less than 5 inches in height, with three bolts, not less than three lever tumblers, solid steel keys, and “standard” easy spring action. Those for all service portions of the house shall be not less than 3 ½ inches in height with three lever tumblers and solid steel keys. Those for store-room and wine cellar shall be mortise cylinder night latches. [*And so on until all varieties of locks required are specified.*]

**KNOBS.**—Where bronze (or brass) knobs are called for they shall be of solid metal, the top in one piece, without joint, and shall be provided with a device, of established repute, approved by the architect, for attaching them securely to the spindle without resort to any screw-holes in the latter. The knob-shank and its thimble shall be of the “bracket-bearing” type, that is, with a turned bearing supporting the knob close to its head.

**ESCUTCHEON PLATES.**—These shall be not less than 10 inches long for entrance doors, 9 inches for doors on main floor, 8 inches for bedroom and closet doors, and 6 inches for doors in service portion. They shall be of heavy cast metal, with bracket-bearings for knobs, and shall match other hardware in design, metal and finish.

**SASH FASTS.**—These shall be of burglar-proof construction, and shall operate effectively to draw the two sashes together and to force them vertically against the top and bottom of window frame. They shall be of heavy construction and shall match the other hardware in metal and finish.

**SASH LIFTS.**—These shall be of the flush type in all main portions of the

house, with cup not less than  $2\frac{1}{2}$  inches long, and, in the service portions, of the hook type, not less than  $1\frac{1}{4}$  inches wide.

**TRANSOM RODS.**—These shall be of  $\frac{5}{16}$ -inch size in main portions of house and  $\frac{1}{4}$ -inch size in service portions. They shall have an automatic grip, and shall be of length to bring the grip within 5 feet of the floor. They shall correspond in metal and finish with the other hardware of room in which used.

**DOOR CHECKS.**—These, where called for, shall be of the liquid type, of real bronze, polished, in main portions of house, and of iron, gold bronzed, in service portions, and of medium or large size, according to conditions.

**GENERAL.**—All other hardware required shall be of standard quality and sizes, conforming in metal and finish to the other hardware of room in which used, and subject to selection or approval by the architect.

**NOTE.**—The foregoing is merely an outline, is suggestive of the manner in which a schedule of this kind should be compiled, but is by no means complete. The proper method of framing such a schedule is to select carefully a *complete line* of hardware, made by one or several manufacturers, of satisfactory kind and quality, and then to write a description of each group of articles which shall cover all of the important features but omitting makers' names and numbers.

### SCHEDULE C.

(For use with Form 2, page 1002.)

The Finishing Hardware required in the building shall conform absolutely, as to maker, catalogue number, design, size, metal, finish and quality, to the samples already selected and now *on file* in the office of the architect, where they may be examined by the contractor, and where he can obtain full information as to the doors, windows, etc., on which each article shown by the samples, is to be used. These samples will remain on file in the architect's office until the completion of the building, and shall constitute the *standard* to which all Finishing Hardware used in the building must conform in every respect. Upon the completion of the building, and before its acceptance, the architect will cause an inspection to be made to ascertain if the hardware actually used conforms in all respects to the samples on file, and also if it has been properly applied and is in good condition: the acceptance of the hardware to be conditioned on a satisfactory result of this inspection, and the decision of the architect to be final and binding upon the contractor as to all questions relating to the hardware so furnished.

The contractor will be furnished with full plans and specifications of the building, and with any additional information needed to enable him to ascertain the quantities of hardware of each kind required under this specification for the complete equipment of the building, and will be responsible for the furnishing of the quantities so required.

**NOTE.**—This method implies that a complete selection of the hardware be made in advance, and that arrangement be made with a manufacturer or dealer whereby the official set of samples will be supplied to the architect and be properly tagged for convenient use and reference. When so supplied they should be kept under lock and key until the contract is completed.

### FORM 3.

**FOR USE WHERE PLAN 3 IS ADOPTED—HARDWARE COVERED BY FIRED ALLOWANCE.**

*(See page 998 for Explanation of "Plan 3.")*

**THE ROUGH HARDWARE.**—The same form of specification for this to be used as indicated under Form 2, page 1002.

**THE FINISHING HARDWARE.**—The Contractor [for the Cabinet work?] shall reserve the sum of \$—— to be expended, under the direction of the architect, for the Finishing Hardware, including therein all locks and their trim, butt, door bolts, window and shutter fastenings, catches, hooks, etc., and including therewith knobs, escutcheon plates and other metal trim for doors, windows, closets and cabinet work, together with all necessary screws therefor, in such quantities as may properly be required for the complete equipment of the building in accordance with the intent of the plans and specifications, and to the satisfaction of the architect. The contractor shall fit and apply in place all of said Finishing Hardware, in a neat and workmanlike manner, to the satisfaction of the architect and subject to his approval, and shall be responsible for its proper care and protection until the building is completed and accepted by the owner.

All of the Finishing Hardware so required shall be selected or approved by the architect, and no such hardware shall be used, save by the consent in writing thereto of the architect, which is not the product of one of the following manufacturers, viz.: A. B. & Co., B. C. & Co., or C. D. & Co.

The Finishing Hardware shall all be of the best kind and quality obtainable within the limit of the allowance above stated, a proportionate deduction from the above contract price to be made if the actual cost, at fair market prices, of the hardware selected and finally approved by the architect (with ten per cent. added to such cost), does not equal the above stated allowance; the right being hereby specifically reserved to the owner of selecting and using Finishing Hardware of better quality or higher cost than herein contemplated upon condition that, in such case, the owner shall pay to the contractor such additional amount as, with the sum stated above, shall equal the actual cost, at fair market prices, of the Finishing Hardware so selected, with ten per cent. added to such cost to cover the contractor's work in applying the hardware. The contractor shall furnish the manufacturer or dealer, from whom the Finishing Hardware is purchased, with all information as to the details of woodwork which may be necessary or desirable to enable the party furnishing the Finishing Hardware to understand the requirements and to harmonize the hardware with the Cabinet work to such extent as may be necessary and feasible, or, where interferences are discovered, to have them adjusted before the hardware is made.

## Section 3.

---

### Standard Forms of Contract for Builders' Hardware.

**T**HE preceding Sections of this Part have indicated the Standard Forms which are recommended for *Specifications* for Hardware. For the purpose of recording a *Contract* for furnishing hardware one of the following Forms may be availed of :

#### THE UNIFORM CONTRACT.

This is the form of contract for building operations adopted and recommended for general use by the American Institute of Architects and the National Association of Builders, of which the Inland Architect Press, Chicago, Ill., is the licensee for exclusive publication. It can be obtained from most dealers in architects' supplies. It is carefully drawn to cover all legal requirements, and, by inserting the necessary descriptive matter, can be utilized to embody a contract for furnishing hardware under any of the plans previously described. Its text is as follows, viz :

*The Uniform Contract*, adopted and recommended for general use by the American Institute of Architects and the National Association of Builders

*THIS AGREEMENT*, made the . . . . . day of . . . . . 19 . . . by and between . . . . . party of the first part (hereinafter designated the Contractor), and . . . . . party of the second part (hereinafter designated the Owner),

*Witnesseth* that the Contractor, in consideration of the agreements herein made by the Owner, agree with the said Owner, as follows :

ARTICLE I. The Contractor shall and will provide all the materials and perform all the work for the . . . . . as shown on the drawings and described in the specifications prepared by . . . . . Architect, which drawings and specifications are identified by the signatures of the parties hereto, and become hereby a part of this contract.

ART. II. It is understood and agreed by and between the parties hereto that the work included in this contract is to be done under the direction of the said Architect, and that . . . . . decision as to the true construction and meaning of the drawings and specifications shall be final. It is also understood and agreed by and between the parties hereto that such additional drawings and explanations as may be necessary to detail and illustrate the work to be done are to be furnished by said Architect, and they agree to conform to and abide by the same so far as they may be consistent with the purpose and intent of the original drawings and specifications referred to in Art I.

It is further understood and agreed by the parties hereto that any and all drawings and specifications prepared for the purposes of this contract by the said Architect are and remain . . . . . property, and that all charges for the use of the same, and for the services of said Architect are to be paid by the said Owner.

ART. III. No alterations shall be made in the work except upon written order of the Architect; the amount to be paid by the Owner or allowed by the Contractor by virtue of such alterations to be stated in said order. Should the Owner and Contractor not agree as to amount to be paid or allowed, the work shall go on under the order required above, and in case of failure to agree, the determination of said amount shall be referred to arbitration, as provided for in Art. XII. of this contract.

ART. IV. The Contractor shall provide sufficient, safe and proper facilities at all times for the inspection of the work by the Architect or . . . authorized representatives. He shall, within twenty-four hours after receiving written notice from the Architects to that effect, proceed to remove from the grounds or buildings all materials condemned by . . . . . whether worked or unworked, and to take down all portions of the work which the Architects shall by like written notice condemn as unsound or improper, or as in any way failing to conform to the drawings and specifications, and shall make good all work damaged or destroyed thereby.

ART. V. Should the Contractor at any time refuse or neglect to supply a sufficiency of properly skilled workmen, or of materials of the proper quality, or fail in any respect to prosecute the work with promptness and diligence, or



fail in the performance of any of the agreements herein contained, such refusal, neglect or failure being certified by the Architect, the Owner shall be at liberty, after . . . . days' written notice to the Contractor, to provide any such labor or materials, and to deduct the cost thereof from any money then due or thereafter to become due to the Contractor under this contract; and if the Architect shall certify that such refusal, neglect or failure is sufficient ground for such action, the Owner shall also be at liberty to terminate the employment of the Contractor for the said work and to enter upon the premises and take possession, for the purpose of completing the work included under this contract, of all materials, tools and appliances thereon, and to employ any other person or persons to finish the work, and to provide the materials therefor; and in case of such discontinuance of the employment of the Contractor . . . . shall not be entitled to receive any further payment under this contract until the said work shall be wholly finished, at which time, if the unpaid balance of the amount to be paid under this contract shall exceed the expense incurred by the Owner in finishing the work, such excess shall be paid by the Owner to the Contractor, but if such expense shall exceed such unpaid balance, the Contractor shall pay the difference to the Owner. The expense incurred by the Owner as herein provided, either for furnishing materials or for finishing the work, and any damage incurred through such default, shall be audited and certified by the Architect, whose certificate thereof shall be conclusive upon the parties.

ART. VI. The Contractor shall complete the several portions, and the whole of the work comprehended in this Agreement by and at the time or times hereinafter stated, to wit: . . . . .

ART. VII. Should the Contractor be delayed in the prosecution or completion of the work by the act, neglect, or default of the Owner, of the Architect, or of any other contractor employed by the Owner upon the work, or by any damage caused by fire, lightning, earthquake, cyclone or other casualty for which the Contractor is not responsible, or by strikes or lockouts caused by acts of employees, then the time herein fixed for the completion of the work shall be extended for a period equivalent to the time lost by reason of any or all of the causes aforesaid, which extended period shall be determined and fixed by the Architect; but no such allowance shall be made unless a claim therefor is presented in writing to the Architect within forty-eight hours of the occurrence of such delay.

ART. VIII. The Owner agrees to provide all labor and materials essential to the conduct of this work not included in this contract in such manner as not to

delay its progress, and in the event of failure so to do, thereby causing loss to the Contractor, agrees that he will reimburse the Contractor for such loss; and the Contractor agrees that if he shall delay the progress of the work so as to cause loss for which the Owner shall become liable, then he shall reimburse the Owner for such loss. Should the Owner and Contractor fail to agree as to the amount of loss comprehended in this Article, the determination of the amount shall be referred to arbitration as provided in Article XII of this contract.

ART. IX. It is hereby mutually agreed between the parties hereto that the sum to be paid by the Owner to the Contractor for said work and materials shall be \$ . . . . . subject to additions and deductions as hereinbefore provided, and that such sum shall be paid by the Owner to the Contractor, in current funds, and only upon certificates of the Architect, as follows: . . . . .

The final payment shall be made within . . . . . days after the completion of the work included in this contract, and all payments shall be due when certificates for the same are issued.

If at any time there shall be evidence of any lien or claim, for which, if established, the Owner of the said premises might become liable, and which is chargeable to the Contractor, the Owner shall have the right to retain out of any payment then due or thereafter to become due an amount sufficient to completely indemnify him against such lien or claim. Should there prove to be any such claim after all payments are made, the Contractor shall refund to the Owner all moneys that the latter may be compelled to pay in discharging any lien on said premises made obligatory in consequence of the Contractor's default.

ART. X. It is further mutually agreed between the parties hereto that no certificate given or payment made under this contract, except the final certificate or final payment, shall be conclusive evidence of the performance of this contract, either wholly or in part, and that no payment shall be construed to be an acceptance of defective work or improper materials.

ART. XI. The Owner shall during the progress of the work maintain insurance on said work, in his own name and in the name of the Contractor, against loss or damage by fire, lightning, earthquake, cyclone or other casualty. The policies to cover all work incorporated in the building, and all materials for the same in or about the premises, and shall be made payable to the parties hereto, as their interest may appear.

ART. XII. In case the Owner and Contractor fail to agree in relation to matters of payment, allowance or loss referred to in Arts. III or VIII of this contract, or should either of them dissent from the decision of the Architect

referred to in Art. VII of this contract, which dissent shall have been filed in writing with the Architect within ten days of the announcement of such decision, then the matter shall be referred to a Board of Arbitration consisting of . . . . . in behalf of the Owner, and . . . . . in behalf of the Contractor, these two to select a third. The decision of any two of this Board shall be final and binding on both parties hereto. In event of the death or inability to serve of the party named in behalf of the Owner, then the Owner shall select a person in his place; in the event of the death or inability to serve of the party named in behalf of the Contractor, then the Contractor shall select a person in his place; in event of the death or inability to serve of the third party, then the remaining arbitrators shall choose a person in his place. Each party hereto shall pay one-half of the expense of such reference.

ART. XIII. The said parties for themselves, their heirs, successors, executors, administrators and assigns, do hereby agree to the full performance of the covenants herein contained.

*In Witness Whereof*, the parties to these presents have hereunto set their hands and seals, the day and year first above written.

*In presence of* . . . . .  
 . . . . .

## The Yale & Towne Standard Contract.

This has been very carefully framed to cover all the conditions involved in the furnishing of hardware by contract, under any of the plans previously described, and is a better form for this purpose than the foregoing general one designated to cover contracts relating to work and materials of every kind. Copies of it are obtainable on application to The Yale & Towne Mfg. Co., 9-11-13 Murray St., New York City. Its text is as follows, viz :

THE YALE & TOWNE MFG. CO.

### Contract for Finishing Hardware.

No. . . . .

Made this . . . day of . . . . . in the year one thousand, nine hundred and . . . . . By and between The Yale & Towne Manufacturing Company, of New York City, hereinafter designated as the "Company," party of the first part, and . . . . . of . . . . . in the County of . . . . . and State of . . . . . doing business under the firm name and style of . . . . . hereinafter designated as the "Purchaser," party of the second part.

*Witnesseth*, That the said parties, in consideration of One Dollar (\$1.00),

each to the other in hand paid, receipt whereof is hereby acknowledged, and of the covenants and agreements herein set forth, do hereby mutually agree for themselves and their legal representatives, each with the other, as follows, to wit:

1. **LOCATION AND NAMES.** That this contract shall cover the hardware specified in the schedule attached hereto and intended for use in  
 Building . . . . . Location . . . . . Name of Owner . . . . . Name of Architect . . . . . Name of Contractor . . . . . Name of Dealer . . . . .
2. **DELIVERY.** That delivery of said hardware shall be made by said Company at . . . . .
3. **CHARACTER OF GOODS.** That said hardware shall conform in kind and quantity to the schedule attached hereto and forming part hereof, and shall all of it be of thoroughly first-class workmanship and material, made in conformity with the established standard of said Company for goods of each of the various kinds specified, and in accordance with such drawings, specifications or samples as may have been submitted in connection herewith and mutually agreed on.
4. **INSPECTION.** That all of the hardware so furnished shall be subject on behalf of the Purchaser to inspection and approval, when and as delivered, by . . . . .
5. **RECEIPTS.** That said Company, at the time of each delivery, shall furnish said Purchaser with a memorandum invoice, in duplicate, specifying the goods so delivered, and that upon receipt and inspection of such shipment one of these invoices shall be signed by said Purchaser or by a person designated by him for that purpose, and returned to said Company in acknowledgement of receipt of the goods. Failure so to sign and return such receipts within five days after the arrival of goods to constitute an acknowledgement of their receipt, unless prior claim be made by the Purchaser for shortages or other non-conformity with contract.
6. **INFORMATION.** That the said Purchaser shall furnish to the said Company, either at the execution hereof or from time to time, reasonably in advance, a list of the hardware as it may be needed at the building, which list shall specify the quantity required; the catalogue numbers of locks and hardware; the metals and finishes to be used; and all necessary information as to dimensions, thickness, hand and bevel of doors; corresponding details concerning sashes or other wood work on which said hardware is to be used; and all other information needed by the said Company to enable it to

design, manufacture, finish, label and deliver said hardware; the said Purchaser to furnish with such list, any drawings or sketches which may reasonably be needed for the correct understanding of the facts, in order that the said Company may thus be enabled to provide said hardware as needed, to label it as desired, and to deliver the same as said Purchaser may request, the said Company not to be responsible for any delays which may arise because of the failure of the said Purchaser thus to supply this information.

7. **PAYMENT.** That the contract price for the hardware covered by this contract and included in the schedule annexed hereto, shall be \$ . . . . . and that such sum shall be paid in current funds by the Purchaser to the Company in installments as follows, viz: Ninety per cent. (90%) of the value of the goods delivered in any calendar month shall be paid on or before the fifteenth day of the succeeding month, the Company having previously made a written application to the Purchaser for such payment, showing the value of the goods delivered as above, this application being subject to approval by the architect, provided, however, that such approval shall not be delayed more than ten days after the delivery of such application by the Company to the Purchaser; and the remaining ten per cent. (10%) thus reserved to be payable within thirty days after the final completion and delivery of all the hardware covered by this contract; provided, however, that if the inspection and approval of said hardware is delayed more than ten days after delivery of the goods no payment due under the foregoing terms shall be deferred because of such failure more than ten days beyond the time hereinabove stipulated.

8. **DRAWINGS.** That in case any of the work covered by this contract is executed from drawings furnished by either of said parties, to the other, a copy of such drawing or drawings shall be submitted by the party furnishing it to the other, and be signed by both, such signed copy becoming thereby a record of the agreement between said parties as to the details of the work covered by such drawings.

9. **CHANGES.** That no additions to, or deductions from, the goods covered by the schedule attached hereto shall be made, nor any changes in the details thereof, except by written order from the said Purchaser, or from the architect or other agent duly authorized by him, to said Company, accepted in writing by the latter, and that no claim shall be made by said Company for extra compensation for additional goods furnished, nor by said Purchaser for allowance for goods not furnished or returned unless such changes from this contract, and the schedule attached hereto, shall have

been mutually agreed upon in writing and the amount to be added to or deducted from the contract price herein named noted over the signatures of the parties hereto on the memorandum of such supplementary agreement.

**10. LIABILITY.** That when any of the goods covered by this contract shall have been delivered as aforesaid by the said Company its responsibility for such goods, except as to their quality and workmanship, shall thereupon cease and determine, and that any loss or damage to such goods which thereafter may result from fire, the acts of workmen or other persons, or from any other cause whatsoever, shall be borne by the said Purchaser.

**11. DATES OF DELIVERY.** The said Company hereby agrees, subject only to unavoidable delays arising from strikes, lockouts, fire, action of the elements, or other causes beyond its reasonable control, to complete and deliver said hardware on or before the following date or dates, viz : . . . . .

**12. NON-PERFORMANCE.** Should the Company at any time refuse or neglect to furnish the hardware covered by this contract in conformity with the conditions herein set forth, or if any hardware so furnished fails to conform in quality or otherwise to the conditions of this contract, or fail in any respect to prosecute the work with promptness and diligence, or fail in the performance of any of the agreements herein contained, such refusal, neglect or failure being certified by the architect, the Purchaser shall be at liberty, after ten days written notice to the Company, to provide other hardware of similar kind and quality, and to deduct the cost thereof from any money then due, or thereafter to become due, to the Company under this contract, the expense incurred by the Purchaser on this account for obtaining such hardware to be audited and certified by the architect, whose certificate thereof shall be conclusive and binding upon the parties.

**13. ARBITRATION.** That in the event of any disagreement arising between the parties hereto concerning any matters under this contract, or concerning any claims for damages because of the failure of either of the parties hereto to conform to its obligations, it is hereby mutually agreed that the matter so in dispute shall be referred to the architect for decision and award. In the case of dissent from such award by either party hereto the matter at issue shall be referred to three disinterested arbitrators, one to be appointed by each of the parties to this contract and the third by the two thus chosen, the decision of any two of whom shall be final and binding, and each of the parties hereto shall pay one-half of the expenses of such reference.

In Witness whereof, the said two parties have executed this contract in duplicate and have hereunto affixed their hands and seals this . . . . . day of . . . . . 189

Witnesses present : . . . . .  
 . . . . .

THE YALE & TOWNE MFG. CO.

### Schedule of Hardware

Referred to in Contract No. . . . . , dated . . . . .

QUANTITY			List No.	Description	Finish	Price	Amount
Only	Pairs	Dozen					

THE YALE & TOWNE MFG. CO.

AGREEMENT FOR EXTRA WORK. To be attached to Contract No. . . . . dated . . . . . between the Yale & Towne Manufacturing Company (referred to therein as said Company), and the following purchaser . . . . .

The said Purchaser hereby requests the said Company to furnish the additional material described below, at the prices named, under the terms and conditions of the original contract above referred to, and said Purchaser hereby agrees to make payment for such additional material on the same terms and in the same manner as provided for in said contract.

. . . . . 189

(Signature) . . . . .

QUANTITY			List No.	Description	Finish	Price	Amount
Only	Pairs	Dozen					

## SIMPLE FORM OF CONTRACT.

For minor transactions, when the quantity and value of hardware involved is small, the following brief form may be used, viz :

## Contract for Finishing Hardware.

Contract made this . . . . day of . . . . ., 19 . . . between . . . . .  
 . . . . . Owner, and . . . . . Contractor. The Contractor  
 agrees to furnish, and to deliver at . . . . . all of the hardware stated  
 below, according to instructions, drawings and specifications made by . . . . .  
 Architect, for the sum of . . . . . \$ . . . . . The hardware  
 covered by this contract is as follows :

*( Here insert specification. )*

The Owner agrees to pay the Contractor the said amount of . . . . .  
 \$ . . . . ., as follows : . . . . . The Contractor agrees that all  
 hardware covered by this contract shall be of standard quality, material and  
 finish, that delivery of the same, complete, shall be made within . . . . weeks  
 from the date when he shall have received all necessary instructions and de-  
 tailed information, and that the decision of the Architect as to any and all  
 questions relating thereto shall be final and binding upon the Contractor.



## Section 4.

---

### Examples of Architects' Practice in Specifications for Builders' Hardware.

**I**N the office of nearly every architect may be found some form of specification, sometimes elaborate but usually brief, intended to cover Builders' Hardware. However suitable these may have been under the conditions formerly existing, few if any of them are well adapted to present conditions and to the development which American hardware has achieved during recent years. Nevertheless, it will be found interesting, and in some cases helpful, to examine the methods of specifying Finishing Hardware which prevail at the present time and to contrast these with the forms herein recommended. Accordingly the following examples of actual specifications now used by prominent architects are given.

#### Example (a).

##### FOR A CITY RESIDENCE.

*(Plan 1. Hardware Reserved. See page 996.)*

All finishing hardware for this building shall be selected and purchased by the architects and will be received and taken care of by the carpenter contractor, who will be responsible for same. It shall be fitted and applied in the most workmanlike manner with due care to the finishes. All knots shall be protected by cotton flannel which shall be allowed to remain until the work is completed. All cutting and fitting shall be done before the woodwork is painted or varnished and the hardware shall be applied after all painting and varnishing.

The above reservation does not include constructional hardware such as nails,

screws, sash pulleys, sash weights, iron chains, iron gates, etc., etc., nor does it include the setting of the hardware.

The carpenter contractor shall furnish to the hardware contractor any information which may be necessary for him to furnish the hardware to fit the various conditions.

## Example (b).

### FOR AN APARTMENT HOUSE.

(*Plan 1. Hardware Reserved. See page 996.*)

All finishing hardware for this building shall be selected and contracted for by the owner, to be received and taken care of by the carpenter who will be responsible for same after delivery and who shall fit all material in the most workmanlike manner.

All rough hardware such as nails, sash pulleys, screws, sash chains, sash weights, hand rail brackets, etc., shall be furnished by the contractor at his cost.

## Example (c).

### FOR A RECTORY AND CHURCH.

(*Plan 2. Method A. Hardware specified definitely. See page 996.*)

All hardware to be used in these buildings shall be of solid cast bronze or brass metal; all to be highly polished and free from defects of any kind. Any defective pieces shall be replaced by this contractor at his expense.

**FINISHES.**—On the outside of all entrance doors the hardware will be of cast brass, ship finish: all the hardware throughout all toilet and bath rooms to be nickel plated finish: all other hardware to be natural bronze finish. The catalogue numbers and ornamentations hereinafter mentioned refer to the catalogue of the Yale and Towne Mfg. Co. All goods must be equal or similar to those designated by such numbers.

### RECTORY.

Main Entrance Doors to Basement—

750 Butts, 5 × 5 inches.

726R Lock, master-keyed, with 2 half pair special Lever Handles, ebony and brass for outside, and 2 half pair W55 Knobs, no rose, inside: 401 ½ special Escutcheon Plates outside, and 2 5/7426 Escutcheon Plates inside.

283 Bolt, 18 inch, and one 12 inch.

147 Butts, 3×3 inches.

1187 Transom Catch and 1332 Transom Chains, 12 inch.

Garden Entrance Door: Vestibule to Passage, and Vestibule to Ante-room—

780 Butts, 5×5 inches.

726 Lock, masterkeyed, electric strike, pair W 55½ Knob and 5/7401½ and 5/7426 Escutcheons.

147 Butts, 3×3 inches; B265 Transom Lifts and size 4 Blount Check.

Vestibule Door to Main Hall (Double Acting)—

Double Acting Bommer Spring Hinges.

304¼ Cylinder Dead Lock, master-keyed.

71730 Push Plates (20 by 4 inches).

Kick Plates both sides (12 inches high by 1 inch thick).

First Floor Entrance Door to Church—

750 Butts, 5×5 inches.

726 Lock, with special Lever Handles, and 401½ Escutcheon (Bordeaux design) outside; and W56 Knob and 5/7426 Escutcheon inside.

Sliding Doors—

McCabe Sliding Door Hangers complete with Guides, Stops, etc.

1706 Lock, with 854 Escutcheon, Bristol design.

Hall Door to Degagement Passage—

780 Butts, 5×5 inches.

726 Lock, master-keyed, with Electric Strike, dry battery wires, etc.

14 Knobs, 401½ and 426 Escutcheons, Bristol design.

Size 4 Blount Door Check.

Kick Plate on hall side 12 inches high by 1½ inch thick.

Dining Room Door to Pantry (double acting)—

Double Acting Bommer Spring Hinges.

1730 Push Plates, both sides, Bristol design.

Kick Plates, both sides, 12 inches high by 1½ inch thick.

All Other Single and Double Interior Doors on First Floor—

780 Butts, 5×5 inches.

1440 Locks, master-keyed, 14 Knobs and 411 Escutcheons, Bristol design, and 283 Bolts.

All Other Single and Double Interior Doors, not otherwise mentioned throughout Cellar, Basement, 2nd and 3rd Floors.

780 Butts, 5×5 inches; 283 Bolts.

1440 Locks, master-keyed, W56 Knobs and 5, 7411 Escutcheons.

In addition to the above, the Doors to the Wine Cellar and Wine Closet (in cellar) are to have—

348 Cylinder Dead Locks.

Doors to Medicine Chest—

780 Butts, 2×2 inches.

PA152 Locks, RA783 Keys and 812 Key Plates.

Cut-out Box Doors—

780 Butts 2½×2½ inches, and PA208 Locks alike.

Dumb-waiter Doors—

71349 Sash Lifts.

Hinged Sash in Cellar—

147 Butts, 3×3 inches; Barrel Bolts 3-inch brass, and Hooks and Eyes 6-inch brass.

Double Hung Sash (1st floor)—

24 Sash Fast, 1349 Sash Lifts, Bristol design, Stop Bead Screws and Washers.

Double Hung Sash throughout the Building not otherwise mentioned—

24 Sash Fast, 71349 Sash Lifts, Stop Bead Screws and Washers.

Partition Sash throughout Building—

1335 Sash Centers, with friction springs; 1188 Transom Catches, and 1332 Transom Chains.

Circular Sash (3rd floor)—

1335 Sash Centers and 1069 Turnbuckles

Casement Sashes—

Butts, Special, 4 inches high, made to fit condition.

893 Cremorne Bolts for Windows opening in, and 895 for those opening out. Plain for Basement and Fairfax for 1st floor.

1393 or 1394 Adjusters for Sash opening in; 1396 for those opening out.

280 Bolts.

Transoms over Windows and Interior Doors—

147 Butts, 3×3 inches; B265 Transom Lifters.

1358 Sash Hooks on Ash poles; one for each floor.

Hooks—

413 Coat and Hat Hooks, and 713 Ceiling Hooks for closets.

## CHURCH.

## Outside Entrance Doors to Vestibule—

Ball Bearing Pivot Hinges made special with quadrants, etc., complete.  
658 Lock, master-keyed. Special ebony Lever Handles outside : Knobs  
inside and Escutcheons both sides.

Hinge Straps, Studs, Door Stops and Hooks. Special.

888 Extension Bolts.

## All Other Entrance Doors—

750 Butts, 6×6 ins.

658 Lock, master-keyed. Special ebony lever Handles outside, W 55

Knobs inside; special Escutcheon outside and 7/7424 Escutcheon inside.

Hinge Straps, Door Stops and Hooks. Special.

283 Bolts and size 5 Blount Door Checks.

*Note—All special items to be as per details and designs furnished by Architects.*

## Entrance Doors to Engine and Boiler Rooms—

750 Butts 5×5 ins.

726 Lock master-keyed. W 55½ Knob and 7/7401½ Escutcheon out-  
side and 5/7426 Escutcheon inside.

## Double Acting Entrance Doors—

Double Acting Spring Hinges : 344¼ Cylinder Dead Lock, master-keyed.

7/1730 Push Plates 20×4 ins., Kick Plates 1½ in. thick.

283 Bolts and 1109 Door Stops.

Passage Doors to Church, Rear Entrance Door to Lobby, Vestry Lobby Doors  
to Vestry, Lobby Doors to Sanctuary, or any other doors marked on  
the Plans to have Cylinder Locks.

780 Butts, 5×5 ins.

726 Lock, master-keyed. W 56 Knobs and 5/7401½ Escutcheon  
outside and 5/7426 Escutcheon inside.

Size 4 Blount Door Checks.

## All Other Single and Double Interior Doors—

780 Butts, 5×5 in.

1440 Lock, master-keyed. W 56 Knobs and 5/7411 Escutcheons.

283 Bolts.

Size 4 Blount Door Checks.

## Double Acting Interior Doors—

Double Acting Spring Hinges : 348 Dead Locks, master-keyed.

71730 Push Plates 20×4 ins., and Kick Plates ½ in. thick.

283 Bolts.

Double Hung Sashes—

24 Sash Fasts, 71349 Sash Lifts and 410 Sash Sockets.

1358 Sash Hooks on Ash poles : Stop Bead Screws and Washers.

Casement Sashes—

Special Butts 4 ins. high : 893 Bolts : 1396 Adjusters and 280 Bolts.

Pivoted Sashes—

1335 Sash Centers and 1388 Casement Adjusters.

Transoms over Doors and Sashes—

147 Butts, 3×3 ins., and B265 Transom Lifters.

## Example (d).

### FOR A MUNICIPAL BUILDING.

(*Plan 2. Method A. & B. Hardware specified definitely. See page 996.*)

All hardware of the types and kinds hereinafter described shall be of the best manufacture and shall be subject to the approval of the architects.

A complete line of samples representing the intention of each bidder shall be placed on file in the architect's office ; those of the successful bidder to remain on file until the completion of the contract.

All hardware shall be complete with screws necessary to properly apply same.

All hardware shall be properly wrapped and distinctly marked for each opening and each floor ; a schedule or list accompanying each shipment, enclosed in the case or bundle.

All Locks shall be guaranteed to operate satisfactorily for one year after application.

All Locks, Latches, etc. shall center their respective door stiles with Knob-hole and key-hole ; the faces shall be beveled to suit the bevel of doors and all lips of strikers fully protect the trim from injury by the latch bolt.

All Cylinder Locks shall be master-keyed by floors with three Grand Master Keys. This will not apply to any entrance door lock.

The carpenter contractor shall receive receipt and be responsible for all hardware delivered. He shall properly set and apply all finishing hardware hereinafter described, retaining each knob in its flannel covering until the work is completed.

The carpenter contractor shall co-operate with the hardware contractor, furnishing him with all necessary details and information of woodwork at least three months in advance of the time the hardware is required.

**QUALITY**—All hardware shall be of plain, heavy cast bronze or brass as may be required.

**BUTTS**—All butts shall be solid cast bronze, five knuckles, steel bushed at every joint, self lubricating, loose pin with "retaining pin" device. All butts shall be of the heights stated below and wide enough to clear the trim wherever necessary; two butts to each leaf for doors 7 feet or under and three butts to each leaf for doors over 7 feet.

All doors  $1\frac{1}{8}$  ins. thick shall have butts 4 ins. high No. 780.

" "  $1\frac{3}{4}$  " " " " " " 5 " " " 750.

" "  $2\frac{1}{4}$  " " " " " " 6 " " " "

" "  $2\frac{3}{4}$  " " " " " " 6 " " " "

Butts, 4 ins., shall weigh 2 lbs. for  $4\times 4$  ins., without screws or paper.

" 5 " " " 4 " 5 oz. for  $5\times 5$  ins. " " "

" 6 " " " 6 " 6 " "  $6\times 6$  ins. " " "

All other sizes shall weigh in proportion.

All hinged casements shall have *three* butts for each leaf to sash over 5 feet high, and *two* butts for sash under 5 feet high. Butts to measure  $4\times 4$  ins. and to have 5 knuckles, steel bushed at every joint, self-lubricating, fast pin, to weigh 2 lbs. per pair without screws or papers, (350).

All water closet doors shall be hung with spring clamp hinges (270) for marble, with reverse spring to hold door open if desired.

All cut-out boxes shall be hung with one pair butts (780)  $3\times 3$  inches.

**PIVOTS**.—All doors 4 inches thick shall have extra heavy Steel Pivots top and bottom for each leaf to suit detail.

**LOCKS**.—All doors except main entrance, janitor's quarters, rooms 89-90 and doors 4 inches thick, shall have heavy cylinder office lock of Yale type (654) knob to operate latch at all times, and key to operate dead bolt from both sides; japanned iron case  $5\frac{1}{2}\times 3\frac{5}{8}$  inches, with armor plate for face, three keys each.

All entrance doors (4 inches thick) shall have cylinder lock Yale type (658), japanned iron case  $6\frac{1}{2}\times 4$  inches, with extra heavy reinforced face measuring  $12\times 1\frac{3}{4}$  inches, and four screw holes.

Doors in rooms 89 and 90 (also janitor's quarters) shall have lock (1500)  $4\frac{1}{4}\times 3\frac{1}{2}$  inch case, with easy spring and three rolled polished steel lever tumblers, two nickel-plated forged steel keys each.

All single water closet doors shall have flush rim lock  $4\frac{3}{8}\times 3\frac{3}{8}$  inches (1784), knob to operate latch both sides, key to operate dead bolt outside and thumb knob to operate dead bolt inside; to have three lever tumblers each, and

three forged steel keys, complete with knobs, thumb-knobs, roses, key plates and strikers, with rubber bumper for marble.

All double water closet doors to have extra heavy Brass Latch (1076½).

Cut-out boxes shall have suitable brass cabinet locks (PA200), flat key, 2 tumblers.

**ESCUTCHEONS.**—All doors (except main entrance and cut-out boxes, janitor's quarters and rooms 89 and 90) to have combined rose and escutcheons 6/6420, 9½ × 2¾ inches, both sides of each leaf; double trim for double doors to measure 9½ × 2¾ inches, square corner, wide bevel, and to have high bracket-bearing thimbles; janitor's quarters and rooms 89 and 90 to have escutcheons 3/6410, to measure 6 × 2 inches, and to have bracket-bearing thimble knobs.

**KNOB.**—All knobs (except the janitor's quarters and rooms 89 and 90) shall be 2½ inches heavy cast metal, with the monogram U. C. set in suitable ornamental wreath, to have adjustable screwless spindles; janitor's quarters and rooms 89 and 90 shall have 2¼-inch solid bronze knob with screwless spindle.

**BOLTS.**—Main entrance doors shall have extra heavy mortise top and bottom bolts, extending through the entire length of each leaf; same to be operated by heavy T-handle only and dead locked by key from inside only; two No. 186 bolts to each pair of doors. All doors 4 inches thick shall have two No. 988 bolts; all other double doors shall have two No. 283 bolts.

**ADJUSTERS.**—All casement windows shall have adjusters. Those less than 4 feet 6 inches from floor to have adjusters No. 1395 (extra heavy with star section rod) of suitable length to swing sash at right angle. Those over 4 feet 6 inches from floor to have approved adjusters operated by ½ inch bronze rod; handle not to be more than 5 feet from floor.

**CATCHES.**—All casement windows shall have extra heavy, easy spring, mortise latches with ringed lever handle or other device to enable latch bolt to be retracted by either string or pole hook from floor.

**POLE HOOKS.**—Provide (ash) poles of suitable length with pole hook (1358).

**HOO.**—Provide and set (six) heavy coat hooks (513) in all closets, water closets and slop sinks and two by each wash-basin; to have expansion bolts where marble is set.

**TRANSOMS.**—Provide and set two heavy bronze transom lifts B166 to each opening for transom over vestibule.

**DOOR STOPS.**—Provide and set rubber tipped wooden door stops for all doors where wooden base, and metal door Stops 1109 with expansion bolts where marble or cement base.



## Example (e).

### LOCK SPECIFICATION USED FOR A LEADING NEW YORK HOTEL.

(Numbers refer to the Yale & Towne Mfg. Co.)

(*Plan 2. Method A. Hardware specified definitely. See page 996.*)

#### FOR SINGLE DOORS FROM CORRIDORS TO ROOMS

**No. 1 COMBINATION.**—One No. 1685 two-bolt corridor lock, latch bolt operated by knobs from both sides; dead bolt operated by master-key and guest's key from hall side, and by guest's key only from inside; this lock master-keyed by floors; the change or guest's key to be all different throughout the building.

One No. 1050 thumb bolt on inside.

#### FOR DOUBLE DOORS FROM CORRIDORS TO ROOMS.

**No. 2 COMBINATION.**—Same arrangement of locks and keys as in Combination No. 1, except adapted to double instead of single doors.

#### FOR SINGLE SLIDING DOORS FROM CORRIDORS OR PRIVATE HALLS TO ROOMS.

**No. 3 COMBINATION.**—One No. 1706  $\frac{1}{2}$  lock with spring pull operated from face of lock; dead bolt operated from both sides by floor master-key and by guest's key.

One No. 1050S thumb bolt, operated from inside only.

#### FOR DOUBLE SLIDING DOORS FROM CORRIDORS OR PRIVATE HALLS TO ROOMS.

**No. 4 COMBINATION.**—Same arrangement of locks and keys as in Combination No. 3, except adapted to double instead of single sliding doors.

#### FOR PUBLIC TOILETS, SLOP HOPPERS, FURNITURE CLOSETS AND SERVING ROOM.

**No. 5 COMBINATION.**—One No. 1470 two-bolt lock; latch bolt operated from both sides by knobs; dead bolt from outside only by key, set to floor master-key only.

#### FOR BAGGAGE ROOM DOORS.

**No. 6 COMBINATION.**—One No. 1000 latch, operated by knob from both

sides; one No. 344 Yale dead lock, operated by key from outside only; keys alike for all baggage rooms throughout the building.

FOR DOORS FROM PUBLIC TOILET INTO PUBLIC BATH ROOMS.

No. 7 COMBINATION.—One No. 1470 two-bolt lock, operated by knob from both sides, and by floor master-key from outside only.

One No. 1050 thumb bolt, operated from inside only.

FOR SINGLE COMMUNICATING DOORS.

No. 8 COMBINATION.—One No. 1525 three-bolt lock; latch bolt operated by knob from both sides and with two thumb bolts, one operated from each side.

One No. 1300 lock, set to floor master-key only and operated from one side only.

FOR DOUBLE COMMUNICATING DOORS.

No. 9 COMBINATION.—Same as No. 8 Combination, except that locks are adapted to double doors with rabbetted joint.

FOR TWIN COMMUNICATING DOORS.

No. 10 COMBINATION.—Each door to have one No. 1505 two-bolt lock; latch bolt operated by knob from room side and by lever handle from the other side, with thumb bolt operated from room side only; one door of each pair to have one No. 1300 dead lock set to floor master-key only, and operated from one side of door only.

FOR PRIVATE BATH-ROOM DOORS.

One No. 1402 three-bolts lock; latch bolt operated by knob from both sides; dead bolt operated by key from outside only; keys to be alike throughout the building and different from all other keys. Thumb bolt operated from inside only.

No. 11 COMBINATION.—Note: The above applies (except where bath-room communicates with two other rooms, in which case each bath-room door to be trimmed with the No. 3 Combination.)

TO CLOTHES CLOSETS IN GUEST'S ROOMS.

No. 12 COMBINATION.—One No. 1501 two-bolt lock; latch bolt operated by knob from both sides; dead bolt operated by guest's key of combination No. 1 from room side only; each lock on a floor to have a key differing from any other lock on same floor.

FOR SINGLE SLIDING COMMUNICATING DOORS.

No. 13 COMBINATION.—One No. 1704½ lock, with spring pull operated from face of lock, and two thumb bolts, one operated from each side of door.

One No. 1300S dead lock, set to floor master-key only and operated by key from one side only.

FOR INNER OR VESTIBULE DOORS TO ROOMS NEAR ELEVATORS.

No. 14 COMBINATION.—One No. 1000 knob latch, operated by knob from both sides.

FOR DOORS FROM BUTLER'S PANTRY TO GUEST'S ROOM.

No. 15 COMBINATION.—One No. 1505 two-bolt lock, latch operated from both sides by knob and thumb bolt from room side only.

## Section 5.

### Grades and Numbers of Yale & Towne Line.

**A**S a guide to the selection of Locks and Hardware proper for all conditions and uses, the following Classified Table has been compiled, in which the division into three *grades* is based on the conditions explained in Part II, Sec. 3 (page 117).

Except when otherwise specified the figures in each column indicate the *catalogue numbers* of The Yale & Towne Mfg. Co., and in such cases the grading is that of the makers; in other cases the grading is that which, without preference or prejudice, is believed fairly to conform to the facts.

By availing of the Numerical Index, page 1104, the detailed description of each article can readily be found, in case information is desired as to construction, dimensions or prices. In the case of ornamental hardware the design should be indicated by *name*, and in *all* cases the desired metal and finish should be indicated by the appropriate *symbol* (see pages 609 to 612). The catalogue numbers usually indicate only the size and *mechanical features* of the article, not the metal or finish.

#### ENTRANCE DOORS.

RESIDENCES—	Best.	Medium.	Common.	
Butts, . . . . .	750	780	47	
Locks {	Cylinder type, . . . . .	234½	726	750
	Lever-tumbler type, . . . . .	2000½	P3510	P1842
Bolts {	Extension, . . . . .	383	383	2383
	Flush, . . . . .	283	481	2715
Push Buttons, . . . . .	1416	1415	W3416	
Door Stops, . . . . .	1108	1103	2105	
Door Checks (Blount), . . . . .	See pages 786 to 788			
Trim, as desired, . . . . .	See Parts III, V and VII			

## ENTRANCE DOORS—Continued.

RESIDENCES—Continued.	Best	Medium.	Common.
Sliding Door Lock, . . . . .	234S	246½S	246½S
Trim, for Sliding Door Lock, . . . . .	800	800	800
IRON AND GRILLE DOORS—			
Butts, with Machine Screws, . . . . .	750	750	750
Locks—Special, . . . . .	234½	726	726

## PUBLIC BUILDINGS—

Butts, . . . . .	750	780	780	
Locks {	Store Door Type, . . . . .	732	414	P2533
	Knob Type, . . . . .	658	654	660
Bolts {	Extension, . . . . .	186	188	888
	Flush, . . . . .	283	481	2715
Door Checks (Blount), . . . . .	See pages 786 to 788			
Door Stop, Metal, . . . . .	1108	1103	2105	
Kick Plates, if desired. Give size of lower panel of door.				
Brass Guards, if desired. Give description and state width of door.				
Trim, as desired, . . . . .	See Parts III, V and VII			
If Self-acting Butts are desired, see "Double-acting Doors" page 1047; also see "Double-acting Hinges," page 199.				

## DUTCH DOORS—

Butts—2 pairs, . . . . .	750	780	47	
Bolt—Rabbeted, . . . . .	493	494	494	
or Latch—Rabbeted . . . . .	1000R	P1702R	P1702R	
and Brass Quadrant, if desired, . . . . .	Special.	Special.	Special.	
Knob Lock {	Upper half, . . . . .	348	1200	1300
	Lower half, . . . . .	726	750	P3510
or				
Thumb Latch {	Upper half, . . . . .	348	1200	1300
	Lower half, . . . . .	1122	P2025	P2025
Handle—Combining Both Thumb Latch and Dead Bolt—Plate cut through above Grip, . . . . .	Selected.	Selected.	Selected.	
or				
Lock—Upper half, . . . . .	348	1200	1300	

ENTRANCE DOORS—Continued.

DUTCH DOORS—Continued.	Best.	Medium.	Common.
Lift Latch, . . . . .	1176	2020	2020
Door Knockers, . . . . .	See pages 873 to 876		
Hinge Plates, . . . . .	See pages 847 to 869		

MASONIC OR SECRET SOCIETY LODGES—

Butts, . . . . .	750	780	47
Locks, . . . . .	726	750	P3510
Trim—Masonic Emblem, . . . . .	See pages 582 to 585		
Peep Hole, . . . . .	Sketch on application		
Door Knocker, . . . . .	See pages 873 to 876		

STORE DOORS—

SINGLE—

Butts, . . . . .	750	780	47
Locks—Cylinder, . . . . .	732	414	P2533
Handles, as desired, . . . . .	See pages 738 to 760		
Door Checks (Blount), . . . . .	See pages 786 to 788		
Letter Hole Plate, . . . . .	1505	1507	745
“ “ “ with Hood, . . . . .	1506	1508	747

DOUBLE—

Same as above but with dummy trim

Bolts	{ Extension, . . . . .	186	188	888
	{ Flush, . . . . .	283	481	2715

APARTMENTS FROM PUBLIC HALLS—

Sliding Door Latch, . . . . .	66S	66S	66S
Trim, . . . . .	827	827	827

BARNs—

Locks, . . . . .	246½S	274S	244½S
Trim, . . . . .	800	800	800

DOUBLE ACTING—

SINGLE—

Spring Hinges, . . . . .	American or Bommer.	Japanned.
or Pivots, . . . . .	Bardsley or Matchless.	“
Push Plates,	{ Plain, . . . . .	See pages 802 and 803
	{ Ornamental, . . . . .	See page 923
Kick Plates, if desired. . . . .	See pages 870 to 872	

## ENTRANCE DOORS—Continued.

DOUBLE ACTING—Continued.	Best.	Medium.	Common.
IN PAIRS—			
Spring Hinges, . . . . .	American or Bommer.		Japanned.
or Pivots, . . . . .	Bardsley or Matchless.		“
Bolts: Flush, . . . . .	283	481	2715
Push Plates, { Plain, . . . . .	See pages 802 and 803		
{ Ornamental, . . . . .	See page 923		
Kick Plates, if desired. . . . .	See pages 870 to 872		
Locks, . . . . .	344½	1200	1300
SINGLE ACTING—			
Same as above, but with			
Door Check (Blount) . . . . .	See pages 786 to 788		
Pull Handle (1 side) . . . . .	47	43	201
Push Plate (1 side) . . . . .	1730	W6730	S6730
IN PAIRS—			
Same as above, but with			
2 Checks (Blount), . . . . .	See pages 786 to 788		
Duplex Stop, . . . . .	1112	1112	1112
Butts, . . . . .	750	780	47
Kick Plates, if desired. . . . .	See pages 870 to 872		
STORM DOORS—			
Butts, . . . . .	750	780	780
Push Plates, { Plain, . . . . .	See pages 802 and 803		
{ Ornamental, . . . . .	See page 923		
Door Pulls, { Plain, . . . . .	See pages 844 to 846		
{ Ornamental, . . . . .	See pages 823 to 843		
Door Checks (Blount) . . . . .	See pages 786 to 788		
SCREEN DOORS—			
Butts, . . . . .	350	785	147
Latch, . . . . .	866	1012	530
Door Checks (Blount) . . . . .	See pages 786 to 788		
VESTIBULES—			
Butts, . . . . .	750	780	47
Locks, { Cylinder type, . . . . .	274½	766	790
{ Lever-tumbler type, . . . . .	2200½	P3510½	PI742
Bolts, { Extension, . . . . .	383	383	2383
{ Flush, . . . . .	283	481	2715

ENTRANCE DOORS—Continued.

VESTIBULES—Continued.	Best.	Medium.	Common.
Door Stop, . . . . .	1108	1103	2105
Door Checks (Blount), . . . . .	See pages 786 to 788		
Sliding Door Locks, . . . . .	274S	274S	274S
Trim, for Sliding Door Lock, . . . . .	800	800	800

INSIDE DOORS.

BATH ROOMS—

Butts, . . . . .	750	780	47
Locks, . . . . .	1525	P2405	P118
Trim, as desired, . . . . .	See Parts III, V and VII.		

BED ROOMS—

Butts, . . . . .	750	780	47
Locks With Thumb-Bolts, . . . . .	1402	P2535	P5918 <sup>1</sup> / <sub>2</sub>
or Locks Without Thumb-Bolts, . . . . .	1500	P2430	P2918 <sup>3</sup> / <sub>4</sub>
Trim, as desired, . . . . .	See Parts III, V and VII.		

CLOSETS—

Butts, . . . . .	750	780	47
Locks, . . . . .	1500	P2430	P2918 <sup>3</sup> / <sub>4</sub>
Coat Hooks, . . . . .	513	2513	2513
Ceiling Hooks, . . . . .	713	2713	2713
Trim, as desired, . . . . .	See Parts III, V and VII.		

COMMUNICATING DOORS—

Butts, . . . . .	750	780	47
Locks, . . . . .	1504	P2400	P118 <sup>1</sup> / <sub>2</sub>
Trim, as desired, . . . . .	See Parts III, V and VII.		

SLIDING DOORS—

Lock	Single, . . . . .	1704 <sup>1</sup> / <sub>2</sub>	1704 <sup>1</sup> / <sub>2</sub>	1704 <sup>1</sup> / <sub>2</sub>
	Double Flat, . . . . .	1704	1704	1704
	Double Astragal, . . . . .	1724	1724	1724
Trim, as desired, . . . . .	See Parts III, V and VII.			

DOUBLE DOORS—

SINGLE FOLD—

Butts, . . . . .	750	780	47
Bolts, . . . . .	188	184	184
or Two Bolts, . . . . .	383	383	383
“ “ . . . . .	283	481	2715

Locks, Flat or Rabbeted, as desired.

Trim, as desired, . . . . . See Parts III, V and VII.



## INSIDE DOORS—Continued.

DOUBLE DOORS—Continued	Best.	Medium.	Common.	
DOUBLE FOLD—				
Trim as for "Single Fold" except				
Folding Leaf	{ Butts, . . . . .	350	785	147
	{ Bolts, . . . . .	283	481	2715
Active Leaf	{ Cup—One Side, . . . . .	800	800	800
	{ or Drop Ring Handle, . . . . .	1094	1094	1094
ELEVATORS—				
Sliding Door Lock, . . . . .	1792	1792	1792	

LINEN CLOSETS—See Closets, page 1049.

MEDICINE CLOSETS—See Cabinets, page 1051.

## SLIDING DOORS—

Lock	{ Single, . . . . .	1706 <sup>1</sup> / <sub>2</sub>	P3912 <sup>1</sup> / <sub>2</sub>	SB3912 <sup>1</sup> / <sub>2</sub>
	{ Double Flat, . . . . .	1706	P3924 <sup>1</sup> / <sub>2</sub>	SB3924 <sup>1</sup> / <sub>2</sub>
	{ Double Astragal, . . . . .	1726	P3936 <sup>1</sup> / <sub>2</sub>	FB3936 <sup>1</sup> / <sub>2</sub>
Latch	{ Single, . . . . .	P1902 <sup>1</sup> / <sub>2</sub>	P1902 <sup>1</sup> / <sub>2</sub>	FB1902 <sup>1</sup> / <sub>2</sub>
	{ Double Flat, . . . . .	P1904 <sup>1</sup> / <sub>2</sub>	P1904 <sup>1</sup> / <sub>2</sub>	FB1904 <sup>1</sup> / <sub>2</sub>
	{ Double Astragal, . . . . .	P1905 <sup>1</sup> / <sub>2</sub>	P1905 <sup>1</sup> / <sub>2</sub>	FB1905 <sup>1</sup> / <sub>2</sub>
Pull only, . . . . .	68	68	68	
Trim, as desired, . . . . .	See Parts III, V and VII.			

SLOP SINK CLOSETS—See Closets, page 1049.

## WINE CELLARS—

Butts, . . . . .	780	47	239
Latch, . . . . .	344	66	042

## WATER CLOSET STALLS—

## WITH MARBLE PARTITION—

Spring Butts, as desired.

Indicator Bolt,	{ Mortise, . . . . .	1087	1087	1087
	{ Rim, . . . . .	1086	1086	1086
Strike for above, . . . . .		1111	1111	1111
or Slide Bolt, . . . . .		1075	1075	1075
or Knob, . . . . .		1780	1780	1780
Knob Bolt Strike, . . . . .		1111	1111	1111
or Knob Lock, . . . . .		1784	1784	1784
Knob Lock Strike, . . . . .	Special.	Special.	Special.	Special.
or Bar Latch, . . . . .	1076	1076	1076	

INSIDE DOORS—Continued.

WATER CLOSET STALLS—Continued—

WITH MARBLE PARTITION—	Best.	Medium.	Common.
Door Pulls, . . . . .	43	201	215
Coat Hook: for marble, . . . . .	1603	413	513

WITH WOOD PARTITION—

Same as above, except regular Strikes and Wood Screws throughout.

YACHT CABINS—

Sliding Door Lock, . . . . .	1876	1876	1876
Trim, as desired, . . . . .	See Parts III, V and VII.		

MISCELLANEOUS DOORS.

ASYLUMS—

See Asylum Locks, page 218.

BOOKCASES—

Butts, . . . . .	160	150	289
Bolts, if desired, . . . . .	1175	1175	1175
Locks, . . . . .	PA150	PA150	PA150
Keys and Key Plates, as desired, . . . . .	See pages 678 and 952.		
Hinge Plates, if desired.			

BUFFETS—

Butts, . . . . .	785	147	289
Latch, . . . . .	917	917	917
Hinge Plates, if desired.			

CABINETS—

Butts, . . . . .	160	160	241 1/2
Cupboard	} Locks, . . . . . PA75	. . . . .	. . . . .
Turn, . . . . .			

CARRIAGE WAYS—

Sliding Door Lock, . . . . .	304S	344S	344S
------------------------------	------	------	------

COAT ROOM—

GATE AND COUNTER LID—

Hinges (For Gate) . . . . .	750	750	750
Butts (For Lid), . . . . .	150	150	150
Latch, . . . . .	66	66	66
Elbow Catch, . . . . .	1193	1193	1193
Roller Support, . . . . .	Special.	Special.	Special.

CUT-OUT BOXES—

Butts, . . . . .	160	150	291 1/2
Lock, . . . . .	PA150	PA150	PA150
Keys and Key Plates, as desired, . . . . .	See pages 678 and 952.		

## MISCELLANEOUS DOORS—Continued.

	Best.	Medium.	Common
<b>HOTELS—GUEST ROOM DOORS—</b>			
Locks, . . . . .	See pages 641 to 644		
Butts, . . . . .	750	780	47
Trim, as desired. . . . .	See Parts III, V and VII.		
<b>JIB HEAD DOORS—</b>			
Butts, . . . . .	750	780	47
Bolts (Lower pair), . . . . .	188	283	383
“ (Upper pair), Cross Bolts and 2 Upper Bolts. . . . .	Special for hook	283	383
Hooks, . . . . .	1358	1358	1358
Angle pieces (Brass), if desired, .	Special	Special	Special
Locks, as desired.			
Trim, as desired.			
<b>LOCKERS—</b>			
Butts, . . . . .	785	147	150
Locks, . . . . .	6000	533	510
Coat Hooks, . . . . .	413	413	2413
<b>OFFICES, CORRIDOR DOORS—</b>			
Butts, . . . . .	750	780	47
Locks (Cylinder type), . . . . .	6614	654	660
“ (Lever tumbler type), . . . . .	1442	1500	P2918 $\frac{3}{4}$
Latches (Cylinder type), . . . . .	6274	790	790
“ (Hinged bolt), . . . . .	656H	770H	770H
Letter Hole Plate, . . . . .	1505	1507	745
“ “ “ with Hood . . . . .	1506	1508	747
Door Check (Blount), if desired, .	See pages 786 to 788		
Trim, as desired.			
<b>OFFICE GATES—</b>			
Hinges, as desired.			
Latch: Secret, . . . . .	4310	4310	4305
<b>PANTRY DRESSERS—</b>			
Butts, . . . . .	780	47	241 $\frac{1}{2}$
Cupboard Turns, . . . . .	1089	500 $\frac{1}{2}$	2500 $\frac{1}{2}$
Catches, Elbow, . . . . .	1191 $\frac{1}{2}$	2191	2191
Brass Track, as required.			
Brass Sheaves, as required.			

MISCELLANEOUS DOORS—Continued.

PRISON LOCKS—See page 219. Best. Medium. Common.

SAFE LOCKS—See page 220.

SAFE DEPOSIT LOCKS—See page 222.

SECRET DOORS—

Walking Beam Pivot, . . . . . Special. Special. Special.

Latch: Secret, . . . . . “ “ “

Operated on One Side or Both, by Push Button on Floor or in Casing.

SHUTTERS—

Sliding Lock, complete, . . . . . 1708 1708 1708

SUB-TREASURY LOCKS—See pages 223 and 674.

WARDROBES—

Butts, . . . . . 750 780 47

Bolts (if double doors) . . . . . 280 480 480

Locks, { Flush Rim, . . . . . 1785 line 1785 1785

{ Mortise, . . . . . 1644 “ 1644 1644

{ Cabinet, . . . . . PA150 PA150 PA150

Hooks, as desired . . . . . See pages 794 and 795

Trim, as desired, . . . . . See Part VIII.

WINDOWS.

BOX HEAD WINDOWS—

Sash Lift and Lock { Flush, . . . . . 1349L 1344L W1400

{ Hook, . . . . . 1339 1339 1339

Sash Lock { Rim, . . . . . 912 912 912

{ Mortise, . . . . . 914 914 914

DOUBLE HUNG WINDOWS—

Sash Fast, . . . . . 1377 1372 W1400

Sash Lift { Flush, . . . . . 1349 W7349 W1324

{ Hook, . . . . . 91 1342 W5343

Sash Pull, . . . . . 1362 201 215

Sash Sockets, . . . . . 412 410 2400

Sash Bead Screws and Washers, . . . . . 8 8 8

Sash Pole Hook, . . . . . 1358 1358 2358

DOUBLE HUNG WINDOWS, WITH TRANSOM BAR—

For Top Sash Opening Down, . . . . . 1353 or 1354 1354

For Bottom Sash Opening Up, . . . . . 1349L 1344L 1339

Sash Pole Hook, . . . . . 1358 1358 2358

## WINDOWS—Continued

FRENCH CASEMENTS, DOUBLE—	Best.	Medium.	Common.
WITH JAM JOINT—			
Butts, . . . . .	750	780	47
Bolt—Cremorne, . . . . .	893	893	893
WITH RABBETED JOINT—			
Butts, . . . . .	750	780	47
Bolts, . . . . .	280	480	2715
Bolt—Cremorne, . . . . .	893	893	893
Adjusters, . . . . .	1395	1386	2386
or			
Omit Flush Bolts and use Two			
Cremorne Bolts, . . . . .	893	893	893
or			
Use Flush Bolts, . . . . .	283	481	2715
and			
Locking Top, Bottom and Centre,	384	384	384
or			
Flush Bolts, . . . . .	283	481	2715
and			
Mortise Espagnolette Bars, . . .	183	183	183
or			
Rim Espagnolette Bars, . . . . .	881	881	881
or			
Turnbuckles, as desired, . . . . .	See pages 816 and 817		
FRENCH CASEMENT, SINGLE—			
Similar to above, but omitting Flush Bolts			
HINGED WINDOWS—			
AT SIDE OPENING OUT—			
Butts, . . . . .	350	785	147
Turnbuckles, as desired. . . . .	See pages 816 and 817		
Adjusters, . . . . .	See pages 778 to 781		
AT SIDE OPENING IN—			
Butts, . . . . .	750	780	47
Turnbuckles, as desired. . . . .	See pages 816 and 817		
Adjusters, ( For Sill, . . . . .	1393	1393	1393
( For Flush Trim, . . . . .	1394	1394	1394
AT TOP OPENING OUT—			
Butts, . . . . .	350	785	147
Adjuster and Fastening, . . . . .	1388	1388	1388

WINDOWS—Continued.

HINGED WINDOWS—Continued.	Best.	Medium.	Common.
<b>BASEMENT OR CELLAR—</b>			
Butts, . . . . .	785	147	Steel.
Buttons on Plates, . . . . .	Brass.	Brass.	Japanned.
Hooks and Eyes, . . . . .	“	“	Bright Wire.
or Bolts in place of Buttons, . . . . .	1680	1680	Japanned
<b>11B WINDOWS TO PORCH—</b>			
Same Trim as for Double Hung Windows			
also			
Butts, . . . . .	750	780	47
Bolts, . . . . .	280	280	280
Latch, . . . . .	1008	1008	500½
Trim, as desired (one side only).			
<b>PIVOTED WINDOWS—</b>			
Pivots, { Rabbeted, . . . . .	1335	1345	1345
{ Flat, . . . . .	1355	1355	1355
Turnbuckles, as desired. . . . .	See pages 816 and 817		
Adjusters, as desired. . . . .	See pages 778 to 781		
Catches, as desired. . . . .	See pages 782 to 785		

DRAWERS.

<b>DESK OR TABLE—</b>	
Lock, as desired, . . . . .	See pages 674 to 678
Key and Key Plate, as desired. . . . .	See pages 678 and 952
Drop Drawer Handles or Pulls. . . . .	See pages 925 to 939
or	
Knobs, { Glass, as desired. . . . .	See pages 947 and 948
{ Metal “ “ . . . . .	See pages 796 and 940
<b>LINEN CLOSET—</b>	
Drawer Pulls, as desired. . . . .	See pages 925 to 939
Brass Rollers and Brass Track, if desired.	

MISCELLANEOUS.

<b>DROP LIDS—</b>			
Butts, . . . . .	150	150	150
Stay Arm, . . . . .	1165	1161	1161
Knobs, { Glass, as desired. . . . .	See pages 946 to 951		
{ Metal, “ “ . . . . .	See pages 796 and 940		

## MISCELLANEOUS—Continued

INSIDE SHUTTERS—		Best.	Medium.	Common.
Butts, . . . . .		150	150	150
Flaps, . . . . .		50	50	50
Angle Flaps, to suit details. . . . .		60	60	60
Bars, . . . . .		1382	1384	W230
Knobs, { Glass, as desired. . . . .		See pages 946 and 947		
Knobs, { Metal, “ “ . . . . .		See pages 796 and 940		
TRANSOM LIGHTS—				
PIVOTED—				
Pivots, { Rabbeted, . . . . .		1335	1335	1335
Pivots, { Flat, . . . . .		1355	1345	1345
Transom Lifters, as required. . . . .		See page 813 to 815		
HINGED—				
Butts, . . . . .		785	147	147
Transom Lifters, as required, . . . . .		See page 813 to 815		
or				
Hinges (or Pivots), and				
Transom Catches, . . . . .		1186	1187	2605
Transom { Chains, . . . . .		1332	1332	1332
Transom { or				
Transom { Stays, . . . . .		1165	1161	1161
WINDOW SEATS--				
Butts, . . . . .		150	150	150
Catch, . . . . .		1092	1092	1092

## Part X.

### Miscellaneous Information.



# Part X.

## Miscellaneous Information.

Section.	Page.
1. Selecting Hardware, . . . . .	1059
2. Allowance for Finishing Hardware, . . . . .	1063
3. Detail Drawings for Hardware, . . . . .	1064
4. Hints to Salesmen for "Taking Off" Hardware, . . . . .	1066
5. The Hardware Expert, . . . . .	1069
6. The Province of the Builder, . . . . .	1071
7. Factory Lock Equipment, . . . . .	1073
8. Lever Handles for Locks, . . . . .	1074
9. Glass Trim, . . . . .	1075
10. Special Key Bows, . . . . .	1076
11. Key Tags for Hotel Use, . . . . .	1077
12. Frictional Sash Fast, . . . . .	1079
13. Door Locks of the "Unit" Type, . . . . .	1080
14. Casement Window Construction, . . . . .	1082
15. Weight of Sashes (and Glass), . . . . .	1088
16. The Care of Locks, . . . . .	1090
17. The Care of Hardwood Floors, . . . . .	1091
18. Grammatical Propositions, . . . . .	1093

## Section 1.

### Selecting Hardware.

**N**O other material entering into the construction of a building will pay a larger return, in satisfaction, comfort and permanent economy, for time and care devoted to its selection than the "Finishing Hardware," but until lately none has had less consideration. The range of choice and quality has become too great, however, for the selection of Builders' Hardware any longer to be left to the general contractor under an omnibus specification, and the practice is fast becoming universal of according to it the benefit of careful and discriminating selection, by the architect or the client, or by both in consultation. And this holds good as to the many mechanical questions involved, as well as to those which relate purely to decorative effects; in both the architect's judgment, based on fuller technical knowledge, must be qualified by the client's preference and taste, or by the limit of cost which he imposes, except in those cases, unfortunately rare, in which the Architect is given *carte blanche* to do what he thinks best.

Hardware has become a factor, and an important one if well handled, in the interior ornament of the modern building, and its selection demands at least equal care with that given to other elements of interior decoration, such as lighting and mantel fixtures, wall papers, hangings, etc., all of which have always been the object of personal selection by architect or client, and are never merged in the general contract for construction.

The method which should be employed in all these matters depends primarily on the conditions. If the building in question

is intended for sale or renting, or if *cheapness* is the dominant factor, then a competitive method may be expedient; but if the client intends it for personal occupancy or for permanent ownership, then the competitive method may, and usually is, a poor one whereby to secure the best result. The desirable method in *all* cases is that a preliminary examination should be made, before any final decisions are reached, in order that both architect and client may have an intelligent general knowledge of the subject and of the range, in quality and prices, of the material available for selection. This accomplished, a decision can then be made as to the *grade* of Hardware to be used in the various parts of the building, and this decision will greatly simplify all the rest of the work. Broadly speaking, Finishing Hardware divides into three grades, viz: Cheap, Medium and Fine, as explained in Part III, Section 3, and by deciding upon one of these the process of selection in any case is greatly facilitated by the resulting elimination of all articles outside of the grade selected.

Whatever the method used, or the grade selected, preference can safely be given, in all cases, to the product of a manufacturer of known experience and established reputation. No matter how great the care and intelligence devoted to personal selection, the choice is limited absolutely to what the manufacturers see fit to provide, and is larger, of course, in proportion to the extent and variety of the line made by each. Where one manufacturer fully covers the whole field, and especially where his product is of known reliability and wide range, it is usually found advantageous to use the same make of goods throughout the building, rather than to select goods of different makes, and this practice increasingly obtains. The contrary practice tends to confusion and errors, to lack of harmony in style and in finishes, and to a division of responsibility which is undesirable.

Having decided on the *grade* of Hardware, the next step should be, preferably, a decision as to the Manufacturer from whose line it shall be selected in detail. The decision as to this is usually left to the architect, whose previous experience generally enables him to decide promptly which of the several lines available is the one to be preferred in the case under consideration. When this point is in doubt the catalogues of the manufacturers can be consulted or, still better, the samples of their work, to be seen in their several exhibit rooms and in those maintained by dealers who handle their products, may be inspected. It is now the general practice for each dealer to carry chiefly in stock the line of some one manufacturer, and this practice is based on sound reasoning, but no difficulty need be experienced on this score in obtaining whatever make of goods is desired, as inquiry will always elicit information as to where it is to be obtained.

The question may be asked if this method does not tend to eliminate competition and involve the payment of higher prices than necessary, in reply to which it is pointed out that the prices of the manufacturers, for staple goods shown by catalogue, are already well established, and are known to the trade generally, so that, even if short-sighted enough to desire to take advantage of such a situation, the manufacturers are not in a position which would enable them to do so, and that, if a check on the dealer is thought necessary, it can readily be had by calling for competitive bids from two or more dealers on an identical specification or schedule of Hardware. By this method the architect selects exactly what he wants, and has every assurance of getting what he has selected, whereas, if a mixed assortment of goods is used the process of selection is more difficult and uncertain, and the liability to changes and substitutions greatly increased.

Having thus decided on the maker and the grade of goods, the next step is to select in detail the goods to be used in each room, floor or division of the building, making such notes of the decisions so reached as will be convenient in framing the Hardware specification or the Hardware Schedule, as explained hereafter. These notes can usually be made with advantage in pencil on the plans, and then be incorporated subsequently, in proper form, in specification or schedule.

## Section 2.

---

### Allowance for Finishing Hardware.

**A**RCHITECTS are constantly called on to prepare preliminary estimates on proposed buildings to assist owners in determining their plans. For this purpose there is available knowledge of the cost per unit of masonry, woodwork, etc., which makes it feasible to compute their costs easily and with fair accuracy.

Builders' Hardware does not so readily admit of accurate preliminary estimating, and yet unusually bears a fairly constant ratio to the total cost of buildings of various types. The following figures, based on experience, indicate the range in this ratio under the conditions usually encountered in ordinary practice :

*Ratio of Cost of Finishing Hardware  
to Total Cost of Building, Excluding Land.*

Hotels, large, . . . . .	1.0	to	1.5	per cent.
“ small, . . . . .	1.5	“	2.0	“
Apartment Houses, . . . . .	1.5	“	2.0	“
Office Buildings, . . . . .	.5	“	1.5	“
Public Buildings, . . . . .	1.5	“	2.0	“
Libraries, . . . . .	.75	“	1.5	“
Hospitals, . . . . .	.5	“	1.0	“
Residences, City, . . . . .	1.5	“	3.0	“
“ Country, . . . . .	2.0	“	4.0	“

## Section 3.

### Detail Drawings for Hardware.

**A** PRACTICE prevails in some architect's offices which, at trifling cost, accomplishes most useful results and is worthy of general acceptance. This consists in putting onto one drawing sheet a *full size* cross section of every type of door stile in the building to which the drawing relates, and in furnishing copies of this drawing to the contractors for the cabinet trim and for the Finishing Hardware, thus ensuring that each of them has identical information, and that the work of each will assemble properly with that of the other.

Such drawings should show, as to each door, the dimensions of the transverse section of its vertical stile (which receives the lock and its trim,) the overlapping, if any, of panel moldings, the shape of bevels, rabbets and astragals, and any other details affecting the size and location of locks, butts, etc. The "hand" of doors is usually and better indicated on the floor plans. For the guidance of the *cabinet* contractor the drawing should indicate the veneer, or wood, to be used on each side of the door, and for the guidance of the *hardware* contractor the finish of the metal work, as illustrated by Fig. 1.

Parlor—Mahogany—Gold Plate.

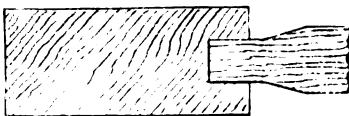

Hall—Oak—Old Brass.

Fig. 1.

All of the questions which such a drawing should answer must be settled sooner or later, and by the architect. If settled in this way they will have due consideration at the

proper time, will usually be settled more carefully than is other-

wise likely, and, above all, will be so settled as to furnish the information to the several contractors concerned when they need it, in a form which precludes misunderstandings among them, and in a manner which will definitely locate the responsibility for any errors should they occur.

A further argument, if one is needed, is that the character and dimensions of metal work and locks are liable to be overlooked when arranging the paneling of doors, whereas both should be considered. The use of very narrow stiles is sometimes resorted to without sufficiently considering the disadvantages which result from the contracted space in which the lock and its trim must be placed. Where a narrow stile is proposed the architect should inform himself as to the locks which are available, and should provide space for the one selected. Special locks are always expensive, and a cramped space precludes the best construction.



## Section 4.

---

### Hints to Salesmen for "Taking Off" Hardware from Architects' Drawings and Specifications.

**I**N view of the fact that the compilation, from the architect's plans and specifications, of the "schedule" of hardware actually required in a given building, is commonly made by the hardware salesmen, the following suggestions are offered for their guidance. It would be better if, as in England, this work were done by a chartered "Quantity Surveyor" whose official "schedule" would form the basis of all bids, and it is to be hoped that this system will ultimately be established here. Until then the reliance of the architect must be on careful and thorough specifications, and on rigid inspection before final acceptance.

A schedule of the hardware for a building must be compiled from the specifications (which indicate the *kinds* of goods to be used) and from the plans (which indicate the number of the openings for which hardware is required, and, therefore, the *quantities* needed of each article.) To do this requires ability to read drawings easily and accurately, and, above all, *thoroughness* in every detail of the work.

The first step should be to study the specifications relating to hardware, and also the portion relating to carpenter work to see if the latter embodies facts which affect the hardware. The drawings should then be examined to gain familiarity with the building, the arrangement of rooms and other details. Having thus acquired a general understanding of the whole subject the compilation of the schedule may be begun.

The list of hardware should be compiled in a systematic manner, beginning at a definite point in the building and progressing through the several rooms and floors in a definite order, which will insure the inclusion of every part of the building and the careful consideration of every opening or other place where hardware is required. For example, in the case of a residence, it is usual to commence with the front entrance, involving the front and vestibule doors, passing thence to the hall, then taking each room on the first floor in due order, then passing to the second floor, taking each room on it in like order, and so on until each floor has been covered. The attic and basement are usually left to the last, because requiring a simpler class of goods. The same general system can be followed in the case of hotels, office buildings, apartment houses, etc., the essential point being that an *orderly method* should be followed, the rooms being taken in natural sequence, so that the chances of omission are minimized.

In the case of doors, it is necessary to state their thickness, hand, bevel or rabbet, number of butts required, and size of butt needed to clear the trim, and the design, metal and finish of the goods to be used, which frequently differ on the opposite side of the same door. In the case of sliding doors, the character of hangers and rail, and the length of run must always be noted. Where the door stile is narrow or is trimmed with heavy mouldings, the backset of the lock must be considered, and care taken to avoid interference between the hardware and the wood work. In the case of windows information is needed as to all details, and like care must be taken to harmonize the metal work and the wood work.

Where unavoidable interferences are discovered, or where the plans and specifications are obscure or defective, a note of the facts should be made, and when all such matters have been

collated they should be submitted to the architect for his decision as a basis for the final determination of the matters involved.

In drafting a schedule the name of each room or other division of the building should form a heading, and under this heading should be grouped all of the openings included in such room or division. Under the name of each opening, in like manner, should be grouped the hardware required therefor. Schedule orders thus prepared should be executed by the manufacturer in exact conformity with the instructions, the hardware for each opening being combined in a separate package and each package clearly labeled to indicate its contents and the room to which it belongs. When received, the packages can then be kept unopened until needed (thus protecting the goods against damage) and, as each room is ready for its trim, the proper packages can be selected and delivered to the carpenters, thus eliminating all trouble, either to the dealer or builder, and insuring the application of each article in its intended location.

## Section 5.

---

### The Hardware Expert.

**M**ODERN industrial art has developed the necessity for professional advisors, specialists and experts in many fields of work. Among these, in the constructive arts, the architect stands in the front rank both in the importance and antiquity of his profession, as does also the engineer, using the word in the broadest sense.

In the arts, as in the sciences, the tendency of the day is constantly toward greater specializing. Modern science and modern art are too vast and comprehensive to be grasped in their entirety by anyone. The process of differentiation and specializing thus developed has already justified itself by demonstrating the fact that it conduces not only to better results but frequently also to better economy.

Unless the expert is intimately familiar with the existing conditions of his art, and fully informed concerning its latest developments, he is not in position to give the best advice or to obtain the best economic result. But to have this latest and fullest knowledge in any one of the important lines of industrial art implies that the possessor must be himself a worker therein, and this in turn implies that if he performs this duty well he can do little else.

Architects who are beginning to appreciate the distinction between the Hardware of Ornament and the Hardware of Construction are also beginning to ask how they can obtain the former under conditions which will give them the best result from a given expenditure. Few of them have that latest knowledge of the latest product of the art which is needed to

fit them for this work, and probably none in active practice have the time to devote to it. What then are they to do?

To answer this question, and to meet the want which it implies, there is coming into existence another specialist, namely, the "Hardware Expert," that is, a person trained in the art, knowing all of its present possibilities and familiar with its latest products. Added to these he must have such personal character, and such connections, as will give confidence and assurance to the architect who trusts him that the trust will not be abused. He must have the courage of his convictions so that on the one hand he will not hesitate, when necessary, to curtail expenditure within the limits consistent with due respect for the effect which should result even in the plainest and simplest work, and on the other hand, will not hesitate to insist on a more liberal expenditure in cases where mistaken economy, perhaps in minor matters, involves the danger of subsequent disappointment from incongruous treatment and lack of harmony resulting from unwillingness to authorize the expenditure reasonably needed.

Several of the leading manufacturers, among them the Yale & Towne Manufacturing Company, have provided a corps of trained experts of this kind whose services are placed at the disposal of architects and customers, especially in the selection of the metal work for buildings of the larger and more important kinds.

## Section 6.

### The Province of the Builder.\*

**T**HE relation of the man who builds a house to the man who designs it, and the relations of both to the owner, who is to pay the bills: these are vexed questions which each man tries to settle for himself, and which are, therefore, in what an Irishman would call “a permanently unsettled condition.”

In the first place the owner has an indistinct idea of what he wants, and a very positive idea about how much it ought to cost him, and is also firmly convinced that he knows all about it. He, therefore, engages an architect in order to have the privilege of telling him how to build his house for him, and incidentally also to make the designs and drawings, and superintend things generally.

When it comes to matters of detail the owner supposes that the architect will take care of them; if not, why have one at all? And so, after many changes and much discussion, the drawings are accepted and the specification and contracts prepared. At this stage the owner begins to appreciate the fact that there is a builder in the case, and that his province, after all, is to make the house for him.

Among the three parties there seems often to be an impression in the mind of each that he is really the man who builds the house. The owner talks freely of the house he is building, while the architect does not hesitate to call it his, however much his ideas may have been cut and hacked; and in the meantime the builder goes ahead with the work, and with many portions does pretty much as he pleases.

\*From the Trefail.

The result of this combination is not always satisfactory to any of the three. Of course the owner wants to get the best for the money ; but he doesn't always know just what he does want, and, hence it is the function of the architect to tell him what he wants, and the function of the builder to get it for him, and, furthermore, it is the province of the architect to see that he gets it.

This brings us to the real question in hand, the function of the builder. He is expected to take the contract at the lowest possible figure and to execute it in the best possible manner, and incidentally make a fair margin of profit for himself, he not being in the business from purely philanthropic motives. In carrying out these laudable objects he has his chart, the specification and the drawings, and if he keeps strictly to their limitation he does well. Much of the fault which is found with the builder is uncalled for, either in justice or in the specification, and when the shortcomings which are so frequently denounced, are heard, one is sometimes reminded of the housemaid, who, when reproved for not having divined the intentions of her mistress, retorted : " Did you expect to get a mind reader for three dollars a week ? "

The builder is all right if he is only given a fair chance ; but before he is called in at all the owner and the architect should make up their joint mind as to what they really want, and should say so clearly and unmistakably in specification and drawings. The articles which the owner should himself select ought clearly to be stated as being omitted from the specification and to be furnished when required ; and then, with the addition of a limited amount of common sense, there may be good reason to expect mutual satisfaction, and what is still more desirable, a fairly good building when all is done.

## Section 7.

---

### Factory Lock Equipment.

**T**HE constant increase in the size of factories, and in the number of employees therein, has brought with it a corresponding increase in the need and value of reliable locks, for the protection of property, and for controlling or regulating access to various buildings and departments. These conditions have led to the development of master-keyed locks especially designed for factory use, and to the extensive introduction of the master-key system in industrial establishments.

The works' manager may now equip his plant with a system of locks such that each will have its individual key, controlling that lock but no other ; these locks in turn may be divided into groups, all in each group controlled by a master-key giving access to all locks in that department but no other ; the watchman may carry a master-key passing only such doors as it is necessary for him to open ; and finally all the locks in the entire series may be controlled by a grand master-key, for use only by the executive officers or owners.

The Yale lock, with its high security, master-keyed on the duplex system, is preeminently adapted for these purposes, and has long been in extensive use. For the best results a system of master-keyed locks should be planned by an expert, in consultation with the manager of the works for which intended, and architects are recommended to avail of such expert service for this purpose.



## Section 8.

### Lever Handles for Locks.

THE United States and Canada, following English example, adopted the knob instead of the lever handle for operating door locks, and, as a result, American locks are designed for use with *knobs*. This implies that they are not well adapted for use with lever handles.

The common knob is round, and therefore balanced. Even the oval knob is balanced so far as concerns its relation to the lock mechanism. The lever handle, however, is unbalanced, its weight being entirely on one side of the lock spindle. This implies the need of greater spring power in the lock, not only to resist the unbalanced weight, but also to afford a proper resistance to the hand when applied to the lever handle, the hand in this case acting at much longer radius than in the case of a knob. In Continental Europe, where the use of the lever handle is almost universal, the established practice is to provide a very stiff spring in the lock to give proper support to the lever handle.

Lever handles are coming into use in the United States, not only for French windows and casements, but also occasionally for entrance and other doors. Where used with the ordinary lock they are thoroughly unsatisfactory, the lock spring being too weak to give the proper support to the lever handle. A



Fig. 1.

remedy for this consists in the use of an auxiliary spring, supplementing the spring contained in the lock, and applied to the spindle behind the rose or escutcheon plate as shown by Fig. 1, but the only effective remedy consists in the employment of a lock designed expressly for use with lever handles.

## Section 9.

### Cut Glass Trim.

**G**LASS Knobs have been described on pages 944 to 951, and are available for use with metal Roses, Key Plates and Escutcheons of many styles.



Fig. 1.

In like manner glass is available as the material for Key Plates and Escutcheons, combined with either glass or metal knobs, as shown by the accompanying illustration (Fig. 1) and Fig. 1 on page 522.

Glass is particularly suitable for Push Plates and Finger Plates. Combined with proper metal work it is very effective.

It has long been used for these purposes in France, and merits more consideration here than it has heretofore received, especially in residence work, where it is particularly appropriate. Necessarily glass hardware, except of very simple kinds, must be made to order, and the material lends itself readily to special forms designed to harmon-

ize with the surrounding decorations.

## Section 10.

### Special Key Bows.

**I**N the pockets of the modern man, and often of the modern woman, will be found, *inter alia*, three essentials, a purse, a watch and a bunch of keys, and often the latter is the bulkiest of the three.

By the judicious use of "master-keys," as explained elsewhere, its bulk can often be much reduced, but at best it usually comprises a number of keys, and frequently several of these are of the same type, and, therefore, difficult to distinguish, especially in the dark.

To meet this difficulty it is recommended that important keys, especially the night-latch key, should have a bow of *special form*.



8A



8D



8B



8E



8C

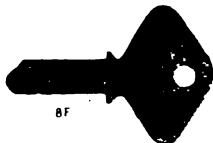

8F

perceptible by touch as well as by sight. The illustrations herewith show various keys with special bows which are available for use with the Yale Locks, and which can be had at slight additional cost.

## Section 11.

### Key Tags for Hotel Use.

**E**VEN the key tag, humble as its function is, has shared in the recent march of improvement, and has taken on new and better forms.

Formerly hotel managers sought to prevent guests from carrying away hotel keys, either through inadvertance or intention, by

attaching to each key a large tag, or iron or brass, so cumbersome as to practically preclude its being carried in the pocket. Happily, this primitive plan is now almost obsolete.

As a result of a tendency to the other extreme, hotel managers largely dispensed with key tags of all kinds, and contented themselves with having the name of the hotel and number of room plainly stamped on the key bow.

The latest and best development in this matter is shown by the accompanying illustrations. It consists in attaching to the key bow, by a short chain, either an ornamental disc bearing the name and number, or else in a simple ball, the name and number being retained on the key bow.



The Waldorf.



The St. Regis.

In either case the short pendant serves convenience in the use of the key, diminishes the danger of its being misplaced, and, if well designed, contributes to its appearance.

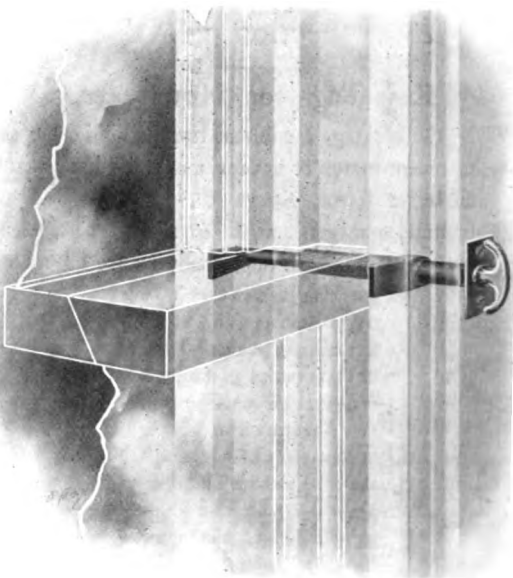

Fig. 1.

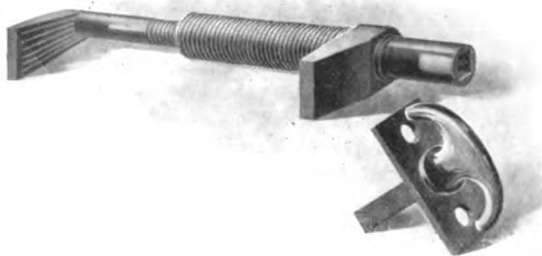

Fig. 2.

## Section 12.

---

### Frictional Sash Fast.

**T**HE requirements of a good Sash Fast of the standard type has been discussed on page 181, and various forms of such Sash Fast are illustrated on page 806.

Recently a Sash Fast of another type has been placed on the market which possesses some advantages over those of the common type. This is a frictional device which, by clamping the two sashes together and against the parting-strip, locks them in any position, open or closed, and at the same time tends to prevent their rattling.

Its construction will be apparent from the accompanying illustrations. The device consists of a metal clamp in two parts, mortised into the window frame, its inner end provided with a socket to receive either a detachable key, or the spindle of a fixed thumb-piece, as preferred. Turning the key or thumb-piece in one direction causes the two lips of the clamp to approach, thus forcing the sashes tightly together. Turning the screw slightly in the other direction releases them. One of these sash clamps to a window will suffice, but a better result is obtained from the use of two, one on either side. They enable the sashes to be firmly locked in any position.

This new device is made by the Yale & Towne Manufacturing Co., and is designated the "Cinch" Sash Clamp.

## Section 13.

### Door Locks of the "Unit" Type.

THE standard "lockset" consists of three elements, viz: (1) the lock, (2) two escutcheon plates, and (3) a pair of knobs, with their connecting spindle, supported by bearings in the escutcheon plates. These elements are not united until placed on the door and permanently attached to it.

Recently a new type of lockset has been introduced, the leading example of which is the Corbin "Unit" Lock, in which all of the elements are permanently united in a metallic construction by the lockmaker, so that the lockset is applied to the door as a *unit* or whole. The construction implies that, instead of cutting a mortise in the door to receive the lock, a section of the door stile must be entirely cut away. Obviously the door stile is correspondingly weakened, but the claim is made that its strength is practically restored by the overlapping of the escutcheon plates, which are firmly screwed to the stile above and below the cut made to receive the lock.

Undoubtedly the consolidation of the component parts of the lockset into a single unit is a mechanical improvement so far as the lock and its trim are concerned, but this improvement is obtained at the sacrifice of a serious impairment of the strength of the door, and also by discarding some of the features in lock construction which experience has shown to be best or most acceptable, and by substituting others, less acceptable, to meet the special conditions created by the "unit" construction. Thus, in the Corbin "Unit" Lock, in order to reduce the size of the lock and thereby minimize the amount of cutting of the door frame, the key-hole is placed in the center of each knob (instead of

above or below it), and a ring or collar on the knob shank is used to control the stop-work of the lock. These features, while simple to one familiar with them, are unfamiliar and puzzling to others, and therefore less generally acceptable and convenient than the standard construction, which is understood by everyone.

If the “Unit” type of lockset proves to be permanently desirable, undoubtedly it will be modified and improved by experience. Probably it will be found preferable to locate the keyhole in its familiar position above or below the knob, and mechanically there is no difficulty in doing so. The increase in the size of the lock case thus involved is vertical, not horizontal, and the additional amount required to be cut out of the door stile does not further weaken the latter. It is too soon yet to forecast the probable trend of public preference in regard to this new type of lockset, but it is safe to predict that, if it is permanently called for, it will be developed on lines which will minimize its objections and will make it mechanically safe and reliable. Artistically it involves features which are objectionable, but which are inherent, especially a projecting lip or flange on one side of the escutcheon plate, which is certainly irrelevant and out of place, from the decorative view-point, especially in the case of an ornamental design.



## Section 14.

---

### Casement Window Construction.

**A**S STATED elsewhere, the Casement Window with hinged sashes, although in universal use throughout continental Europe, is almost unknown in America and but slightly used in England. Believing that American architects, in view of the increasing use of casement windows here, especially in country houses, would be glad to have information concerning the modes of constructing such windows which prevail in the countries where they have been used for centuries, and where experience has developed the best methods for making them weather-tight, the author, during a recent visit to Germany and France, obtained the information embodied in the drawings which are reproduced herewith.

Plate No. 1 (page 1084) shows the construction commonly used in North Germany, where the sashes usually open *outward*. In this case the chief difficulty in making the sash water-tight is at the *top*, whereas, when the sashes open inward this difficulty is greater at the *bottom*. The method of hinging involves the use of a type of butt as yet practically unknown here. It is made of sheet steel, its thin blades being inserted in slots, made in the wood by a special tool, and fastened in place by pins driven through the wood and through holes in the butt, the construction causing the butt to press the sash, when closed, tightly against the window frame. The fastening usually employed is an espagnolette bolt, the ends of which, when rotated, engage with pins set in the frame, or in a neat metal box let into the frame, at top and bottom. The joint of the meeting-rails is of the round, locking type.

Plate No. 2 (page 1085) shows a construction employed in South Germany, including the use of double sashes where desired, the two sashes then being coupled together by a linking device, so that both are operated and secured by a cremorne bolt on the inner sash. These sashes open *inward*, and the joint of the meeting-rails is rabbeted. The butt is of the same construction as in plate No. 1, (page 1084), but the vertical joints of the sash and frame are undercut, thus making them tighter. The two ends of the cremorne bolt move vertically to engage with the keepers at the top and bottom of frame, and a projecting spur engages with a tapered hook to draw the sashes together at the center.

Plate No. 3 (page 1086) shows the construction generally used in Paris, the sashes opening *inward*, and the meeting-rails having an interlocking joint. The method of shaping the hanging-stile enables an ordinary butt to be used, and yet forms an excellent weather-tight joint. The fastening device is either a cremorne or an espagnolette bolt, the latter being preferred in buildings of the better class.

Plate No. 4, (page 1087) shows details of the door construction commonly used in France, and the application therewith of Rim Locks of the French type. It also shows the French method of hanging an inside shutter or blind when used in combination with a casement sash.



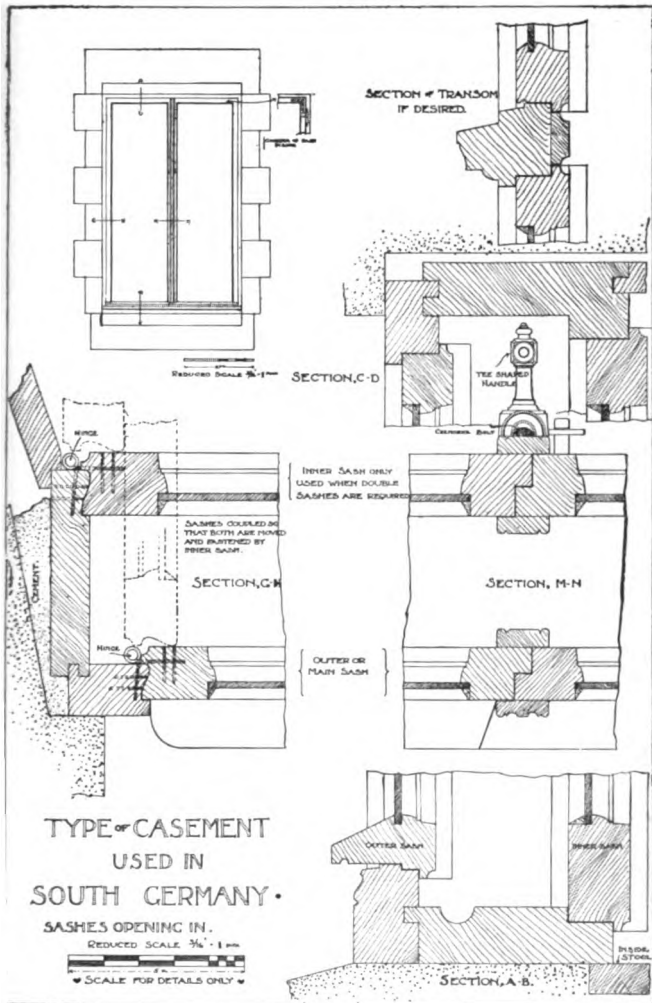

Plate No. 2. South-Germany.

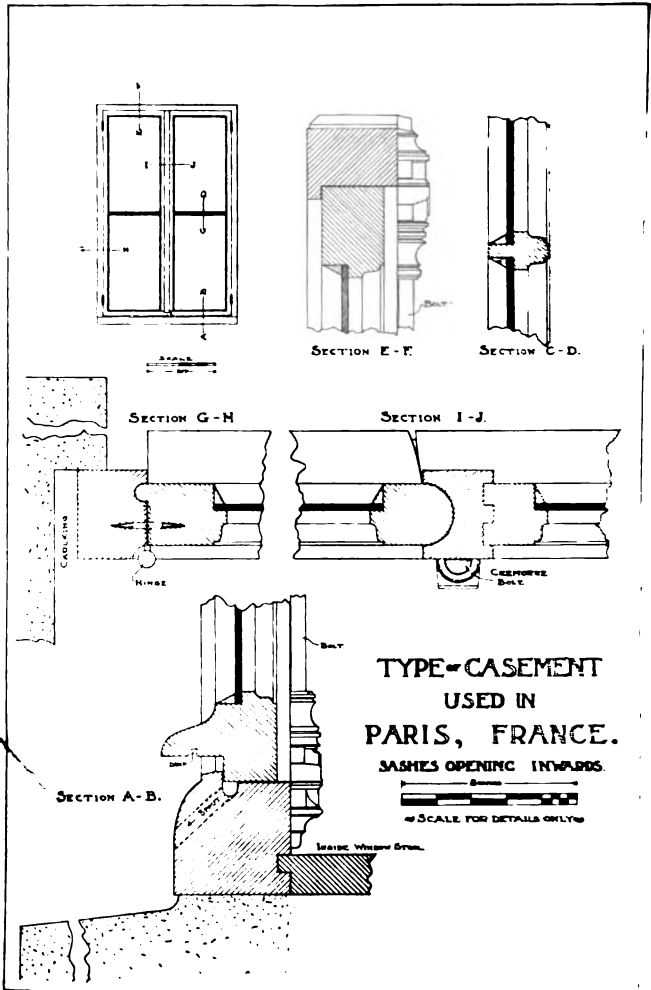
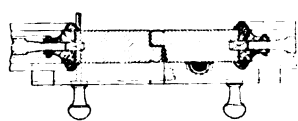
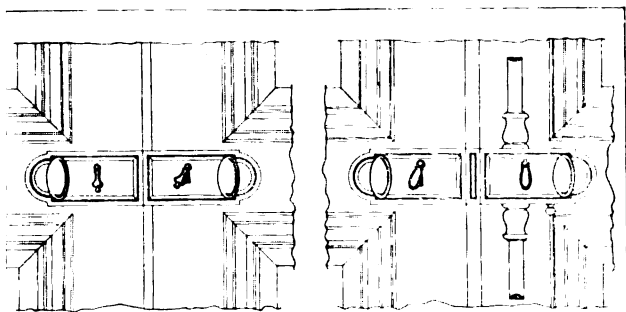
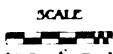

Plate No. 3. France.



ENTRANCE DOORS AND LOCKS



ENTRANCE DOORS AND LOCKS WITH CREMORNE BOLTS

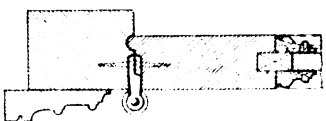
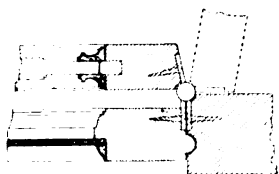

TWIN SASHES WITH 5 LEAF HINGE

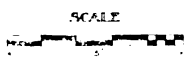

HANGING STILE HINGE

DETAILS OF FRENCH DOOR CONSTRUCTION

## Section 15.

### Weight of Sashes and Glass.\*

**I**N figuring the weight of windows, the weight of the glass may be taken at  $3\frac{1}{2}$  pounds per square foot for plate glass,  $1\frac{1}{3}$  pounds for double thick glass and 1 pound for single thick glass.

For the weight of the wooden sash, add together the height and width of each sash (in feet) and multiply by 2.1 for  $2\frac{1}{4}$  inch sash;  $1\frac{2}{3}$  for  $1\frac{3}{4}$  inch sash, and  $1\frac{1}{3}$  for  $1\frac{3}{8}$  inch sash.

The above data is sufficiently accurate for determining the size of sash cords and pulleys, but the weights should be determined by weighing each sash after it is glazed as the weight of the glass will vary considerably.

**SASH WEIGHTS.**—The weights ordinarily used for balancing windows are made of cast iron, in the form of a solid cylinder,  $1\frac{1}{2}$  or  $1\frac{3}{4}$  inches in diameter, with an eye cast in the upper end. The length varies with the weight.

Ordinary weights have very rough eyes for the sash cords. There are a few manufacturers in the East that make weights with a patent eye that will not cut the cord.

**LEAD WEIGHTS.**—It often happens that for wide and low windows the weights, if of iron, would be so long that they would touch the bottom of the pocket before the bottom sash is fully raised. In such cases lead weights are usually resorted to, lead being eighty per cent. heavier than cast iron. By casting the weights square, whether of iron or lead, considerable saving can be made in the lengths.

\*From "Building Construction and Superintendence"; by F. E. Kidder.

The United Lead Works and the National Lead Works of New York make a specialty of compressed lead sash weights. These weights are made with wrought and malleable iron fastenings centered so that the weight will hang perfectly plumb. When lead weights are necessary it is expedient for the architect, where possible, to specify their weights.

In hanging the sashes the weights for the upper sash should be about one-half pound heavier than the sash, and for the lower sash one-half pound lighter.



## Section 16.

### The Care of Locks.

**L**OCKS, like other pieces of mechanism, need reasonable care and attention to keep them in their best condition. They contain moving parts, and this implies friction, wear and need of occasional lubrication.

The chief point of friction is the beveled latch bolt, and this is easily lubricated. All that is needed is to clean its face and back with a cloth moistened with naphtha or kerosene, to remove any dirt, and then to wipe these surfaces with another cloth saturated with sewing machine oil, or still better with vaseline, thus renewing the lubrication. Any house servant can do this simple work, and if done once or twice a year it will keep the bolts in good condition at all times, so that each door will close easily and quietly.

Another external cause of trouble heretofore has been the tendency of the old-fashioned knob-screw to loosen, and the knob to come off. The advent of the "screwless" knob and spindle, of which the "Triplex" knob is a good example, is eliminating this defect from modern buildings, but where the old style knobs, with side screw, are still in use it is a good plan to inspect them occasionally, and to tighten all loose screws, although a more radical remedy is to replace them with screwless knobs.

Undoubtedly the best result in these matters will be reached by having all locks and hardware inspected by a *lock expert* at regular intervals, say once a year, and the trifling expense thus entailed will be amply repaid by the increased comfort and by the avoidance of other expense for repairs.

## Section 17.

---

### The Care of Hardwood Floors.

**F**OR finishing hard wood floors two methods are in common use. One consists in treating the floor with an approved "filler," and then applying a varnish. Necessarily this process is beyond the scope of household practise, and must be done by painters.

The other process, usually preferred, is that known as waxing, which is easily available for domestic use. The following directions for waxing, which have been approved by long practise, may be of interest.

Use pure yellow beeswax, diluted with spirits of turpentine. Melt the beeswax in a tin pot, placed within another vessel containing water, adding enough turpentine to make the mixture, when hot, about as fluid as rich milk. Be careful not to overheat or to place the pot directly on the stove, as the turpentine is inflammable. Keep it warm while using by standing in a vessel of hot water or on a hot stand of iron.

The floor, when waxed, should be clean and perfectly dry. Apply the wax with a thick, flat painter's brush, about six inches wide, with bristles three or four inches long. Cover about one square yard quickly with the brush and then immediately rub the wax well into the floor with a bunch of oakum in each hand, (soft rags will do, but oakum is better). When the wax has been thoroughly rubbed in, then treat another square yard in the same manner, and continue thus until the whole floor is covered.

Finally, polish the whole floor with a stiff brush, which

should have a surface about nine by twelve inches, and short, stiff bristles thickly set. This brush must be loaded with a stone or iron weight of at least 25 pounds. It should have a short wooden handle pivoted to the back of the brush, so that the whole can be swung back and forth across the floor by means of the handle.

By rubbing a little dry wax on the brush, and going over the floor with it once a week, the floor can be kept bright and clean.

A floor will need to be rewaxed every six to twelve months, according to amount of use. New floors will need it more frequently. No water should be used on a waxed floor; it may be swept or dusted with a fine brush or cloth. Black spots (due to dust gathered by the wax) can be washed out with clear turpentine and the surface then rewaxed.

#### DIRECTIONS FOR OILING HARDWOOD FLOORS.

FOR KITCHENS, HALLS, ETC.

To make one gallon of the oiling mixture, combine the following ingredients ;

3 quarts of raw linseed oil.

1 1/2 pints of turpentine.

1/2 pint of liquid dryer.

2 ounces raw umber, ground in oil.

The umber gives a pleasing color to the finish, but may be omitted if desired.

The floor must be perfectly free from wax, varnish or paint, and must also be clean and dry.

Apply the oil finish freely with a large, flat brush, and then rub thoroughly into the wood with waste or oakum. In rubbing use large pieces of waste or oakum, in each hand, and bear on heavily while moving over the floor. Be very careful to remove and burn the waste or oakum when through with it to avoid danger from spontaneous combustion.

## Section 18.

---

### Grammatical Propositions.\*

**T**HE Decorative Arts arise from and should properly be attendant upon architecture.

Construction should be decorated. Decoration should never be purposely constructed.

All ornament should be based upon a geometrical construction.

The principles discoverable in the works of the past belong to us ; not so the results. It is taking the end for the means.

True beauty results from that repose which the mind feels when the eye, the intellect and the affection are satisfied from the absence of any want.

As in every perfect work of architecture a true proportion will be found to reign between all the members which compose it, so throughout the Decorative Arts every assemblage of forms should be arranged on certain definite proportions ; the whole and each particular member should be the multiple of some simple unit.

\* From "A Grammar of Ornament" by Owen Jones.

## General Index.

For Numerical Index see page 1104.

For Ornamental Hardware arranged alphabetically by *Designs* see page 244,  
and by *Schools* see page 236.

Description.	Pages.	Description.	Pages.
<b>A</b>			
Adjusters, Casement . . . . .	778-781	Bevel of Doors . . . . .	163-167
Allowance for Finishing Hardware . . . . .	1063	Bit of History, A. . . . .	65-70
Apartment House Letter Boxes . . . . .	800	Blank Forms, Specifica- tions, etc. . . . .	994-1056
Architect and Client . . . . .	230	Blount Door Check and Spring . . . . .	-86--88
Art Metal Work and Or- nament . . . . .	226-612	Bolts, Barrel: Plain . . . . .	-63
Artist and Artisan . . . . .	57-64	“ “ Ornamental . . . . .	236-581
Artistic Hardware . . . . .	45-56	“ Bar Slide . . . . .	820
Asylum Locks, Descriptive “ “ and Latches . . . . .	218 672-673	“ Chain: Plain . . . . .	764
Auxiliary Spring Attach- ment for Lever Handles . . . . .	793	“ “ Ornamental . . . . .	236-581
<b>B</b>		“ Cremorne: Plain . . . . .	887-888
Bank and Safe Locks . . . . .	220-223	“ “ Ornamental . . . . .	887-888
Bar Sash Lifts: Plain . . . . .	807	“ Cupboard: Plain . . . . .	782-784
“ “ “ Ornamental . . . . .	236-581	“ “ Ornamental . . . . .	236-581
“ Slide Bolts . . . . .	820	“ Door: Plain . . . . .	630-632, 761
Barrel Bolts: Plain . . . . .	763	“ “ Ornamental . . . . .	236-581
“ “ Ornamental . . . . .	236-581	“ Espagnolette: Plain . . . . .	771
Bars, Shutter: Plain . . . . .	812	“ “ Ornamental . . . . .	883
“ “ Ornamental . . . . .	236-581	“ Extension: Plain . . . . .	765-768
Bell Pulls: Plain . . . . .	763	“ “ Orna. . . . .	236-581, 833
“ “ Ornamental . . . . .	236-581	“ “ Dble. Mortise . . . . .	767-768
		“ Flush: Plain . . . . .	769-771
		“ “ Ornamental . . . . .	236-581
		“ Foot: Plain . . . . .	764
		“ “ Ornamental . . . . .	236-581
		“ Indicator . . . . .	815
		“ Necked . . . . .	761

Description.	Pages.	Description.	Pages.
<b>B—Continued.</b>			
Bolts, Sash . . . . .	809	Catches, Screen Door . . . . .	783
“ Square . . . . .	763	“ Transom : Plain. . . . .	783
Book Case Fasteners . . . . .	784	“ “ Orna. . . . .	236-581
Builder, The Province of the . . . . .	1071	Ceiling Hooks . . . . .	795
Builders' Locks, Grades of . . . . .	117-120	Cellar Sash Fasteners . . . . .	809
Butts, Descriptive . . . . .	173-178	Chain Bolts : Plain . . . . .	764
“ Cabinet : Plain . . . . .	773	“ “ Ornamental . . . . .	236-581
“ “ Ornamental . . . . .	961-991	“ Door Fasteners . . . . .	782
“ Fast Joint Surface . . . . .	774	“ Transom . . . . .	812
“ Loose Joint . . . . .	774	Chest Locks . . . . .	677
“ “ Pin : Plain . . . . .	776-777	Cigar and Newspaper Holders . . . . .	820
“ “ “ Orna. . . . .	236-581, 919	Clamp Hinges . . . . .	819
“ Shutter : Plain . . . . .	772	Closet Door Lock-sets : Plain . . . . .	687-693
“ “ Ornamental . . . . .	236-581	“ “ Lock-sets : Orna. . . . .	715-721
Butt Tips : Ornamental . . . . .	918	“ Latches . . . . .	820
<b>C</b>		Coat and Hat Hooks : Plain . . . . .	794-795
Cabinet Butts : Plain . . . . .	773	“ “ “ “ Orna. . . . .	921
“ “ Ornamental . . . . .	961-991	Combined Cylinder Plates and Ring Pulls . . . . .	876
“ Locks, Descriptive . . . . .	216	“ Escutcheon and Hinge Plates . . . . .	868-869
“ “ Drawer, etc. . . . .	674-678	“ Escutcheon and Kick Plates . . . . .	872
“ “ Key Blanks . . . . .	678	Communicating Door Lock- sets : Plain . . . . .	695
Card Frames . . . . .	792	“ Door Lock- sets : Orna. . . . .	723
Care of Hardwood Floors . . . . .	1091	Contracts, Forms of . . . . .	1012-1021
“ of Locks, . . . . .	1090	Corner Plates . . . . .	847-866
Caseament Adjusters . . . . .	778-781	Corridor Door Lock-sets : Plain . . . . .	687-693
“ Trim, Descriptive . . . . .	185-188	“ “ “ Orna. . . . .	715-721
“ Window Construction . . . . .	1080	Cremorne Bolts : Plain . . . . .	887-888
Catches, Cupboard : Plain . . . . .	782	“ “ Orna. . . . .	887-888
“ “ Orna. . . . .	236-581		
“ Elbow . . . . .	784		
“ French Window : Plain . . . . .	784		
“ “ Window : Orna. . . . .	236-581		

Description.	Pages.	Description.	Pages.
C—Continued.			
Cupboard Bolts : Plain . . .	782,784	Door Springs, Checks and Stops, Descriptive . . .	201-206
“ “ Ornamental . . .	236-581	“ Stops . . . . .	790-791
“ Catches : Plain . . .	782	Double Acting Hinges, De- scriptive . . . . .	199-200
“ “ Ornamental . . .	236-581	Drawer Knobs : Plain . . .	796
“ Locks . . . . .	674-675	“ “ Orna. . . . .	940,961-991
“ Turns : Plain . . .	785	“ “ Glass . . . . .	94-
“ “ Ornamental . . .	236-581	“ Locks . . . . .	675-6-6
Cup Escutcheons : Plain . . .	706-707	“ Pulls : Plain . . . . .	938-939
“ “ Ornamental . . .	904-906	“ “ Orna. . . . .	925-937-D
Cut Glass Knobs . . . . .	944-951	Drop Drawer Pulls : Plain . . .	938-939
Cylinder and Pin-Tumbler Locks, Descriptive . . .	137-138	“ “ “ Orna. . . . .	925-937-D
Cylinders and Rings : Orna. . .	924	Duplex Dead Locks . . . . .	668
D		“ Night Latches . . . . .	66-
Dead Locks : Duplex . . . . .	668	“ Office “ . . . . .	669
“ “ Mortise . . . . .	628-630	“ “ Locks . . . . .	669
“ “ Rim . . . . .	617-618	“ Sliding Door Latches . . . . .	668
“ “ Sash . . . . .	809	Dutch Door Trim, De- scriptive . . . . .	145-146
Designs, alphabetically . . . . .	244	E	
“ by Schools . . . . .	236	Elbow Catches . . . . .	784
Desk Locks . . . . .	676,678	Elevator Sliding Door Latches . . . . .	648
Detail Drawings for Hard- ware, Descriptive . . . . .	1064	Emblematic Hardware . . . . .	582
Door Bolts, Descriptive . . . . .	179-180	Escutcheon Plates : Plain . . . . .	703-705
Doors, Hand and Bevel of . . . . .	163-167	“ “ Orna. . . . .	236-581
Door Check and Spring : . . . . .	786-788	“ and Hinge Plates, . . . . .	868-869
“ Fasteners, Chain . . . . .	782	“ and Kick Plates . . . . .	8-
“ Knobs, Glass . . . . .	944-951	“ Plates & Ring Pulls . . . . .	8-6
“ Metal : Plain . . . . .	708-709	“ Cup : Plain . . . . .	906
“ “ “ Orna. . . . .	236-581	“ “ Orna. . . . .	904-906
“ Wood . . . . .	709	Espagnolette Bolts : Plain . . . . .	771
“ Knockers . . . . .	873	“ “ Orna. . . . .	888
“ Pulls : Plain . . . . .	827-828	Examples of Specifications . . . . .	1022-1044
“ “ Ornamental . . . . .	823-829		

Description.	Pages.	Description.	Pages.
<b>E—Continued.</b>			
Extension Bolts : Plain . . . . .	765-768	Front Door Locks :	652-663
“ “ Orna. 236-581, 888		“ “ Lock-sets : Plain	683
<b>F</b>		“ “ “ Orna.	711
Factory Lock Equipment . . . . .	1073	<b>G</b>	
Fast Joint Butts : Plain . . . . .	775	Gate Fixtures : Leeds . . . . .	810
“ “ “ Orna. . . . .	236-581	“ Latches : Secret . . . . .	616
“ “ Surface Butts . . . . .	774	Glass Knobs : Cut . . . . .	944-951
Fasteners, Bookcase . . . . .	784	“ “ Door . . . . .	944, 945
Figures . . . . .	880-884	“ “ Drawer . . . . .	947
Finishes, Nomenclature of . . . . .	609-612	“ “ Pressed . . . . .	945-951
“ “ Standard ” . . . . .	612	“ “ Shutter . . . . .	946-947
Finishing Hdw., Allowance . . . . .	1063	“ Trim, Descriptive . . . . .	1075
Flaps, Shutter : Plain . . . . .	773	Glossary . . . . .	11
“ “ Orna. 236-581, 922		Grades and Numbers of	
Flush Bolts : Plain . . . . .	769-770	Y. & T. Hardware . . . . .	1045-1056
“ “ Ornamental ] 236-581		Grades of Builders' Locks . . . . .	117-120
“ Pull Sliding Door		Grammatical Propositions . . . . .	1093
Latches . . . . .	648	Grille Doors . . . . .	867
“ Rim Knob Bolts . . . . .	818	<b>H</b>	
“ “ Locks . . . . .	670-671	Hall Tree Hooks . . . . .	794
“ Sash Lifts : Plain . . . . .	808	Hallway Letter Boxes . . . . .	801
“ “ “ Orna. 236-581, 916		Hand and Bevel of Doors . . . . .	163-167
Foot Bolts : Plain . . . . .	764	Handles, Lever : Plain . . . . .	793
“ “ Ornamental . . . . .	236-581	“ “ Orna. . . . .	878-879
Forms of Contracts . . . . .	1012-1021	“ T : Plain . . . . .	792
“ “ Specifications . . . . .	1001-1011	“ “ Orna. . . . .	236-581
Frame Pulleys . . . . .	791	Hardware, Drawings . . . . .	1064
French Hardware . . . . .	589	“ Expert, The . . . . .	1069
“ Window Catches :		“ Emblematic . . . . .	582
“ “ Plain . . . . .	784	“ French . . . . .	589
“ “ Orna. . . . .	236-581	“ Grades and	
Frictional Sash Fastenings . . . . .	1079	Numbers of . . . . .	1045
Front Door Locks : De-			
scriptive . . . . .	142, 143		



Description.	Pages.	Description.	Pages.
H—Continued.		Hotel Keys, Tags for . . .	1077
Hardware, Hints for "Taking Off" . . .	1066	I	
" Mechanics of . . .	103-224	Index : Art Metal Work and Ornament . . .	226
" Orna. 236-581, 734, 735		" Cabinet Hardware . . .	962
" Index by Designs . . .	244	" " Locks . . .	674
" " " Schools . . .	236	" Contents of Parts . . .	5
" Plain . . . . .	762-820	" Hardware Groups . . .	822
" Ratio of Cost . . .	1063	" Locks and Latches . . .	614
" Proprietary . . . . .	586	" Lock-sets : Plain . . .	681
" Selection of . . . . .	1059	" " " Orna. . . . .	681
" Specifications . . . . .	995-1000	" Mechanics of Hardware . . . . .	104
Hardwood Floors . . . . .	1091	" Miscellaneous Information . . . . .	1058
Hat Hooks : Plain . . . . .	794-795	" Narrative and Historical . . . . .	38
" " Ornamental . . . . .	921	" Numerical . . . . .	1104
Hinge and Esc'n Plates . . . . .	868, 869	" Ornamental Hdw. by Designs . . . . .	244
" Corner Plates . . . . .	847-866	" " " " by Schools . . . . .	236
" Corner and Kick Plates, Descriptive . . . . .	207, 208	" Plain Hardware . . . . .	762
Hinges, Clamp . . . . .	819	" Specifications . . . . .	994
" Double Acting, Descriptive . . . . .	199, 200	Indicator Bolts . . . . .	819
History, A Bit of . . . . .	65-70	Inside Door Sets : Plain . . . . .	687-693
Historical . . . . .	89-102	" " " Orna. . . . .	715-721
Hook Sash Lifts : Plain . . . . .	806	K	
" " " Orna. . . . .	236-581	Keys, Descriptive . . . . .	139-141
Hooks, Ceiling . . . . .	795	Key Bows, Special . . . . .	1076
" Coat and Hat . . . . .	794-795, 921	" Plates : Plain . . . . .	705
" Hall Tree . . . . .	794		
" Sash . . . . .	804		
" Towel . . . . .	795		
Hotel Knob Locks . . . . .	641-644		
" Lock-sets : Plain . . . . .	699		
" " Orna. . . . .	727		
" and Office Locks, Descriptive . . . . .	151-158		

Description.	Pages.
K—Continued.	
Key Plates, Ornamental . . . . .	952-956
Kick and Escutcheon Plates . . . . .	872
" Plates: Plain . . . . .	801
" " Orna. 236-581,870,871 . . . . .	
Knob Latches, Mortise . . . . .	622-626
" Locks, " . . . . .	632-644
" " Rim . . . . .	618-621
Knobs, Door. . . . . See Door Knobs.	
" Drawer. . . . . " Drawer " . . . . .	
" Glass . . . . . " Glass " . . . . .	
" Shutter . . . . . " Shutter " . . . . .	
" Thumb . . . . . " Thumb " . . . . .	
" and Spindles, Descriptive . . . . .	168-172
Knockers, Door . . . . .	873-876

L

Latches, Asylum . . . . .	672-673
" Cabinet Door . . . . .	624
" Closet . . . . .	820
" Communicating Door . . . . .	625-626
" Elevator . . . . .	648
" Gate . . . . .	810
" Mortise Knob . . . . .	622-626
" " Night . . . . .	627, 667
" Rim Night . . . . .	615-616
" Secret Gate . . . . .	616
" Screen Door . . . . .	624
" Shutter . . . . .	810
" Sliding Door . . . . .	648, 668, 810
" Store Door . . . . .	664-665
" Vestibule . . . . .	653-663
Leeds Gate Fixtures . . . . .	810
Letter Boxes, Apartment . . . . .	800

Description.	Pages.
Letter Boxes, Club . . . . .	798
" " Hallway . . . . .	801
" " Office Bldg. . . . .	798
" Hole Plates: Plain . . . . .	797
" " " Orna. 236-581,917 . . . . .	
Letters . . . . .	885-886
Lever Handles: Descriptive . . . . .	1074
" " and Plates: Plain . . . . .	793
" " " " Orna. 878-879 . . . . .	
" " Auxiliary Spring . . . . .	793
Lifters, Transom . . . . .	813-815
Lock Boxes: Post Office . . . . .	224
Designing, Evolution in . . . . .	88
Lock-making and Art Metal Work in America . . . . .	39-44
Lock Primer, A . . . . .	105-110
Lock "Trim" and Lock "Sets," Descriptive . . . . .	161, 162
Locks and Latches . . . . .	615-678
" Asylum, Descriptive . . . . .	218
" " . . . . .	673
" Bank and Safe . . . . .	220-223
" Cabinet, Descriptive . . . . .	216
" " . . . . .	674-678
" Care of . . . . .	1090
" Chest . . . . .	677
" Closet Door . . . . .	617-641
" Corridor Door . . . . .	617-641
" Cupboard . . . . .	674, 675
" Cylinder . . . . .	137-138
" Dead, Mortise . . . . .	628-630
" " Rim . . . . .	617-618
" Desk . . . . .	676, 678
" Drawer . . . . .	675-676
" Duplex Dead . . . . .	668
" " Office . . . . .	669
" Flush Rim . . . . .	670-671

Description.	Pages.	Description.	Pages.
L—Continued.		Lock-sets, Plain . . . . .	681-709
Locks, French Window . . . . .	632-633	“ Orna. . . . .	710-731
“ Front Door, Descriptive . . . . .	142-143	“ Glass Knob. . . . .	736, 737
“ Front Door . . . . .	652-663	“ Closet Door: Plain . . . . .	687-693
“ Hotel and Office, Descriptive . . . . .	151-158	“ “ Orna. . . . .	715-721
“ Hotel . . . . .	641-644	“ Communicating Door: Plain . . . . .	695
“ Locker . . . . .	675	“ Communicating Door: Orna. . . . .	723
“ Master-keyed, Descriptive . . . . .	121-126	“ Corridor Door: Plain . . . . .	687-693
“ Mortise Dead . . . . .	628-630	“ “ Door: Orna. . . . .	715-721
“ “ Front Door . . . . .	652-663	“ Front Door: Plain . . . . .	683
“ “ Hotel . . . . .	641-644	“ “ “ Orna. . . . .	711
“ “ Knob . . . . .	632-644	“ Hotel “ Plain . . . . .	699
“ “ Office . . . . .	645-646	“ “ “ Orna. . . . .	727
“ “ Sliding Door . . . . .	649-651, 670	“ Inside Door: Plain . . . . .	687-693
“ “ Store Door . . . . .	664-666	“ “ “ Orna. . . . .	715-721
“ Prison . . . . .	219	“ Office Door: Plain . . . . .	701
“ Residence Use, Descriptive . . . . .	147-150	“ “ “ Orna. . . . .	729
“ Rim Dead . . . . .	617-618	“ Sliding Door: Plain . . . . .	699
“ “ Knob . . . . .	618-621	“ “ “ Orna. . . . .	725
“ “ Store Door . . . . .	617-618	“ S. D. Plain . . . . .	702, 738-743
“ Room Door . . . . .	617-641	“ “ “ Orna. . . . .	730, 744-760
“ Sash . . . . .	809	“ Vestibule Door: Plain . . . . .	685
“ Sliding Door . . . . .	649-651	“ “ “ Orna. . . . .	713
“ Stable Door . . . . .	662	Loose Joint Butts . . . . .	774
“ Sub-Treasury . . . . .	674	“ Pin “ Plain . . . . .	776-777
“ Trunk, Descriptive . . . . .	217	“ “ “ Orna. . . . .	236-281
“ Wardrobe . . . . .	677	<b>M</b>	
“ Wrought Metal, Descriptive . . . . .	127-136	Master-keyed Locks, Descriptive . . . . .	121-126
“ in Sets . . . . .	680-760	Master-keyed Locks . . . . .	667-669
Lock-sets, Index of . . . . .	681	Metals and Finishes . . . . .	595-612

Description.	Pages.
<b>M—Continued.</b>	
Method of Pricing . . . . .	33
Minor Fastenings, Descrip.	196-198
Mortise Aylum Locks . . .	672-673
“ Dead “ . . . . .	628-630
Mortise Door Bolts: Plain	
	630-632, 763
“ “ “ Orna.	236-581
“ Front Door Locks	652-663
“ Hotel Locks . . . . .	641-644
“ Knob Latches . . . . .	622-626
“ “ Locks . . . . .	632-641
“ Night Latches . . . . .	627, 667
“ Office Locks . . . . .	645-647
“ Sliding Door Locks	
	649, 651, 663, 670
“ Store Door Locks	664-666
“ Vestibule Latches	653-663

**N**

Nails and Studs . . . . .	877
Necked Bolts . . . . .	763
Night Latch and Lock, Rim	622
“ Latches, Duplex . . . . .	667
“ “ Mortise . . . . .	627, 667
“ “ Rim . . . . .	615-616
Nomenclature of Finishes	609-612
Numerical Index . . . . .	1104

**O**

Office Latches, Mortise . . .	646-647
“ Locks, Duplex . . . . .	669
“ “ Mortise . . . . .	645, 646
“ Lock-sets: Plain . . . . .	701
“ “ Orna. . . . .	729

Description.	Pages.
<b>P</b>	
Padlocks . . . . .	215
Pivoted Window Trim,	
Descriptive . . . . .	214
Plain Hardware . . . . .	762-820
Plates, Cylinder and Ring	
Pulls combined . . . . .	876
“ Escutcheon: Plain . . . . .	705
“ “ Orna. . . . .	236-581
“ Hinge and Corner: . . . . .	847-866
“ Key: Plain . . . . .	705
“ “ Ornamental . . . . .	952-956
“ Kick: Plain . . . . .	801
“ “ Orna. . . . .	870-871
“ “ and Esc'n . . . . .	872
“ Letter Hole: Plain . . . . .	797
“ “ “ Orn. . . . .	236-581, 917
“ Lever Handle: Plain . . . . .	793
“ “ “ Orna. . . . .	236-581
“ Push: Plain . . . . .	802-803
“ “ Orna. . . . .	236-581, 923
“ Switch . . . . .	920
“ T Handle: Plain . . . . .	792
“ “ Orna. . . . .	236-581
“ Thumb-Piece: Plain . . . . .	792
“ “ “ Orna. . . . .	236-581
Post Office Lock Boxes . . . . .	224
Pricing, Method of . . . . .	33
Prison Locks . . . . .	219
Proprietary Hardware . . . . .	586-588
Province of the Builder . . . . .	1071
Pulleys, Frame . . . . .	791
“ Sash . . . . .	791
Pulls, Drawer: Plain . . . . .	938-939
“ “ Orna. . . . .	925-937
Push Buttons: Plain . . . . .	897
“ “ Orna. . . . .	895-897



Description.	Pages.	Description.	Pages.
<b>S—Continued.</b>		Transom Trim, Descrip.	193-195
Store Door Dead Locks, Rim	617-618	Trim for Special Conditions	209
“ “ Locks, Mortise	664-666	Trunk Locks: Descriptive	217
“ “ Sets: Plain	702, 738-743	T-Handles: Plain . . .	792
“ “ “ Orna.	730, 744-760	“ “ Orna. . . .	236-581
“ “ Trim, Descrip.	159-160	Turnbuckles: Mortise . .	817
Story of an American		“ Rim . . .	816
Industry . . . . .	79-87	Turns, Cupboard: Plain . .	785
Studs and Nails . . . . .	877	“ “ Orna. . . . .	236-581
Sub-Treasury Locks . . . .	674	Typical Lock-sets . . . .	681-731
Surface Butts, Fast Joint . .	774		
Switch Plates . . . . .	920	<b>V</b>	
<b>T</b>		Vestibule Door Sets: Plain	685
Tags for Hotel Keys . . . . .	1077	“ “ “ Orna. . . . .	713
Taking Off Hardware . . . . .	1066	“ Latches . . . . .	653-663
Thumb Knobs: Plain . . . . .	796	<b>W</b>	
“ “ Orna. . . . .	236-581	Wardrobe Locks . . . . .	677
“ Pieces: Plain . . . . .	792	Water Closet Trim . . . . .	818-820
“ “ Orna. . . . .	236-581	Weight of Sashes . . . . .	1087
Towel Hooks . . . . .	795	Window Catches, French: Plain	784
Transom Catches: Plain . . . .	783	“ “ “ Orna. . . . .	236-581
“ “ Orna. . . . .	236-581	Wrought Metal Locks . . . .	127
“ Centers . . . . .	805		
“ Chains . . . . .	812	<b>Y</b>	
“ Lifters . . . . .	813-815	Yale Lock, The . . . . .	71-78

## Numerical Index.

For Alphabetical Index see page 1094.

All Catalogue Numbers of Locks and Hardware used in this volume, unless otherwise specified, are those of the Yale & Towne Manufacturing Company. The Numerical Index below will enable any article, catalogue number of which is known, to be found conveniently.

In the case of Hardware the list numbers indicate mechanical qualities, not design, (and also, usually, size), and apply both to plain and ornamental goods. If used alone the numbers indicate plain bronze or brass hardware; if applied to ornamental hardware the number must invariably be followed by the name of the design.

A list of Designs, alphabetically arranged, will be found on page 244; all articles in the "Cluny" design (selected as typical) are included in the numerical list under their proper numbers, and as "Ornamental."

Lock-sets with Plain Trim are described on pages 682 to 702, and are indexed under the list numbers of the locks (not of the lock-sets).

Lock-sets with Ornamental Trim are described on pages 710 to 731, and in the "Cluny" design are indexed numerically under the title "Ornamental."

The Yale & Towne system of finish symbols is explained on pages 609 to 612, and the desired finish must always be indicated in specifications.

No.	Description.	Page.	No.	Description.	Page
oP	Club Letter Box . . .	799	5	Thumb-piece and Plate	792
1	Blount Door Check . . .	787	6	Blount Door Check . . .	787
	Thumb-piece and Plate . . .	792	7	T-Handle and Plate . . .	792
1P	Club Letter Box . . .	799	8	Lever Handle and Plate	793
2	Blount Door Check . . .	787		T-Handle and Plate . . .	792
	Hallway Letter Box. . .	801	W8 1/4	Cup Escutcheon . . .	706
2P	Club Letter Box . . .	799	9	T-Hdl & Plate, Plain.	792
2 1/2 P	" " " . . .	799		" " " Orn.	735
3	Blount Door Check . . .	787	10	Lever Handle and Plate	793
	Hallway Letter Box . . .	801		T-Handle and Plate . . .	792
4	Blount Door Check. . .	787	11	Lever Handle and Plate	793
	Lock, Rim Dead . . .	618	12	" " " . . .	793
	Thumb-piece and Plate . . .	792		Lock, Rim Dead . . .	618
5	Blount Door Check . . .	787	13	Door Knob. . . . .	704

No.	Description.	Page.	No.	Description.	Page.
13	Lever Handle & Plate	793	50	Shutter Flap . . .	773
W13	Door Knob . . . . .	708	WA 50	Key Blank, . . . .	678
13 <sup>1</sup> / <sub>2</sub>	" " . . . . .	708	50B	Shutter Flap . . .	773
W13 <sup>1</sup> / <sub>2</sub>	" " . . . . .	708	W52	Door Knob . . . . .	709
14	Door Knobs . . . . .	708	52N	Latch, Rim Night	616
	Lever Hdl and Plate .	793	54	" " " . . . . .	615
W14	Door Knob . . . . .	708	55	Door Knob, Orna.	734
15	" " . . . . .	708	W55	" " . . . . .	708
15 <sup>1</sup> / <sub>2</sub>	" " . . . . .	708	55 <sup>1</sup> / <sub>2</sub>	" " Orna.	734
16	" " . . . . .	708	W55 <sup>1</sup> / <sub>2</sub>	" " . . . . .	708
19	Cup Escutcheon . . .	707	56	" " Orna.	734
19 <sup>1</sup> / <sub>4</sub>	" " . . . . .	707	W56	" " . . . . .	708
32	Lock, Rim Dead . . .	617	58	Sliding Door Pull .	789
33	Lever Hdl and Plate .	793	60	Door Knob . . . . .	709
34	" " " . . . . .	793		Shutter Flap . . . .	773
35	" " " . . . . .	793	60B	" " . . . . .	773
	Lever Handles, Orna.	879	66	Latch, Mortise	
W39	Door Knob . . . . .	709		Night . . . . .	627
W39 <sup>1</sup> / <sub>2</sub>	" " . . . . .	709	66G	Asylum Latch . . .	672
40	Door Pull . . . . .	827	66N	Latch, Mortise N't	627
W40	" Knob . . . . .	709	66R	" " " . . . . .	627
41	" Pull . . . . .	827	66S	" " " . . . . .	649
o42	Latch, Rim Night . . .	615	68	Sliding Door Pull .	789
42	Door Pull . . . . .	827	70	Door Knob . . . . .	709
	Latch, Rim Night . . .	615	PA73	Cupboard Lock . . .	674
42 <sup>1</sup> / <sub>2</sub>	Door Pull . . . . .	827	PA74	" " . . . . .	674
43	Door Pull, Plain . . .	827	75	Extension Bolt . . .	765
	" " Orna. . . . .	823	PA75	Cupboard Lock . . .	674
45	" " Plain . . . . .	827	PA76	" " . . . . .	674
	" " Orna. . . . .	823	78	Sliding Door Pul.	789
45S	" " " . . . . .	827	PA79	Cupboard Lock . . .	674
46	" " Plain . . . . .	827	80	Door Knob . . . . .	709
47	" " " . . . . .	827	PA80	Cupboard Knob . . .	674
	" " Orna. . . . .	823	81	Extension Bolt . . .	765
47F	" " Plain . . . . .	827	PA81	Cupboard Lock . . .	674
48	" " " . . . . .	828	84	Hook Sash Lift . . .	806
49	" " " . . . . .	828	85	Door Knob . . . . .	709
	" " Orna. . . . .	823	85 <sup>1</sup> / <sub>2</sub>	" " . . . . .	709



No.	Description.	Page.	No.	Description.	Page
86	Door Knob . . .	709	B166	Transom Lifter . .	815
88	Sliding Door Pull.	789	167	Latch, Mortise Night	627
90	Square Cased Bolt	763	B167	Transom Lifter . .	815
91	Hook Sash Lift .	806	B168	" " . . .	815
	Mortise Door Bolt	763	175	Drawer Pull . . .	938
92	" " " . . .	763	180	" " . . .	938
93	Square Cased Bolt	763	RA180	Drawer Lock . . .	6-6
94	" " " . . .	763	RA181	" " . . .	6-6
95	Mortise Door Bolt	763	183	Espagnolette Bolt .	7-1
96	" " " . . .	763	184	Extension Bolt . .	7-7
WA 102	Wardrobe Lock. .	677	185	Espagnolette Bolt .	7-1
WA 103	" " . . .	677	186	Extension Bolt . .	7-8
P118	Mortise Knob Latch	624	188	" " . . .	7-8
P118 $\frac{1}{2}$	" " " . . .	625	215	Bar Sash Lift. . . .	807
W120	Door Knob . . .	709	222	Door Pull, Orna . .	823
WA 120	Wardrobe Lock. .	677	225	" " Plain . . . .	828
B143	Transom Lifter. . .	815	S230	Desk Lock . . . .	6-6
B144	" " . . .	815	W230	Shutter Bar, Plain	812
146F	Door Pull. . . .	828	234S	Lock, Front Door	663
147	Fast Joint Butt . .	775	234 $\frac{1}{2}$	" " " . . .	660
	Door Pull, Plain . .	828		" Plain Trim . . .	683
	" " Orna . . . .	823		" Orna, " . . . .	711
148	" " Plain . . . .	828	234 $\frac{1}{2}$ R	" Front Door	660
	" " Orna . . . .	823	236 $\frac{1}{2}$	" " " . . .	661
150	Shutter Butt . . . .	772	B243	Transom Lifter . .	815
150B	" " . . . .	772	B244	" " . . . .	815
SA151	Chest Lock . . . .	677	244 $\frac{1}{2}$ S	Lock, Sliding Door	662
SA152	" " . . . .	677	247	Door Pull, Plain . .	828
B153	Transom Lifter. . .	815	250	Loose Joint Butt . .	774
SA153	Chest Lock . . . .	677	S250	Desk Lock . . . .	678
B154	Transom Lifter. . .	815	B253	Transom Lifter . .	815
SA154	Chest Lock . . . .	677	B254	" " . . . .	815
B155	Transom Lifter. . .	815	B255	" " . . . .	815
B156	" " . . . .	815	B256	" " . . . .	815
160	Cabinet Butt. . . .	773	260	Parliament Butt . .	774
160B	" " . . . .	773	265	Fast Joint Butt . .	774
B165	Transom Lifter . . .	815		Surface Butt . . . .	819
166	Latch, Mortise N't	627	B265	Transom Lifter . . .	815

No.	Description.	Page.	No.	Description.	Page.
B266	Transom Lifter .	815		S. D. Handle, Plain	741
B267	“ “ .	815	318B	“ “ “	741
B268	“ “ .	815	320	“ “ “	743
269	Clamp Hinge . .	819	322	Door Pull, Orna.	823
270	Parliament Butt .	774	S322	“ “ Plain .	828
RA272	Sub-Treasury Lock	674	W322	“ “ “ .	828
274S	Latch, Vestibule .	663	324	“ “ “ .	828
274 <sup>1</sup> / <sub>2</sub>	“ “ .	660	332	S. D. Handle, Plain	739
	“ Plain Trim	685		“ “ Orna.	735
	“ Orna. “	713	332B	“ “ Plain	739
274 <sup>1</sup> / <sub>2</sub> R	“ “ .	660	332S	“ “ “	739
279	Clamp Hinge and Spring . . . . .	819	333	“ “ “	739
280	Flush Bolt . . . .	770	334	“ “ “	739
281	“ “ . . . . .	770		Lock, Mortise Dead	629
283	“ “ . . . . .	770	344N	“ “ “	629
	Drawer Pull . . .	938	344R	“ “ “	629
286	“ “ . . . . .	938	344S	“ “ “	649
290	Necked Bolt . . .	763	347	Door Pull, Plain .	828
291	“ “ . . . . .	763	348	Lock, Mortise Dead	629
292	“ “ . . . . .	763	350	Fast Joint Butt .	775
294	Square Bolt . . . .	763	368	Lock, Rim Dead .	617
304	Lock, Mortise Dead	630	380	Extension Bolt . .	765
304R	“ “ “	630	383	“ “ . . . . .	765
304S	Sliding Door Dead	649	384	“ “ . . . . .	767
310	S. D. Handle, Plain	741	RA390	Drawer Lock . . .	676
	“ “ Orna.	745	400	Sash Socket . . . .	804
R310	Drawer Lock . . .	676	410	“ “ . . . . .	804
310B	S. D. Handle . . .	741	412	“ “ . . . . .	804
314	Coat & Hat Hook	794	413	Coat and Hat Hook	794
	S. D. Handle, Plain	741	414	Lock, Store Door	665
	“ “ Orna.	745		“ Plain Trim	702
314B	“ “ Plain	739		“ Orna. “	730
315	“ “ Plain	743	414R	“ Store Door	665
	“ “ Orna.	735	432	“ “ “	665
315B	“ “ Plain	743		“ “ Pl. Trim	739
315S	“ “ Plain	743		“ “ Orna. Trim	745
318	Lock, Mortise Dead	630	432R	“ Store Door .	665

No.	Description.	Page.	No.	Description.	Page.
442	Door Pull, Plain . . .	828	513	Cupboard Lock . . .	675
454	Lock, Store Door . . .	666	513S	" " . . .	675
454R	" " " . . .	666	515	Coat and Hat Hook . . .	794
466	Latch, Mortise Night . . .	627	530	Screen Door Catch . . .	785
466G	" Asylum . . .	672	531	" " " . . .	785
466R	" Mortise Night . . .	627		Locker Lock . . .	675
476G	" Asylum . . .	672	532	Screen Door Catch . . .	785
480	Flush Bolt . . . . .	769	533	Locker Lock . . .	675
480 $\frac{3}{4}$	" " . . . . .	769	S543	Transom Lifter . . .	815
481	" " . . . . .	769	S544	" " . . .	815
482	" " . . . . .	769	S553	" " . . .	815
483	" " . . . . .	769	S554	" " . . .	815
484	" " . . . . .	769	S555	" " . . .	815
485	" " . . . . .	769	S556	" " . . .	815
493	" " . . . . .	770	562	Drawer Lock . . .	675
494	" " . . . . .	770	S565	Transom Lifter . . .	815
499	Cupboard Turn . . . . .	785	S566	" " . . .	815
499 $\frac{1}{2}$	" " . . . . .	785	S567	" " . . .	815
500	" " . . . . .	785	S568	" " . . .	815
500 $\frac{1}{2}$	" " . . . . .	785	571	Drawer Lock . . .	675
501	" Lock. . . . .	675	573	" " . . .	675
	" Turn . . . . .	785	581	Flush Bolt . . . . .	770
502	" " . . . . .	785	582	" " . . . . .	770
502 $\frac{1}{2}$	" " . . . . .	785	583	" " . . . . .	770
503	" " . . . . .	785	584	" " . . . . .	770
505	" Lock . . . . .	675	600	Latch, Mortise Office . . .	647
	French Window Catch . . .	784	605	Transom Catch . . .	785
507	Cupboard Lock . . . . .	675	614	Lock, Office . . . . .	645
510	" " . . . . .	675		" Plain Trim . . . . .	701
	French Window Catch . . .	784		" Orna. " . . . . .	729
510S	Cupboard Lock. . . . .	675	S.D. Handle, Plain . . .	743	
511	" " . . . . .	675	625	Chain Door Fastener . . .	782
511S	" " . . . . .	675	R625	Key Blank, Orna. . . . .	678
512	" Catch. . . . .	782	S643	Transom Lifter . . .	815
	" Lock . . . . .	675	S644	" " . . . . .	815
512S	" " . . . . .	675	650	Extension Bolt . . . . .	765
513	Coat and Hat Hook . . .	794	S653	Transom Lifter . . .	815
	Cupboard Catch . . . . .	782	654	Lock, Office . . . . .	645

No.	Description.	Page.	No.	Description.	Page.
S654	Transom Lifter .	815	736	Lock, Front Door	661
S655	“ “ .	815	745	Letter Hole Plate	797
656	Latch, Office . .	646	747	“ “ “	797
S656	Transom Lifter .	815	749	“ “ “	797
656H	Latch, Office . .	646	750	Lock, Front Door	656
	“ Plain Trim	701		“ Plain Trim	683
	“ Orna. “	729		“ Orna. “	711
658	Lock, Front Door	662		Loose Pin Butt .	777
660	“ Office . .	646	750AF	Lock, Front Door	656
S665	Transom Lifter .	815	750R	“ “ “	657
S666	“ “ .	815	750RAF	“ “ “	657
S667	“ “ .	815	RA754	Key Blank . .	678
S668	“ “ .	815	756	Lock, Rim Knob	620
681	Extension Bolt .	765	RA764	Key Blank. . .	678
	Lock, Rim Knob	619	766	Latch, Vestibule	658
681 1/2	“ “ “	619	766AF	“ “	658
683	Extension Bolt .	765	766R	“ “	659
688	“ “ .	765	766RAF	“ “	659
700	Rim Cupb'd Bolt	784	770	Latch, Office . .	647
701	“ “ “	784		Lock, Plain Trim	701
702	“ Dead Lock	617		“ Orna. “	729
705	Cupboard Bolt .	782		Shutter Knob. .	796
712	Rim Dead Lock	617	770H	Latch, Office . .	647
713	Ceiling Hook . .	795	RA773	Key Blank. . .	678
714	“ “ . .	795	780	Loose Pin Butt .	777
	S.D. Hdle, Plain	743	781	Extension Bolt .	765
RA715	Key Blank . . .	678	782	Rim Night Latch and Lock . . .	622
720	Ceiling Hook . .	795		Extension Bolt .	765
RA724	Key Blank . . .	678	783	Fast Joint Butt .	775
726	Lock Front Door	658	785	Key Blank . . .	678
726AF	“ “ “	658	RA785	Ext. Bolt, Plain .	765
726R	“ “ “	659	788	“ “ Orna .	734
726RAF	“ “ “	659		Latch, Vestibule .	656
732	“ Store Door	666	790	“ Plain Trim	685
	“ Plain Trim	702		“ Orna. “	713
	“ Orna. “	730		“ Vestibule .	656
732R	“ Store Door	666	790AF	“ “	657
RA734	Key Blank . . .	678	790R		

No.	Description.	Page.	No.	Description.	Page
	790RAF Latch, Vestibule . . .	657	894	Cremorne Bolt . . .	88-
RA793	Key Blank. . . . .	678	895	" " . . . . .	88-
800	Cup Escutcheon . . .	707	896	" " . . . . .	888
802	Key Plate, Orna. . . .	735	900	Sliding Door Stop . . .	789
803	" " " . . . . .	735	RA900	Key Blank, . . . . .	6-8
804	" " " . . . . .	735	901	Sliding Door Stop . . .	789
RA804	Key Blank, " . . . . .	678	910	Sash Lock . . . . .	809
805	Key Plate, " . . . . .	735	912	" " . . . . .	809
806	" " " . . . . .	735	914	" " . . . . .	809
810	Cup Escutcheon . . . .	707	915	Card Frame . . . . .	792
811	" " . . . . .	707		Sash Bolt . . . . .	809
RA814	Key Blank . . . . .	678	916	Card Frame . . . . .	792
818	Frame Pulley . . . . .	791	917	" " . . . . .	792
819	" " . . . . .	791		Locking Latch . . . . .	624
820	" " . . . . .	791	918	Card Frame . . . . .	792
824	Cup Escutcheon . . . .	707	919	" " . . . . .	792
RA824	Key Blank . . . . .	678	0967	Lock, Rim Knob . . . . .	622
827	Cup Escutcheon . . . .	707	0967½	" " " . . . . .	622
841	Rim Night Latch . . . .	616	988	Extension Bolt . . . . .	766
845	Letter Hole Plate . . . .	797	990	Flush Ring Pull . . . . .	932
847	" " " . . . . .	797	991	" " " . . . . .	932
849	" " " . . . . .	797	1000	Drawer Knob . . . . .	791
850	Cup Esc'n, Plain . . . .	706		Latch, Mortise Knob . . .	622
	" " Orna. . . . .	904	1000R	" " " . . . . .	622
854	" " Plain . . . . .	706	1001	" " " . . . . .	622
	" " Orna. . . . .	734	1002	" " " . . . . .	622
855	" " Plain . . . . .	707	1004	" " " . . . . .	622
881	Espag'te Bolt, " . . . .	771	1005	Drawer Knob . . . . .	791
	" " Orna. . . . .	888	1008	Latch, Mortise Knob . . .	622
882	" " Plain . . . . .	771	1009	" " " . . . . .	622
	" " Orna. . . . .	888	1010	" " " . . . . .	622
883	" " " . . . . .	888	1012	Dead-Locking Latch . . .	622
884	Extension Bolt . . . . .	767	1040	Druggist Drawer Pull . . .	932
887	" " . . . . .	767	1041	" " " . . . . .	932
888	" " . . . . .	766	1047	Mortise Bolt . . . . .	632
889	" " . . . . .	767	1048	" " . . . . .	632
892	" " . . . . .	766	1049	" " . . . . .	632
893	Cremorne Bolt, . . . . .	887	1050	" " . . . . .	632

No.	Description.	Page.	No.	Description.	Page.
W1052	Drawer Pull . . . .	938	1109	Door Stop . . . .	790
W1053	" " . . . .	938	1110	" " . . . .	790
W1054	" " . . . .	938	1111	" " . . . .	791
W1056	" " . . . .	938	1112	" " . . . .	791
W1057	" " . . . .	938	1112½	" " . . . .	791
W1058	" " . . . .	938	1122	Latch, Store Door . .	664
1060	Mortise Bolt . . . .	631		" Plain Trim . . . .	743
1061	Drawer Pull . . . .	938		" Orna. " . . . .	731
1062	" " . . . .	938	1125	Door Stop . . . .	789
1065	" Knob, Orna. . . .	734	1175	Bookcase Fastener. . .	784
1067	Rim Turnbuckle . . .	816	1178	Mortise Turnbuckle . .	817
1067½	" " . . . .	816	1178R	" " . . . .	817
1068	" " . . . .	816	1179	" " . . . .	817
1068½	" " . . . .	816	1179R	" " . . . .	817
1069	" " . . . .	816	1181	Cupboard Catch . . . .	782
1072	" " . . . .	816	1184	Transom Catch . . . .	783
1073	" " . . . .	816	1186	" " . . . .	783
1074	" " . . . .	816	1187	" " . . . .	783
1075	Slide Bolt . . . .	820	1188	" " . . . .	783
1076	Closet Latch . . . .	820	1189	" " . . . .	783
1078	Mortise Turnbuckle . .	817	1190	Elbow Catch . . . .	784
1079	" " . . . .	817	1191	" " . . . .	784
1080	" " . . . .	817	1193	" " . . . .	784
1081	Rim Turnbuckle . . . .	816	1199	Drop Drawer Pull . . .	939
1086	Indicator Bolt . . . .	819	1200	Bell Pull, Orna . . . .	734
1087	" " . . . .	819		Lock, Mortise Dead . .	629
1088	Cigar & Newsp'r Holder	820	1204	" " " . . . .	628
1089	Cupboard Turn . . . .	785	1213	Bell Pull . . . .	763
1089½	" " . . . .	785	1217	" " . . . .	763
1092	Drawer Pull . . . .	938	1255	" " . . . .	763
1094	" " . . . .	939	1285	" " . . . .	763
1099	" " Orna. . . .	734	1299	Drawer Pull . . . .	938
1103	Door Stop . . . .	790	1300	Lock, Mortise Dead . .	628
1104	" " . . . .	790		Shutter Knob . . . .	796
1105	" " . . . .	790	1305	" " . . . .	796
1106	" " . . . .	790	1308	Lock, Mortise Dead . .	628
1107	" " . . . .	790	1315	Sash Center . . . .	805
1108	" " . . . .	790	1321	Shutter Knob, Orna. . .	940

No.	Description.	Page.	No.	Description.	Page
W1324	Flush Sash Lift . . .	808	1371	Sash Fast . . . . .	806
1325	" " " . . . . .	808	1372	" " . . . . .	806
1330	Transom Chain . . . .	812	1376	" " . . . . .	806
1332	" " . . . . .	812	1379	Casement Adjuster . .	778
1333	" " . . . . .	812	1381	Shutter Bar, Plain . .	812
1335	Sash Center . . . . .	805	1382	" " " . . . . .	812
1339	Hook Sash Lift . . . .	806		" " Orna . . . . .	755
1340	Lock, Mortise Dead . .	628	1383	" " Plain . . . . .	812
1342	Hook Sash Lift . . . .	806	1384	" " " . . . . .	812
1344	Flush Sash Lift, Orna. .	734	1385	" " " . . . . .	812
	" " " Plain . . . . .	808	1386	Casement Adjuster . .	--8
1344B	" " " " . . . . .	808	1387	" " . . . . .	-81
1344L	" " " " . . . . .	808	1388	" " . . . . .	-78
	" " " Orna. . . . .	734	1390	" " . . . . .	-81
1345	Sash Center . . . . .	805		Rim Sash Lift . . . . .	807
1347	Flush Sash Lift, Plain .	808	1391	Casement Adjuster . .	--9
1347B	" " " " . . . . .	808	1392	" " . . . . .	-80
1349	" " " " . . . . .	808	1393	" " . . . . .	--9
1349	" " " Orna. . . . .	734	1394	" " . . . . .	-79
1349B	" " " Plain . . . . .	808	1395	" " . . . . .	-80
1349L	" " " " . . . . .	808	1396	" " . . . . .	-80
1351	Sash Socket, Orna. . . .	735	1397	" " . . . . .	--8
1352	" " Plain . . . . .	804	1398	" " . . . . .	--9
1353	" " " . . . . .	804	1399	" " . . . . .	-81
1354	" " " . . . . .	804	1399 $\frac{1}{2}$	" " . . . . .	-81
1355	Sash Center . . . . .	805	W1400	Sash Fast . . . . .	806
1358	Sash Hook . . . . .	804	1402	Lock, Mortise Knob . .	641
1359	" " . . . . .	804		" Plain Trim . . . . .	697
1360	Bar Sash Lift, Orna. . .	734		" Orna. " . . . . .	721
1362	" " " Plain . . . . .	807	1404	Latch, Mortise Knob . .	626
	" " " Orna . . . . .	734	1410	Push Button, Plain . .	897
1364	" " " Plain . . . . .	807	1413	" " " . . . . .	897
1365	" " " " . . . . .	807		" " Orna. . . . .	897
1367	Door Pull, Plain . . . .	828	1415	" " Plain . . . . .	897
1368	" " " . . . . .	828		" " Orna. . . . .	897
	Drawer Pull . . . . .	939	1416	" " Plain . . . . .	897
1369	" " . . . . .	939		" " Orna. . . . .	897
	Door Pull . . . . .	828	1420	Lock, Mortise Knob . .	637

No.	Description.	Page.	No.	Description.	Page.
1420	Lock, Plain Trim . .	689	1604	Coat and Hat Hook .	795
	“ Orna. “ . . .	717	1606	Towel Hook . . . .	795
1425	Door Knocker, Orna.	873	1607	“ “ . . . . .	795
1440	Lock, Mortise Knob .	639	1608	Coat and Hat Hook .	794
	“ Plain Trim . . .	691	1610	Hall Tree Hook . .	794
	“ Orna. “ . . .	719	1612	“ “ “ . . . . .	794
1442	“ Mortise Knob . .	639	1613	Coat and Hat Hook .	795
	“ Plain Trim . . .	691	1614	Lock, Mortise Office	645
	“ Orna. “ . . .	719		“ Plain Trim . . .	701
1445	“ Mortise Knob . .	640		“ Orna. “ . . .	729
1460	“ “ “ . . . . .	637	1620	Flush Bolt . . . . .	769
1463	Bar Sash Lift . . .	807		Lock, Mortise Knob .	635
1475	Lock, Mortise Knob .	637		“ Plain Trim . . .	687
1481	Cupboard Catch . .	782		“ Orna. “ . . .	715
1485	“ “ . . . . .	782	1620N	“ Mortise Knob . .	634
1486	“ “ . . . . .	782	1640	“ “ “ . . . . .	632
1500	Lock, Mortise Knob .	636	1640R	“ “ “ . . . . .	632
	“ Plain Trim . . .	689	1643	“ “ “ . . . . .	633
	“ Orna. “ . . .	717	1644	“ “ “ . . . . .	633
1504	“ Mortise Knob . .	626	1645	“ “ “ . . . . .	633
	“ Plain Trim . . .	695	1645R	“ “ “ . . . . .	633
	“ Orna. “ . . .	723	1654	“ “ Office . . . .	645
1505	Letter Hole Plate . .	797	1660	Chain Bolt . . . . .	764
	Latch, Mortise Knob .	625	1661	“ “ . . . . .	764
	“ Plain Trim . . .	695	1662	“ “ . . . . .	764
	“ Orna. “ . . .	723	1663	“ “ . . . . .	764
1505½	Letter Hole Plate . .	797	1664	“ “ . . . . .	764
1506	“ “ “ Plain . . .	797	1665	“ “ . . . . .	764
	“ “ “ Orna. . . .	735	1670½	Lock, Hotel Knob . .	642
1506½	“ “ “ Plain . . .	797	1671½	“ “ “ . . . . .	642
	“ “ “ Orna. . . .	735	1672	Foot Bolt. . . . .	764
1507	“ “ “ Plain . . .	797	1674	“ “ . . . . .	764
	“ “ “ Orna. . . .	735	1675	“ “ . . . . .	764
1508	Lock, Asylum . . .	673	1680	Barrel Bolt . . . . .	763
	Letter Hole Plate . .	797		Lock, Hotel Knob . .	642
1508½	“ “ “ . . . . .	797		“ Plain Trim . . .	699
1510	Lock, Asylum . . .	673		“ Orna. “ . . .	727
1603	Coat and Hat Hook .	795	1680½	“ Hotel Knob . . .	642



No.	Description.	Page.	No.	Description.	Page.
1682	Barrel Bolt . . . .	763	1741	Door Pull, Plain . .	828
1684	" " . . . .	763	P1742	Latch, Vestibule . .	653
1685	Lock, Hotel Knob	643	"	Plain Trim	685
	" Plain Trim	699	"	Orna. "	713
	" Orna. "	727	P1742AF	" Vestibule	653
1690	" Hotel Knob	643	P1742R	" " "	653
1695	" " "	644	P1743	" " "	653
	" Plain Trim	699	"	Plain Trim	685
	" Orna. "	727	"	Orna. "	713
1696	" Hotel Knob	644	P1743AF	" Vestibule . .	653
1697	" " "	644	P1743R	" " "	653
1698	" " "	644	1747	Push Plates . . . .	803
1699	" " "	644	1770	Lock, Rim Knob	621
P1700R	Latch, Mortise Knob	624	P1766	Mortise Bolt . . . .	630
1704	Lock, Sliding Door	651	1780	Lock, Flush Rim	670
1704½	" " "	651		Rim Knob Bolt . .	818
P1705	Latch, Mortise Knob	622	1782	Lock, Flush Rim	671
1706	Lock, Sliding Door	650	1783	" Rim Knob	621
	" Plain Trim	697	1784	" Flush Rim	671
	" Orna. "	725	1785	" " "	670
P1706	Latch, Mort. Knob	622	1792	Latch, Elevator . .	643
1706½	Lock, Sliding Door	650	P1793	Lock, Hotel . . . .	641
	" Plain Trim	697	"	Plain Trim	699
	" Orna. "	725	"	Orna. "	727
1708	Locking Latch . . .	810	P1842	" Front Door	652
1710	" " . . . .	810	"	Plain Trim	683
1715	Flush Bolt . . . .	769	"	Orna. "	711
1720	Flush Rim Lock . .	671	P1842AF	" Front Door	652
P1722	Lock, Mort. Knob	634	P1842R	" " "	652
1724	" Sliding Door	651	P1843	" Front Door	652
1726	" " "	650	"	Plain Trim	683
	" Plain Trim	697	"	Orna. "	711
	" Orna. "	725	P1843AF	" Front Door	652
1730	Push Plate, Plain.	803	P1843R	" " "	652
	" " Orna.	735	1876	" Sliding D'r	670
1735	" " Plain	803	P1902½	Latch, " " "	648
1737	Push Plate, Plain	803	P1904½	" " "	648
1740	Door Pull, " "	828	P1905½	" " "	648

No.	Description.	Page.	No.	Description.	Page.
P1918	Lock, Mort. Knob	635	P2430	Lock, Mort. Knob	636
	“ Plain Trim	687		“ Plain Trim.	689
	“ Orna. “	715		“ Orna. “	717
P1918 <sup>3</sup> / <sub>4</sub>	“ Mort. Knob	635	2513	Coat & Hat Hook	795
	“ Plain Trim	687	2516	“ “ “	795
	“ Orna. “	715	P2530	Lock, Mort. Knob	638
2000 <sup>1</sup> / <sub>2</sub>	“ Front Door	655		“ Plain Trim	691
2013	Thumb Knob .	796		“ Orna. “	719
2013 <sup>1</sup> / <sub>2</sub>	“ “ .	796	P2533	“ Store Door	664
2014	“ “ .	796		“ Plain Trim	741
2015	“ “ .	796		“ Orna. “	731
2020	Latch Sets, Plain	743	P2533AF	“ Store Door	664
2024	Thumb Knob .	796	P2533R	“ “ “	664
2025	S. D. Hdl., Plain	743	P2533RAF	“ “ “	664
P2025	Latch, Store Door	665	P2535	“ Mort. Knob	641
P2025R	“ “ “	665		“ Plain Trim	693
P2036AF	Lock “ “	665		“ Orna. “	721
P2036RAF	“ “ “	665	2550	Sash Fast . . .	806
2047	Loose Pin Butt .	776	2614	S. D. Hdl., Plain	743
2095	Flush Sash Lift .	308	2714	“ “ “ “	743
2100	“ “ “	808	2750	Sash Fast . . .	806
2114	Thumb Knob .	796	P2918	Lock, Mort. Knob	636
2115	“ “ Orn.	735		“ Plain Trim	689
P2200	Latch, Mort. Knob	622		“ Orna. “	717
2200 <sup>1</sup> / <sub>2</sub>	“ Vestibule.	655	P2918 <sup>3</sup> / <sub>4</sub>	“ Mort. Knob	636
P2205	Mortise Bolt . .	631		“ Plain Trim	689
P2230	Lock, Mort. Dead	628		“ Orna. “	717
2320	S. D. Hdl., Plain	743	3310	S. D. Hdl., Plain	741
P2330	Lock, Mort. Knob	635	P3310	Lock, Mort. Knob	634
	“ Plain Trim	687		“ Plain Trim	687
	“ Orna. “	715		“ Orna. “	715
2373	Cellar Sash Fast'r	809	3310B	S. D. Hdl., Plain	741
P2400	Latch, Mort. Knob	626	3314	“ “ “	739
	“ Plain Trim	695	3314B	“ “ “	739
	“ Orna. “	723	P3330	Lock, Mort. Knob	634
P2405	“ Mort. Knob	625		“ Plain Trim	687
	“ Plain Trim	695		“ Orna. “	715
	“ Orna. “	723	W3416	Push Button . . .	897

No.	Description.	Page.	No.	Description.	Page.
P3510	Lock, Front Door .	654	P4918	Lock Orna. Trim	721
	“ Plain Trim .	683	P4918 $\frac{3}{4}$	“ Mortise Knob	638
	“ Orn. “ .	711		“ Plain Trim	693
P3510 $\frac{1}{2}$	Latch, Vestibule .	654		“ Orna. “	721
	“ Plain “ .	685	5309	“ Rim Knob	618
	“ Orna. “ .	713	5310	“ “ “ .	618
P3530	Lock, Front Door .	654	5311	“ “ “ .	618
P3530 $\frac{1}{2}$	Latch Vestibule .	654	N5343	Hook Sash Lift . .	806
	“ Plain Trim .	685	N5349	Flush Sash Lift . .	808
	“ Orna. “ .	713	N5850	Cup Escutcheon .	706
P3533	Lock, Front Door .	654	P5918 $\frac{1}{2}$	Lock, Mortise Knob	640
	“ Plain Trim .	683		“ Plain Trim	693
	“ Orna. “ .	711		“ Orna. “	721
P3912 $\frac{1}{2}$	“ Sliding D'r .	650	P5918 $\frac{3}{4}$	“ Mortise Knob	640
	“ Plain Trim .	697		“ Plain Trim	693
	“ Orna. “ .	725		“ Orna. Trim	721
P3918	“ Mort. Knob .	638	6000	Esc'n Plates, Plain	705
	“ Plain Trim .	691	V6000	“ “ “	705
	“ Orna. “ .	719	6042	Latch, Duplex Night	66-
P3918R	“ Mort. Knob .	638	6066	“ “ “	66-
P3918 $\frac{3}{4}$	“ “ “ .	638	6270	“ “ Office	669
	“ Plain Trim .	691	6274	“ “ “	660
	“ Orna. “ .	719	W06310	S. D. Handle, Plain	741
P3918 $\frac{3}{4}$ R	“ Mort. Knob	638	W06310B	“ “ “	741
P3924 $\frac{1}{2}$	“ Sliding Door	650	W06314	“ “ “	739
	“ Plain Trim	697	W06314B	“ “ “	739
	“ Orna. “ .	725	6334	Lock, Duplex Dead	668
P3936 $\frac{1}{2}$	“ Sliding Door	650	6346S	Latch “ Sl. D'r	668
	“ Plain Trim	697	6614	Lock “ Office	669
	“ Orna. “ .	725	6615	“ “ “	669
4300	“ Rim Dead .	617	6616	“ “ “	669
4305	Latch, Secret Gate	616	V6730	Push Plate . . . .	803
4310	“ “ “	616	6850	Plain Cup Escutch'n	706
4620	Lock, Rim Knob	619	6854	“ “ “	706
4620B	“ “ “ .	621	7000	Esc'n Plates, Plain .	705
4630	“ “ “ .	619	V7000	Push Plate . . . .	803
P4918	“ Mortise Knob	638	V7343	Esc'n Plates, Plain .	705
	“ Plain Trim	693		Hook Sash Lift . .	806

No.	Description.	Page.	No.	Description.	Page
W7349	Flush Sash Lift . .	808	C5	Corner Hinge Plate	847
7415	Push Button . .	897	C6	" " "	847
7416	" " . . .	897	M	Middle " "	847
W7850	Cup Escutcheon . .	706	M1	" " "	735
W7854	" " . . .	706	M2	" " "	735
9239	Loose Pin Butt . .	776	M3	" " "	735
9241	" " " . .	776	M4	" " "	847
9808	Fast Joint Butt . .	775	M5	" " "	847
9838	Shutter Butt . . .	772	M6	" " "	847
70850	Cup Escutcheon . .	706	M7	" " "	847
70854	" " . . .	706	S	Strap Hinge . . .	847
71344	Flush Sash Lift . .	808	SI	" " . . .	847
71347	" " " . . .	808	S2	" " . . .	847
71349	" " " . . .	808	T	Top Hinge Plate . .	847
71730	Push Plate . . .	802	T1	" " " . .	847
16/6314	Store Door Handle .	743	T2	" " " . .	847
B	Bottom Hinge Plate	847	TB1	Top & Bot'm Hinge Plt	734
B1	" " " "	847	TB2	" " " " "	734
B2	" " " "	847	TB3	" " " " "	734
C	Corner Hinge Plate	847	TB4	" " " " "	734
C1	" " " "	847	TB5	" " " " "	734
C2	" " " "	847	TB7	" " " " "	734
C3	" " " "	847	TB8	" " " " "	734
C4	" " " "	847			

## Index to Advertisements.

	Page
American Radiator Co., Chicago, . . . . . ( <i>Steam Heating Apparatus</i> ).	7
American Sheet & Tin Plate Co., Pittsburgh, . . . . . ( <i>Roofing Tin, Galvanized and Sheet Iron</i> ).	4
Bommer Bros., Brooklyn, . . . . . ( <i>Spring Hinges</i> ).	11
Colt Co., J. B., New York, . . . . . ( <i>Acetylene Gas Apparatus</i> ).	10
Columbia Hardware Co., Cleveland, . . . . . ( <i>Spring Hinges, Etc.</i> ).	15
Fuller Co., George A., New York, . . . . . ( <i>Fireproof Building Construction</i> ).	6
Gamewell Auxiliary Fire Alarm Co., The, New York, . . . . . ( <i>Interior Fire Alarms</i> ).	12
General Fire Extinguisher Co., Providence, . . . . . ( <i>Automatic Sprinkler Equipment</i> ).	1
Hammacher, Schlemmer & Co., New York, . . . . . ( <i>Hardware and Tools</i> ).	13
Minett Varnish Co., New York, . . . . . ( <i>Japans and Varnishes</i> ).	13
New York Belting & Packing Co., Ltd., New York, . . . . . ( <i>Interlocking Rubber Tiling</i> ).	14
Peirce, John, New York, . . . . . ( <i>Granite Work, Monumental Structures</i> ).	4
Roebbling Construction Co., The, New York, . . . . . ( <i>Fireproof Concrete Construction</i> ).	8
Standard Publishing Co., The, Boston, . . . . . ( <i>Handbook of Fire Protection</i> ).	12
Standard Sanitary Mfg. Co., Pittsburgh, . . . . . ( <i>Porcelain and Enamel Ware</i> ).	3
Stanley Works, The, New Britain, Conn., . . . . . ( <i>Wrought Steel Butts, Etc.</i> ).	2
Voigtmann & Co., Chicago and New York, . . . . . ( <i>Metal Frames for Wire Glass</i> ).	9
Westinghouse Electric & Mfg. Co., Pittsburgh, . . . . . ( <i>Electric Apparatus generally</i> ).	5
Wiley & Sons, John, New York, . . . . . ( <i>Publishers</i> ).	15

**Engineers and Contractors for**  
**The Grinnell**  
**Automatic Fire Apparatus**

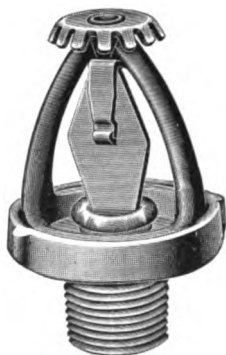

**The Automatic Sprinkler**  
**The Automatic Valve for Dry Pipe Systems**  
**The Automatic Alarm Valve**

¶ An approved system of automatic sprinklers soon pays for itself by a saving of 25 to 50 per cent. on the cost of insurance.

¶ Sprinklers were first installed in textile factories, but are now extensively employed to protect Dry Goods and other Stores, Hotels and Office Buildings, Power Houses, Rubber and Celluloid Works, Saw and Planing Mills, Theatres, etc., etc.—in short, we can recall no class of insurable risk which has not been equipped with our protective apparatus.

**General Fire Extinguisher Co.**

**Executive Offices, Providence, R. I.**

# The Stanley Works

New Britain, Conn.

79 Chambers Street, New York

---

✦ Makers of ✦

Wrought Steel Butts, Hinges, Door  
Bolts, Shelf Brackets, etc.

---

## Ball Bearing Hinges



(Cut of Washer used in Ball Bearing Hinges)

## in Wrought Bronze and Steel

Entire weight of door rests on the balls in  
the two washers.

No possible sagging of door.

Door swings easily and noiselessly.

Washer so constructed it does not come  
apart in use.

---

Send for Artistic Booklet

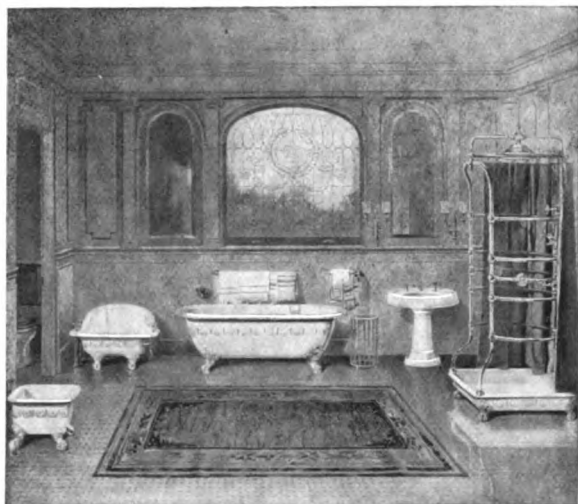

# **"Standard"**

**PORCELAIN ENAMELED BATHS**

AND

**SANITARY WARE**

are luxurious and as dainty as fine china ware. They are the preferred equipment of discriminating householders. : : :

**EXHIBITED AND SOLD EVERYWHERE**

---

*100 page Catalogue sent on request*

---

**Standard Sanitary Mfg. Co.**

**PITTSBURGH, U. S. A.**



*"The Best is the Cheapest"*



Trade Mark

The **BEST ROOF** is made of

## **MF Roofing Tin**

It has held during the last sixty years the **Most Favored** and leading place in the race for superiority in Roofing Materials



The **BEST METAL CORNICES**

are made of

## **Apollo Best Bloom Galvanized Sheets**

The trade mark signifies the highest standard of reliability. The easy working qualities of the Metal make it the favorite of the Metal Worker. When in need of galvanized sheets for construction work, don't be satisfied with substitutes, insist on the genuine.

Our Products are for sale by all Metal Houses

**American Sheet & Tin Plate Company**  
**PITTSBURGH, PA.**

# **John Peirce**

## **Granite and General Contractor**

**277 Broadway, New York City**

### **GRANITE WORK of the HIGHEST GRADE**

—Builder of the following Monumental Structures—

☐ New Hall of Records, New York City; New U. S. Custom House, New York City; Main Power House Interborough Rapid Transit Co., New York City; U. S. Post Office, Chicago, Ill.; U. S. Post Office, Indianapolis, Ind.; New Granite Dry Dock, U. S. Navy Yard, Portsmouth, N. H.; Academic Group, U. S. Naval Academy, Annapolis, Md.; U. S. Post Office, Buffalo, N. Y., and other large buildings.

# Westinghouse

## Generators, Motors and Auxiliary Apparatus

For generating and applying electric power  
in Hotels, Office Buildings, Public Buildings  
and Apartment Houses.

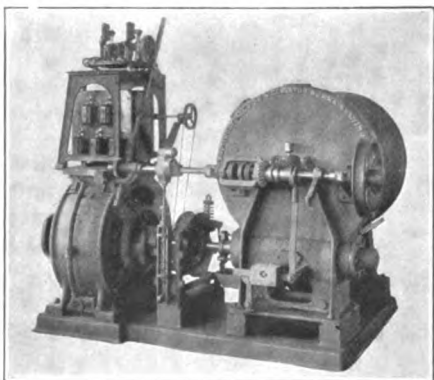

Type S Motor Driving Elevator Hoist

Characterized by the excellency of construction and  
efficiency of operation which the name Westinghouse  
implies.

For Particulars Address

**Westinghouse Electric and Mfg. Co.**

Sales Offices in All Large Cities

Pittsburg, Pa.

For Canada: Canadian Westinghouse Co., Limited

THE FULLER BUILDING (FLATIRON)

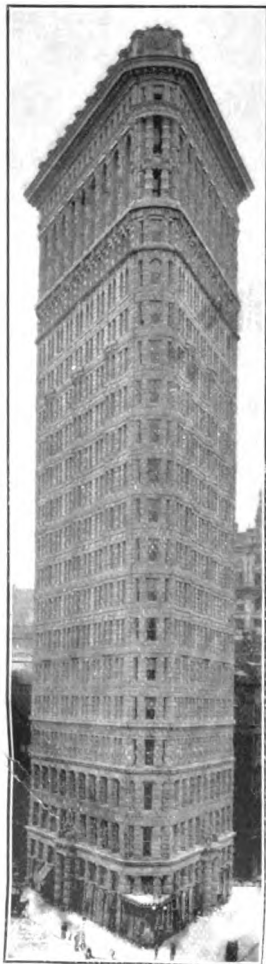

# George A. Fuller Company

---

---

## FIREPROOF BUILDING CONSTRUCTION

---

---

—OFFICES—

**NEW YORK** Fuller Building  
**PHILADELPHIA** North American Building  
**BOSTON** Board of Trade  
**CHICAGO** Marquette Building  
**BALTIMORE** 203 North St.  
**WASHINGTON** Home Life Ins. Building  
**PITTSBURG** Farmers' Bank Building  
**ST. LOUIS** Fullerton Building

---

---

We are the Builders of  
over Two Hundred Fireproof  
Office Buildings, Hotels,  
Apartment Buildings, Depart-  
ment Stores, Clubs and  
Theatres in the principal  
cities of the U. S. A.

# A Classic in Iron

Prominent in the line of finer ornamental hardware for homes, etc., stands the VERONA Radiator. Just right for halls, parlors, etc. We have thirty-five other artistic patterns, plain and ornate.

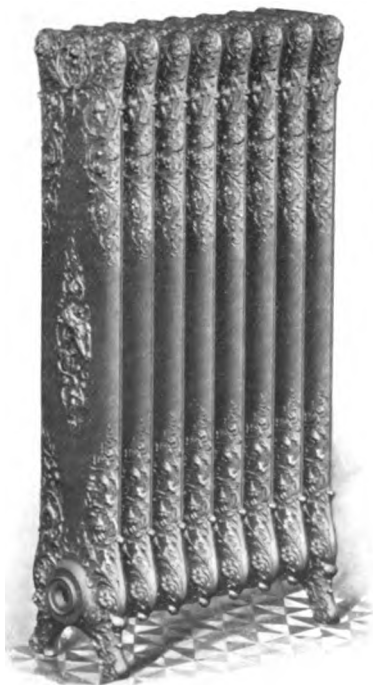

**AMERICAN RADIATOR COMPANY**

Catalogues mailed free - DEPT. 55, CHICAGO

*A System of  
Fire-Proofing that is Fire-Proof*

**THE ROEBLING SYSTEM**

is now the recognized standard of fire proof construction. It has been used in over 700 buildings. It is the only system that has withstood actual conflagrations without injury and without the necessity of repairing the construction. It has been adopted for the largest department stores, offices and apartment hotels in the world.       :       :       :       :       :

*72 page Illustrated Catalogue on application*

*The Roebling Construction Co.*

Fuller Building

Broadway and 23rd St., New York

*Philadelphia*

*Boston*

*Buffalo*

*Cleveland*

*Pittsburg*

*Chicago*

*St. Louis*

*Seattle*

*San Francisco*



Increases Rent Values

—  
Fire Barriers Affording  
Life and Ventilation

—  
Decreases Fire  
Premiums

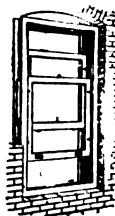

The Voigtmann Standard  
Automatic Closing and Lock-  
ing Windows a Specialty.

The Voigtmann Adjust-  
able Guide Window. Interior  
View showing Sash Weights.

---

---

# *Voigtmann & Co.*

---

---

Manufacturers under Patents of  
THEIR SPECIALTIES IN

## *Metallic Window Frames and Sashes*

*For Carrying Mississippi Wire Glass*

In accordance with the requirements demanded  
by Fire Insurance Underwriters and Building  
Departments. Universally accepted in lieu of  
common windows and fire shutters. : : :

CHICAGO

42 - 54 East Erie Street

NEW YORK

430 West 14th Street

427 West 13th Street

New York Telephone, 771 Chelsea

**COLT**  
TRADE MARK.



# Acetylene

=====*The*=====  
*Ideal Illuminant*

solves the problem of  
lighting country houses.

☐ Cheaper, better and more efficient than  
any other artificial illuminant. : : : : :

Send for Catalogue 10.

## J. B. Colt Company

21 Barclay Street, New York

Philadelphia

Chicago

Los Angeles



Residence of Mr. Henry J. Hardenburgh, Bernardsville, N. J.  
Lighted by "Colt" Acetylene.

---

# BOMMER SPRING HINGES

ARE

## Quality Goods

**But Cost No More than Inferior Kinds**

*Gold Medal, St. Louis, 1904*

*Gold Medal, Paris, 1900    Gold Medal, Buffalo, 1901*

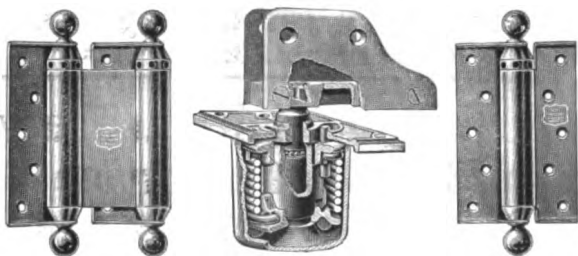

Spring Hinges lead the strenuous life in Builders' Hardware; no other article in the entire line endures such wear and tear; therefore don't err in judgment, use Bommer Spring Hinges, they stand up to their work.

---

**Bommer Bros. Mfrs., Brooklyn, N.Y.**

**Established 1876**



---

# HANDBOOK of FIRE PROTECTION for IMPROVED RISKS

By EVERETT U. CROSBY and HENRY A. FISKE

¶ A Treatise on Fire Preventing Methods and Fire Fighting Devices. ¶ A Work for Architects, Engineers, Manufacturers and all Interested in Reducing the Fire Hazard. ¶ A Compendium of Underwriters' Rules Requirements, Regulations, Standards, etc. : : : .

363 Pages. Copiously Illustrated. Bound in Limp Leather.

Price, THREE DOLLARS, postage prepaid

Address—

**Standard Publishing Co.**

60 India Street, Boston, Mass.

---

## The Gamewell Auxiliary Fire Alarm Service

¶ Furnishes any desired number of interior stations from which fire alarms can be instantaneously transmitted to Fire Department Headquarters.

¶ This service is installed in thousands of hotels, hospitals, office buildings, as well as in mercantile and manufacturing concerns in New York and many other cities.

¶ For particulars address

**The Gamewell Auxiliary Fire Alarm Co.**

19 Barclay Street, New York City

---

# Open Steel Triangles for Draughtsmen

Other good things for Draughtsmen, Architects, Builders and for all users of Hardware and Tools.

**HAMMACHER, SCHLEMMER & CO.**

**HARDWARE, TOOLS & SUPPLIES**

NEW YORK SINCE 1848

If it's Hardware or Tools, and hard to find, try H. S. & Co.

New Home, 4th Ave. & 13th St., Block South of Union Square

====High Grade====

## Baking Japans and Varnishes

====  
"The Old Reliable"  
====

**Minett Varnish Company**

**129 Pearl Street**

Established 1844

**New York**

# Interlocking Rubber Tiling

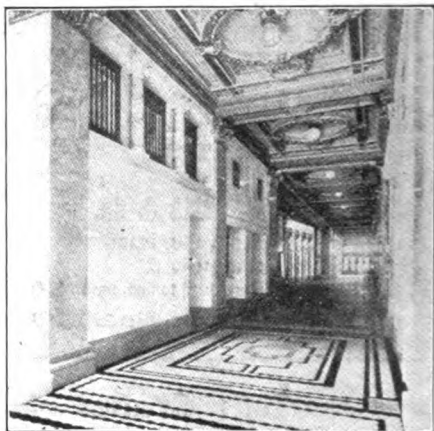

As laid by us in Corridor of Empire Bldg., New York

Is noiseless, non-slippery, waterproof and thoroughly sanitary, more durable than stone or earthen tiles, elegant in appearance, manufactured in a carefully selected variety of colors. Endorsed by the best architects and engineers.

A perfect floor for business offices, banking-rooms, court-rooms, vestibules, halls, billiard-rooms, smoking-rooms, cafes, libraries, churches, hospitals, hotels, bath-rooms, kitchens, etc.

Samples, estimates and special designs furnished upon application.

**Sole Manufacturers**

**NEW YORK BELTING  
and PACKING CO., Ltd.**

**91 @ 93 Chambers St., NEW YORK**

PHILADELPHIA, 724 Chestnut St. INDIANAPOLIS, 229 S. Meridian St.  
BOSTON, . . . 232 Summer St. CHICAGO, . . . . . 150 Lake St.  
BALTIMORE, . . 41 S. Liberty St. ST. LOUIS, . . . 411 N. Third St  
SAN FRANCISCO, 605-607 Mission St.

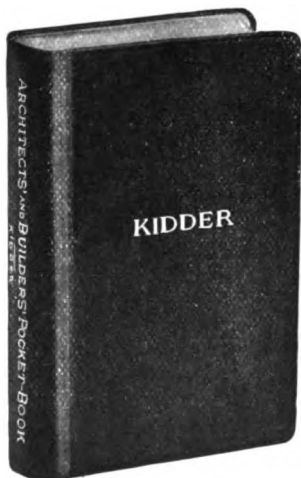

***Now Ready***

The Fourteenth Edition of  
**KIDDER'S ARCHITECTS' AND  
BUILDERS' POCKET-BOOK**

Twentieth Thousand  
16mo. xix X 1656 pages  
1000 figures  
Morocco . . \$5.00

—  
**JOHN WILEY & SONS**  
43 and 45 East 19th Street  
New York City

---

**“COLUMBIAN”**  
**SHEET STEEL HINGES**

Made in all finishes, including brass and bronze

—  
Write for catalogue and prices on new lines

—  
**THE COLUMBIAN  
HARDWARE COMPANY**  
**CLEVELAND, O.**

**New York**  
**San Francisco**

**Chicago**  
**London**

# The Yale & Towne Mfg. Co.

---

MAKERS OF

The Yale Locks,  
Builders' Hardware,  
Art Metal Work,  
Padlocks,  
Blount Door Checks,  
Cabinet Locks,  
Trunk Locks,  
Yale Bank Locks,  
Yale Lock Boxes,  
Chain Blocks, Etc.

---

New York City

General Offices, 9-11-13 Murray St.  
Exhibit Rooms, 242 Fifth Avenue

*W.S.* Local Offices

Chicago . . . . .	131 Wabash Avenue
Philadelphia . . . . .	630 Witherspoon Bldg.
Boston . . . . .	12 Pearl Street
San Francisco . . . . .	Hayward Building

Works: Stamford, Conn.

FS













**THE NEW YORK PUBLIC LIBRARY  
REFERENCE DEPARTMENT**

**This book is under no circumstances to be  
taken from the Building**

Call no. 419